

# Pecyn Dogfen Gyhoeddus

**Gareth Owens LL.B Barrister/Bargyfreithiwr**

Chief Officer (Governance)

Prif Swyddog (Llywodraethu)



Swyddog Cyswllt:

Nicola Gittins 01352 702345

nicola.gittins@flintshire.gov.uk

At: Cyng Ian Roberts (Arweinydd)

Y Cynghorwyr: Sean Bibby, Chris Bithell, Mared Eastwood, David Healey,  
Dave Hughes, Paul Johnson, Christine Jones a Billy Mullin

10 Ionawr 2024

Annwyl Gynghorydd,

**RHYBUDD O GYFARFOD RHITHIOL**  
**CABINET**  
**DYDD MAWRTH, 16EG IONAWR, 2024 10.00 AM**

Yn gywir

Steven Goodrum  
Rheolwr Gwasanaethau Democrataidd

Bydd y cyfarfod yn cael ei ffrydio'n fyw ar wefan y Cyngor. Bydd y ffrydio byw yn dod i ben pan fydd unrhyw eitemau cyfrinachol yn cael eu hystyried. Bydd recordiad o'r cyfarfod ar gael yn fuan ar ôl y cyfarfod ar <https://flintshire.publici.tv/core/portal/home>

Os oes gennych unrhyw ymholiadau, cysylltwch ag aelod o'r Tîm Gwasanaethau Democrataidd ar 01352 702345.

## R H A G L E N

### 1 YMDDIHEURIADAU

**Pwrpas:** Derbyn unrhyw ymddiheuriadau.

### 2 DATGAN CYSYLLTIAD

**Pwrpas:** I derbyn datganiad o gysylltiada chynghori's Aelodau yn unol a hynny.

### 3 COFNODION (Tudalennau 7 - 16)

**Pwrpas:** Cadarnhau cofnodion y cyfarfodydd a 19 Rhagfyr 2023.

YSTRID YR ADRODDIADAU CANLYNOL

### ADRODDIAD STRATEGOL

### 4 STRATEGAETH ARIANNOL TYMOR CANOLIG A CHYLLIDEB 2024/25 - SETLIAD DROS DRO LLYWODRAETH LEOL CYMRU (Tudalennau 17 - 28)

Adroddiad Rheolwr Cyllid Corfforaethol - Aelod Cabinet Cyllid, Cynhwysiant, Cymunedau Cryf gan gynnwys Gwerth Cymdeithasol a Chaffael

**Pwrpas:** I roi'r wybodaeth ddiweddaraf ac amcangyfrif o'r gyllideb ar gyfer 2024/25 a goblygiadau Setliad Dros Dro Llywodraeth Leol Cymru a gafwyd ar 20 Rhagfyr.

### 5 ADRODDIAD CANOL BLWYDDYN AR BERFFORMIAD CYNLLUN Y CYNGOR 2023 / 24 (Tudalennau 29 - 134)

Adroddiad Prif Weithredwr - Aelod Cabinet Llywodraethu a Gwasanaethau Corfforaethol gan gynnwys Iechyd a Diogelwch ac Adnoddau Dynol

**Pwrpas:** Adolygu'r cynnydd a wnaed yn erbyn blaenoriaethau a nodwyd yng Nghynllun y Cyngor 2023 / 28.

### 6 STRATEGAETH TIR HALOGEDIG (Tudalennau 135 - 208)

Adroddiad Prif Swyddog (Cynllunio, Amgylchedd ac Economi) - Aelod Cabinet Cynllunio, Iechyd y Cyhoedd a Gwarchod y Cyhoedd

**Pwrpas:** Bod y Cabinet yn cymeradwyo Strategaeth Archwilio Tir Halogedig.

**7 CYNNYDD AR Y PROSIECT ARCHIF GOGLEDD DDWYRAIN CYMRU (AGDDC)** (Tudalennau 209 - 262)

Adroddiad Prif Swyddog (Addysg ac Ieuenctid) - Cabinet Member for Education, Welsh Language, Culture and Leisure

**Pwrpas:** Diweddarau'r Cabinet ar ddatblygiadau'r prosiect Archif AGDdC.

**ADRODDIADAU GWEITHREDOL**

**8 MONITRO CYLLIDEB REFENIW 2023/24 (MIS 8)** (Tudalennau 263 - 288)

Adroddiad Rheolwr Cyllid Corfforaethol - Aelod Cabinet Cyllid, Cynhwysiant, Cymunedau Cryf gan gynnwys Gwerth Cymdeithasol a Chaffael

**Pwrpas:** Mae'r adroddiad misol rheolaidd hwn yn darparu'r wybodaeth ddiweddaraf am fonitro cyllideb refeniw 2023/24 Cronfa'r Cyngor a'r Cyfrif Refeniw Tai. Mae'r sefyllfa yn seiliedig ar incwm a gwariant gwirioneddol fel yr oedd hyd at Fis 8 a rhagamcan ymlaen i ddiwedd y flwyddyn.

**9 DIWYGIO TRETH Y CYNGOR – YMGYNGHORIAD CAM 2 LLYWODRAETH CYMRU** (Tudalennau 289 - 304)

Adroddiad Prif Swyddog (Llywodraethu) - Aelod Cabinet Cyllid, Cynhwysiant, Cymunedau Cryf gan gynnwys Gwerth Cymdeithasol a Chaffael

**Pwrpas:** Darparu gwybodaeth ac ymateb argymelledig i'r Cabinet ar gyfer ymgynghoriad cam 2 Llywodraeth Cymru ynghylch Diwygio Treth y Cyngor.

**10 POLISI GOLEUADAU STRYD 2023-2028** (Tudalennau 305 - 318)

Adroddiad Prif Swyddog (Stryd a Chludiant) - Dirprwy Arweinydd y Cyngor a'r Aelod Cabinet Gwasanaethau Stryd a'r strategaeth cludiant rhanbarthol

**Pwrpas:** Ceisio cymeradwyaeth y Cabinet ar gyfer Polisi Goleuadau Stryd diwygiedig y Cyngor.

11 **COFEBION PERYGLUS YM MYNWENTYDD SIR Y FFLINT** (Tudalennau 319 - 328)

Adroddiad Prif Swyddog (Stryd a Chludiant) - Dirprwy Arweinydd y Cyngor a'r Aelod Cabinet Gwasanaethau Stryd a'r strategaeth cludiant rhanbarthol

**Pwrpas:** Ceisio cymeradwyaeth ar gyfer dull amgen a pharhaol o wneud cofebion yn ddiogel os nad yw'r gofeb yn cael ei thrwsio gan berchennog cofrestredig y bedd, yn ogystal â thynnu ymylfeini sydd wedi torri neu eu gwneud nhw'n saff os ydynt mewn cyflwr gwael.

12 **ADOLYGU FFFIOEDD GWASANAETH LARWM** (Tudalennau 329 - 350)

Adroddiad Prif Swyddog (Tai ac Asedau) - Aelod Cabinet Tai ac Adfywio

**Pwrpas:** I amlinellu'r cynnig i adennill y costau llawn ar gyfer gwasanaeth larymau'r Cyfrif Refeniw Tai.

13 **POLISI RHEOLI TAI AC YMDDYGIAD GWRTHGYMDEITHASOL** (Tudalennau 351 - 384)

Adroddiad Prif Swyddog (Tai ac Asedau) - Aelod Cabinet Tai ac Adfywio

**Pwrpas:** Rhoi trosolwg o'r newidiadau sydd wedi cael eu gwneud i Bolisi Rheoli Tai a Pholisi Ymddygiad Gwrthgymdeithasol er mwyn ymateb i Ddeddf Rhentu Cartrefi Cymru 2016.

14 **BRYN Y BEILI, YR WYDDGRUG** (Tudalennau 385 - 392)

Adroddiad Prif Swyddog (Cynllunio, Amgylchedd ac Economi) - Aelod Cabinet Newid Hinsawdd a'r Economi

**Pwrpas:** Rhoi'r wybodaeth ddiweddaraf am ddatblygiad y cyfleusterau ym Mryn y Beili yn Yr Wyddgrug.

15 **DIWEDDARIAD AR YR ADOLYGIAD O RWYSTRAU MYNEDIAD** (Tudalennau 393 - 440)

Adroddiad Prif Swyddog (Cynllunio, Amgylchedd ac Economi) - Aelod Cabinet Newid Hinsawdd a'r Economi

**Pwrpas:** Cytuno ar gyflwyniad gwelliannau i fynediad ar Lwybr Arfordir Cymru.

16 **YMARFER PWERAU DIRPRWEDIG** (Tudalennau 441 - 442)

**Pwrpas:** Rhoi'r wybodaeth ddiweddaraf am effaith diwygiadau lles a'r Gwaith sy'n mynd rhagddo i'w lliniaru.

**RHAGLAN GWAITH I'R DYFODOL - Y CYNGOR SIR, CABINET,  
PPWYLLGOR ARCHWILIO A'R WYLLGOR TROOLWG A CHRAFFU - ER  
GWYBODAETH**

**DEDDF LLYWODRAETH LEOL (MYNEDIAD I WYBODAETH) 1985 -  
YSTYRIED GWAHARDD Y WASG A'R CYHOEDD**

Mae'r eitem a ganlyn yn cael ei hystyried yn eitem eithriedig yn rhinwedd Paragraff(au) 14 Rhan 4 Atodiad 12A o Ddeddf Llywodraeth Leol 1972 (fel y cafodd ei diwygio)

Mae'r adroddiad yn ymwneud â materion ariannol neu fusnes unrhyw berson penodol (y Cyngor) ac mae'r buddiant mewn dal y wybodaeth yn ôl yn drech na'r buddiant i'w datgelu tra'n aros i'r mater gael ei ddatrys.

**17 ADOLYGIAD CONTRACT FFLYD (Tudalennau 475 - 522)**

Adroddiad Prif Swyddog (Stryd a Chludiant) - Dirprwy Arweinydd y Cyngor a'r Aelod Cabinet Gwasanaethau Stryd a'r strategaeth cludiant rhanbarthol

**Pwrpas:** Mae'r adroddiad yn darparu diweddariad i'r Cabinet ar y Contract Fflyd.

***Sylwch, efallai y bydd egwyl o 10 munud os yw'r cyfarfod yn para'n hirach na dwy awr.***

Mae'r dudalen hon yn wag yn bwrpasol

# Eitem ar gyfer y Rhaglen 3

## **CABINET** **19<sup>TH</sup> DECEMBER 2023**

Minutes of the meeting of the Cabinet of Flintshire County Council held virtually via Zoom on Tuesday 19<sup>th</sup> December 2023.

### **PRESENT: Councillor Dave Hughes (Deputy Leader in the Chair)**

Councillors: Sean Bibby, Chris Bithell, Mared Eastwood, Dave Healey, Paul Johnson, Christine Jones and Billy Mullin.

### **IN ATTENDANCE:**

Chief Executive, Chief Officer (Governance), Chief Officer (Planning, Environment and Economy), Chief Officer (Social Services), Chief Officer (Housing and Communities), Corporate Finance Manager, Corporate Manager – Capital Programme and Assets, Corporate Manager, People and Organisational Development, Strategic Finance Manager and Team Leader – Democratic Services.

### **OTHER MEMBERS IN ATTENDANCE:**

Councillors: Bernie Attridge and David Coggins Cogan.

### **APOLOGIES:**

Councillors: Billy Mullin and Ian Roberts.

## **87. DECLARATIONS OF INTEREST**

None.

## **88. MINUTES**

The minutes of the meeting held on 21<sup>st</sup> November were submitted and confirmed as a correct record.

### **RESOLVED:**

That the minutes of the meeting be approved as a correct record.

## **89. MEDIUM TERM FINANCIAL STRATEGY (MTFS) AND BUDGET 2024/25**

Councillor Johnson introduced the report which provided an update on the Council's revenue budget position for the 2024/25 financial year in advance of the receipt of the Welsh Local Government Provisional Settlement on 20<sup>th</sup> December.

The revised cost pressures and cost reduction options to date were referred to the relevant Overview and Scrutiny Committees throughout October, at which time there was an estimated funding gap of £14.042m. Feedback from those meetings was reported back to Corporate Resources Overview and Scrutiny Committee on 16<sup>th</sup> November. In addition, two Member workshops were held on 5<sup>th</sup> and 10<sup>th</sup> October.

The report set out the changes to the 2024/25 additional budget requirement since the last reported position in September. The report also updated on the progress made to identify solutions to bridge the remaining budget gap. Following receipt of the provisional settlement a briefing would be provided to Members to advise of the impact on the overall 2024/25 budget position.

Whilst progress had been made it should be noted that the Council still had a major challenge to identify the remaining solutions that would enable it to agree a legal and balanced budget by March next year which it continued to address with urgency.

The Chief Executive reiterated the bleak position across Wales going into 2024/25. He commented on the work on planning that had commenced on delivering a strategic programme of service transformation to ensure that the Council was developing cost reductions over the next five years in order to protect its ongoing future financial position and ensure it was further prepared for inevitable future budget challenges. Whilst those workstreams were to provide financial support from 2025/26 onwards, they did not assist with the immediate budget challenges for 2024/25.

Areas that could fall in the scope of transformation work were outlined in the report. The list was not exhaustive and future engagement with Members would be important to ensure that there was an opportunity to contribute and positively influence the programme of activity and ensure that it was progressed on a timely basis.

The Corporate Finance Manager explained that the biggest new pressure was the increase in the cost of Free School Meals (term time) as well as increased demand in the current financial year.

With a remaining gap of £11m, he reiterated the comments of the Chief Executive and the areas that needed to be looked at as part of the Strategic Programme of Transformation. Each portfolio was also looking at how they could achieve 5% of efficiencies.

**RESOLVED:**

- (a) That the revised additional budget requirement for the 2024/25 financial year be received and noted; and
- (b) That the progress made and the ongoing work on budget solutions that continue to be urgently addressed to enable the Council to set a legal and balanced budget by March 2024 be noted.

**90. HOUSING REVENUE ACCOUNT (HRA) 30 YEAR FINANCIAL BUSINESS PLAN**

Councillor Bibby introduced the report which presented the draft Housing Revenue Account (HRA) 30-year Financial Business Plan and the proposed HRA Budget for 2024/25.



The strategic context for this year's HRA budget setting included the following:

- Ensure affordability for tenants is at the core of our considerations
- Continued drive to ensure all service costs are efficient and that value for money can be achieved
- Ensure the treasury management strategy continues to meet the HRA's new and ongoing borrowing requirements
- Setting a balanced budget with a minimum of 3% surplus revenue over expenditure
- Maximisation of revenue efficiencies to minimise the borrowing required to meet Welsh Housing Quality Standards (WHQS)
- Delivery of new build Council housing
- Continued drive to ensure homes are Energy Efficient and explore Decarbonisation
- Provision of adequate ongoing capital to maintain WHQS levels.

The Chief Officer (Housing and Communities) explained that the report had been submitted to Community and Housing Overview and Scrutiny Committee and feedback was that the service charge for aerials be frozen which was reflected in the Cabinet report and recommendation (d), and that a hardship fund be set up which was reflected in the report recommendation (e). She added at the Welsh Government (WG) rent cap for social housing was 6.7%, with Flintshire's proposed increase being 6.5%. The garage rent increase was also lower than the WG cap.

The Strategic Finance Manager expressed the need to focus on affordability. WHQS 2 had just been announced which proposed to reduce the carbon emissions from social housing and in doing so, contribute to the Welsh target of Net Zero Carbon. There was no funding from WG to support that so the Council needed to ensure the HRA could cover the cost of those works.

**RESOLVED:**

- (a) That the Housing Revenue Account budget for 2024/25 be considered;
- (b) That the proposed minimum rent increase of 6.5% be approved;
- (c) That the garage rent increase of 6.5% be approved;
- (d) That the increase in service charges to full cost recovery with the exception of aerial charges which will be frozen until a new contract is negotiated be approved;
- (e) That the tenant hardship fund be topped up to a cap of £0.350m from any surplus reserves generated in year, if required; and
- (f) That the proposed Housing Revenue Account Capital Programme for 2024/25 be approved.

**91. DRAFT STRATEGIC EQUALITY PLAN 2024-28**

The Corporate Manager, Capital Programme and Assets, introduced the report which presented the Council's draft equality objectives and Strategic Equality Plan 2024-28 for endorsement prior to formal consultation.

All devolved public authorities in Wales were required by the Equality Act 2010 (Statutory Duties) (Wales) Regulations 2011 to publish equality objectives and a Strategic Equality Plan every four years.

Engagement must take place with people with protected characteristics when setting equality objectives and preparing and reviewing the Strategic Equality Plan. The aim of the Strategic Equality Plan was to reduce inequalities and ensure the delivery of positive outcomes for people with protected characteristics.

The Strategic Equality Plan for the period 2024-28 must be finalised and published by 1st April 2024.

The proposed equality objectives for 2024-28 were:

- Improve health, well-being and social care outcomes, including outcomes for older people and disabled people
- Reduce gaps in educational attainment between protected groups and implement strategies to improve well-being
- Ensure equal pay within the workplace by having fair, open and transparent grading and salary strategies in place
- Improve personal safety for all protected groups
- Increase access to services and decision making for all protected groups
- Improve living standards of people with different protected characteristics
- Reduce the impact of poverty and embed the Socio-economic Duty within the organisation

Consultation would begin in January for a period of six weeks following which a report would be submitted to Corporate Resources Overview and Scrutiny Committee and Cabinet.

When considered at Corporate Resources Overview and Scrutiny Committee it was noted that the email address within the document was incorrect. That would be rectified prior to the consultation commencing.

**RESOLVED:**

- (a) That the draft Strategic Equality Plan 2024-28 be approved before wider consultation with stakeholders, members of the public, and employees; and
- (b) That the draft Strategic Equality Plan 2024-28 be presented to Corporate Resources Overview and Scrutiny Committee for their consideration and review.

## **92. REVENUE BUDGET MONITORING REPORT 2023/24 (MONTH 7)**

Councillor Johnson introduced the report which provided Members with the first detailed overview of the budget monitoring position for the 2023/24 financial year for the Council Fund and Housing Revenue Account and presented the position, based on actual income and expenditure as at Month 7.

The projected year end position was as follows:

### **Council Fund**

- An operating deficit of £3.671m (excluding the impact of the pay award which would need to be met by reserves – currently estimated as £2.727m) which was an adverse movement of £0.112m from the deficit figure reported at Month 6, but now included the estimated net impact of Storm Babet
- A projected contingency reserve available balance as at 31st March 2024 of £3.664m (after the estimated impact of pay awards and taking account of previously approved allocations)

### **Housing Revenue Account**

- Net in-year revenue expenditure was forecast to be (£0.100m) lower than budget which was a favourable movement of (£0.031m) from the figure reported at Month 6
- A projected closing balance as at 31st March, 2024 of £3.297m

The Corporate Finance Manager explained that the economic outlook remained challenging due to inflation levels remaining high. The impacts of that, together with continued increases in service demand was becoming increasingly hard to deal with as the Councils funding failed to keep up with the scale of those pressures.

### **RESOLVED:**

- (a) That the report and the estimated financial impact on the 2023/24 budget be noted; and
- (b) That the transfer of a £0.500m Earmarked Reserve balance relating to Council Tax Income to the Contingency Reserve be approved.

## **93. TREASURY MANAGEMENT MID-YEAR REVIEW 2023/24**

Councillor Johnson introduced the report which presented the draft Treasury Management Mid-Year Report 2023/24.

As required by the Council's Financial Procedure Rules, the report was reviewed by the Governance and Audit Committee on 22nd November 2023 where officers responded to questions to the satisfaction of the Committee and there were no specific issues to bring to the attention of Cabinet.

It was recommended that the report be presented to County Council on 23<sup>rd</sup> January 2024 for final approval.

**RESOLVED:**

That the draft Treasury Management Mid-Year Report 2023/24 be recommended to County Council on 23<sup>rd</sup> January for final approval.

**94. BUSINESS RATES WRITE OFFS**

The Chief Officer (Governance) introduced the report and explained that bad debts above £25,000 required Cabinet to approve recommendations to write off those debts.

Two Business Rates debts, totalling £118,266.44, were deemed to be irrecoverable and the writing off the debts was now a necessary step. The debts related to:

- PPA Engineering Group Ltd £92,489.86
- Gibbs (Steel Fabricators) Ltd £25,776.58

**RESOLVED:**

That the write off of the business rate debts, amounting to £92,489 for PPA Engineering Group Ltd and £25,776 for Gibbs (Steel Fabricators) Ltd. be approved.

**95. SHELTERED HOUSING REVIEW**

Councillor Bibby introduced the report which provided an update on the Council's sheltered housing review, the proposed methodology and scoring matrix and the communication and engagement plan.

The Council's Housing Revenue Account (HRA) housing stock consisted of circa 7,300 properties with approximately 2,500 of those being classed as sheltered stock. With future standards increasing in terms of the Welsh Housing Quality Standards (WHQS), Welsh Government's ambitions with regards to decarbonisation, the need to ensure sheltered properties continued to meet the contract holders needs and the costs associated with investment and future maintenance, the Council were now required to ensure that any future expenditure was allocated appropriately. The options for those sheltered assets deemed to require significant investment to comply with current and future standards or were no longer meeting the needs of contract holders, were redesignation to general needs, refurbishment or demolition.

The review would adopt a holistic approach to the sustainability of the sheltered housing stock and reviewed each scheme from an asset management perspective to identify the current and future investment needs of each scheme, WHQS works and de-carbonisation and compliance considerations.

That information would be aligned to housing management intelligence and insight which would review and assess demand / turnover and desirability to

determine the sustainability of each scheme. Each scheme would be assessed against a sustainability matrix with four possible recommendations, each of which were outlined in the report.

It was important for the Council to ensure that its offer to current, and prospective, sheltered housing contract holders was attractive, competitive and meets current expectations and aspirations. It had been several years since the Council last reviewed its offer to sheltered housing contract holders and it was timely that the offer was updated.

The Chief Officer (Housing and Communities) said that following a report to Community and Housing Overview and Scrutiny Committee in March 2023, it was requested that a Sheltered Housing Review Task and Finish Group be established. That group had met on three occasions to consider the Terms of Reference, the Scoring Matrix and the Communications and Engagement Plan. That Scoring Matrix and Communications and Engagement Plan were outlined in the report which had also been considered and supported at Community and Housing Overview and Scrutiny Committee the previous week.

**RESOLVED:**

- (a) That the methodology proposed to assess the Council's sheltered assets be supported;
- (b) That the communication and engagement plan proposed to assess the Council's sheltered assets be supported; and
- (c) That the future assessment work to sheltered housing assets and progress to an options appraisal stage if investment concerns are highlighted through its in-depth review be supported.

**96. PUBLIC SERVICES OMBUDSMAN FOR WALES ANNUAL LETTER 2022-23 AND COMPLAINTS MADE AGAINST FLINTSHIRE COUNTY COUNCIL DURING THE FIRST HALF OF 2023-24**

The Chief Officer (Governance) introduced the report, the purpose of which was to share the Public Services Ombudsman for Wales Annual Letter 2022-23 for Flintshire County Council.

The Ombudsman's Annual Letter provided an overview of the annual performance of the Council in relation to complaints received between 1 April 2022 – 31 March 2023. The report also provided an overview of complaints received by each portfolio of the Council between 1 April 2023 – 30 September 2023.

The Customer Contact Manager explained that the number of complaints against local authorities across Wales reduced by 11% in 2022-23 compared to the previous year and the Ombudsman intervened with 13% of complaints, a reduction from 18% the year before.

Appended to the report was a link to the Annual Letter detailing Flintshire's performance and comparative data. The paragraphs in the report provided a summary of performance and additional context in response to the findings.

Matthew Harris, Head of the Complaints Standards Authority at the Ombudsman's office had no particular comments to make and referred to the Council being selected to be part of the Ombudsman's second wider Own Initiative Investigation looking into the administration of carer needs assessments. Details of what the investigation would consider were outlined in the report.

In response to a question from Councillor Bithell, the Customer Contact Manager said she would provide clarity on the details in the appendix outside of the meeting.

**RESOLVED:**

- (a) That the annual performance of the Council in respect of complaints made to the Public Services Ombudsman for Wales during 2022-23 be noted;
- (b) That the half year performance of the Council (2023-24) in respect of complaints made against services in line with the concerns and complaints procedure; and
- (c) That the priorities outlined in paragraph 1.24 be supported.

**97. INTRODUCING A CORPORATE FACEBOOK PAGE**

The Chief Officer (Governance) introduced the report and explained that having a social media presence via a corporate Facebook account would support Flintshire's ambitious Digital Strategy and the achievement of other key strategic plans by way of communicating and engaging with customers across Flintshire.

The Customer Service & Communications Team would launch and manage separate English and Welsh corporate Facebook accounts, posting simultaneously, to use for emergency communications, sharing key messages, good news stories, as well as consultation and engagement activities from across the organisation.

In response to a comment from Councillor Bithell, the Chief Officer explained that the Council would be able to remove any posts that were not relevant or, for example, were abusive.

**RESOLVED:**

- (a) That the introduction of a corporate Facebook account to help achieve priorities outlined in the Council Plan and Digital Strategy be supported;
- (b) That Cabinet champion the introduction of a corporate Facebook account and use the platform to share messages with customers.

**98. EXERCISE OF DELEGATED POWERS**

None.

**99. MEMBERS OF THE PRESS AND PUBLIC IN ATTENDANCE**

There were no members of the public in attendance.

(The meeting commenced at 10.00 a.m. and ended at 11.00 a.m.)

.....

**Chair**

Mae'r dudalen hon yn wag yn bwrpasol



# Eitem ar gyfer y Rhaglen 4



## CABINET

<b>Date of Meeting</b>	Tuesday 16 <sup>th</sup> January 2024
<b>Report Subject</b>	Medium Term Financial Strategy and Budget 2024/25 – Welsh Local Government Provisional Settlement
<b>Cabinet Member</b>	Cabinet Member for Finance, Inclusion, Resilient Communities including Social Value and Procurement for Finance, Inclusion, Resilient Communities including Social Value & Procurement
<b>Report Author</b>	Corporate Finance Manager and Chief Executive
<b>Type of Report</b>	Strategic

### EXECUTIVE SUMMARY

In December, Cabinet and Corporate Resources Overview and Scrutiny Committee received an update to the additional budget requirement for the 2024/25 financial year, which at that stage stood at £33.187m. The report identified potential funding solutions of £22.097m leaving an amount remaining at that time of £11.090m.

The purpose of this report is to provide an update on the key headlines and financial impacts of the Welsh Local Government Provisional settlement and to update on the work being undertaken on the range of budget solutions available to the Council to set a legal and balanced budget in February.

The Welsh Local Government Provisional Settlement was announced on 20 December 2023 as planned with responses to the consultation on the settlement invited by the deadline of 2 February 2024. A summary of the key headlines are set out in the report and have the effect of increasing the 'budget gap' to £12.946m.

The Provisional Welsh Local Government Settlement for Flintshire is extremely disappointing and presents an increased challenge to an already very difficult financial position.

Detailed final budget proposals now need to be prepared for member consideration and scrutiny and specific proposals will be considered by relevant Overview and Scrutiny Committees from February.

Arrangements are also being made to provide an opportunity for members to consider the overall budget proposals in advance of the Overview and Scrutiny meetings.

## RECOMMENDATIONS

1	That Cabinet notes the financial implications of the Welsh Provisional Local Government Settlement and the remaining work which needs to be completed prior to agreeing a set of recommendations for Council to set a legal and balanced budget on 20 February (which will be subject to prior consideration and comment by Overview and Scrutiny Committees).
---	--

## REPORT DETAILS

<b>1.00</b>	<b>EXPLAINING THE COUNCIL FUND REVENUE BUDGET 2024/25</b>
1.01	In July, Cabinet and Corporate Resources Overview and Scrutiny Committee were advised of an additional budget requirement for the 2024/25 financial year of £32.222m. This was revised upwards to £32.386m in September and the cost pressures and cost reductions options to date were referred to relevant Overview and Scrutiny Committees in October. Feedback from all sessions was reported back to Corporate Resources Overview and Scrutiny Committee on 16 November.
1.02	In December, Cabinet and Corporate Resources Overview and Scrutiny Committee received a further update to the additional budget requirement for the 2024/25 financial year, which at that stage stood at £33.187m. The report identified potential funding solutions of £22.097m leaving an amount remaining at that time of £11.090m.
1.03	The purpose of this report is to provide an update on the key headlines and financial impacts of the Welsh Local Government Provisional Settlement and to update on the work being undertaken on the range of budget solutions available to the Council to set a legal and balanced budget in February.

<b>2.00</b>	<b>THE WELSH LOCAL GOVERNMENT PROVISIONAL SETTLEMENT</b>
2.01	The Welsh Local Government Provisional Settlement was announced on 20 December as planned with responses to the consultation on the settlement invited by the deadline of 2 February. A summary of the key headlines is set out below.
2.02	<b>Standard Spending Assessment (SSA)</b>  The provisional Standard Spending Assessment (SSA) for 2024/25 is £361.297m which is an increase of 3.6% (£12.497m) on the SSA for 2023/24 of £348.800m.

2.03	<p><b>Aggregate External Finance (AEF)</b></p> <p>The provisional Aggregate External Finance (AEF) for 2024/25 is £257.555m which, when compared to the adjusted 2023/24 AEF figure of £251.959m represents an <i>increase</i> of 2.2% (£5.596m) (All Wales average is an <i>increase</i> of 3.1 % with Local Authority increases ranging from 2% to 4.7%).</p> <p>The percentage increase for the Council is the third lowest in Wales.</p> <p>The provisional AEF represents a cash uplift of £5.560m (2.2%) over the 2023/24 AEF of £251.995m.</p>
2.04	<p><b>Transfers In/Out of the Settlement</b></p> <p>There are no transfers into or out of the settlement for the Council.</p>
2.05	<p><b>Funding Per Capita</b></p> <p>The Aggregate External Finance allocation provides an amount of £1,658 per capita compared to the Welsh average of £1,817 which places Flintshire 20th out of the 22 Welsh Councils (also 20th in 2023/2024)</p>
2.06	<p><b>Additional Funding (Floor)</b></p> <p>Additional funding of £1.3m is included in the settlement to ensure that no authority will receive less than a 2% increase. Two authorities have benefitted from this.</p>
2.07	<p><b>Specific Grants</b></p> <p>Some details have been included for specific grants on an all-Wales basis which are being worked through in detail.</p> <p>However, an initial review of grants at an all-Wales level indicates that there will be a reduction in the Social Care Workforce Grant of around 22% (£45m to £35m) and a reduction in the Homelessness No One Left Out Approach Grant of 33% (£15m to £10m).</p> <p>The Sustainable Waste Management Grant is still to be confirmed.</p>
2.08	<p><b>Non-Domestic Rates (NDR) multiplier</b></p> <p>The provisional settlement refers to an increase in the Non-Domestic Rates (NDR) multiplier for 2024/25.</p> <p>The NDR multiplier has remained unchanged at the same level since 2020/21, but the provisional settlement signals that it will increase in 2024/25 by 5%.</p>

	<p>It had been anticipated that the multiplier would remain frozen at the current rate as it has been in England. This change will result in an increased cost of around £0.131m for Council Buildings.</p> <p>This is in addition to the additional cost of £0.131m arising from a reduction of transitional relief for ratepayers following the UK-wide revaluation exercise, which took effect on 1 April 2023.</p> <p>A second unexpected announcement was the reduction in Retail Rate Relief from 75% to 40%. This once again is a diversion from the scheme in England where the rate is to be maintained as a 75% discount.</p>
2.09	<p><b>Pay Awards</b></p> <p>The Ministers Statement makes it clear that Local Authority budget planning must accommodate the impact of all pay settlements for Teacher and Non-Teacher pay awards. There is no additionality for the recurring impact of the increased Teacher Pay Award (Sep 2022) which had previously been stated by Welsh Government (£1.152m).</p>
2.10	<p><b>Teacher Pensions</b></p> <p>Reference is made to the increase in employer teacher pension costs from April 2024. It is confirmed that the additional cost is expected to be funded by UK Government and that assurances are being sought by Welsh Government. This is in line with our current assumptions as the additional cost is not included within the additional budget requirement calculation (refer also to para 2.19).</p>
2.11	<p><b>Indicative Allocations for future years</b></p> <p>The Settlement does not refer to any indicative allocations for future years, unlike previously, where Welsh Government set out an indicative three-year settlement which assisted local authorities in their future budget planning.</p>
	<p><b>IMPACT OF THE SETTLEMENT ON THE BUDGET 2024/25</b></p>
2.12	<p>As set out earlier in the report an additional budget requirement of £33.187m was reported in December together with potential funding solutions of £22.097m – leaving an amount remaining at that stage of £11.090m</p> <p>However, the funding solutions assumed an uplift of £7.285m from Welsh Government AEF (based on an Indicative 3.1% adjusted for known data changes at the time).</p> <p>The AEF uplift confirmed in the settlement of £5.560m is £1.725m lower which has the effect of increasing the amount remaining to £12.815m (from £11.090m) – this further increases to £12.946m when taking into account the increase in NDR multiplier (estimated at £0.131m).</p> <p>Changes to specific funding streams such as Social Care Workforce Grant and Homelessness Grants may also negatively impact on the overall position and the details of these are being worked through.</p>
	<p><b>ONGOING RISKS TO THE ADDITIONAL BUDGET REQUIREMENT</b></p>

2.13	A number of ongoing risks have been reported previously which will potentially impact on the additional budget requirement and further detail is set out below:
2.14	<p><b>Funding for Pay Awards</b></p> <p>It is now clear that the allocation provided for 2024/25 will need to cover in full the impacts of all pay awards (Teacher and Non-Teacher).</p> <p>Predicting pay awards that are nationally agreed in the current economic climate is particularly challenging. However, as was the case this year any agreed pay award in excess of the Council's budgeted provision will result in a reduction of our limited reserves in-year and also impact on the following year with the requirement to include such increases in our budget on a recurring basis.</p> <p>The current assumed increase, for planning purposes, of 5% will be kept under review prior to final budget setting in February.</p>
2.15	<p><b>Homelessness</b></p> <p>The Council is continuing to experience high and increasing demand for temporary accommodation in order to meet its statutory obligations to accommodate families and persons that present themselves as homeless which is expected to continue.</p> <p>The latest budget monitoring position is forecasting a net overspend of £2.7m and the indication of the reduction in the Homelessness No One Left Out Approach Grant of 33% (£15m to £10m), will further impact on the pressure the Council is likely to face in 2024/25.</p> <p>The impact of this together with the increasing demand for this service are currently being assessed and this remains a significant risk which will need to be considered as part of final budget setting.</p>
2.16	<p><b>Out of County Placements</b></p> <p>The position on Out of County placements remains an ongoing risk and the projected overspend in the current financial year is now £1.526m. An amount of £0.500m is included in the current forecast which will need to continue to be kept under close review and risk assessed as part of final budget setting.</p>
2.17	<p><b>Social Care</b></p> <p>Risks remain within the service such as on-going recruitment and retention challenges, new statutory responsibilities, the impact of inflationary increases as well as match funding for projects such as the Regional Integration Fund (RIF).</p> <p>The reduction in the Social Care Workforce Grant is very concerning as it supports the delivery of front-line services and the risk remains around other grants, the detail of which is being worked through.</p>

2.18	<p><b>Streetscene and Transportation</b></p> <p>The review of the Waste Strategy remains a risk due to the potential impact on future costs of the service in relation to the ongoing risk of potential infraction fines for failing to achieve Welsh Governments statutory recycling targets in 2022-2023 (estimated to be in the region of £470k).</p> <p>The risk that the Sustainable Waste Management Grant (SWMG) may cease or reduce is still a concern. The SWMG is a revenue grant of £0.742m provided by Welsh Government to support the provision of re-use and recycling services, as well as preventing waste. The Provisional Settlement gives no indication of the level of this grant for 2024/25 with it to be confirmed at a later date by Welsh Government.</p> <p>The funding arrangements for the Bus Emergency Scheme (BES) and the Bus Transition Fund (BTF) is also still unknown beyond March 2024 so will need to be kept under close review. These have previously been funded by Welsh Government.</p>
2.19	<p><b>Education and Youth</b></p> <p>Confirmation has been received that employer teacher pension contributions will increase by 5% from April 2024. A high-level estimate is that this will lead to a pressure of £3m for schools. The provisional settlement states that this is expected to be met by UK Government and that assurances are being sought by Welsh Government</p> <p>Increases in demand and complexity for Additional Learning Needs, Specialist Provision and Education Other Than at School (EOTAS) is currently being funded by additional Welsh Government grant. There are a number of risks relating to the continuation of grant funding into 2024/25 which will need to be kept under review and this will be considered as we work through the detail of the provisional settlement.</p> <p>Further work is being undertaken on demography and the impact of any changes on revenue costs due to the school modernisation programme.</p>
	<b>BUDGET SOLUTIONS</b>
2.20	The options available to the Council to meet its significant additional budget requirement is summarised in the following paragraphs.
2.21	<p><b>Government Funding - Aggregate External Finance (AEF)</b></p> <p>The Provisional Settlement has advised of an additional £5.560m and this is not expected to change significantly at the Final Settlement stage.</p>
2.22	<b>Efficiencies / Cost Reductions – Portfolios</b>

	<p>As reported in the December report all portfolios have been revisiting their cost base with a view to achieving further budget reductions and the outcome of this work is currently being finalised and risk assessed in detail.</p> <p>Details of the potential cost reductions will be shared as soon as this work is completed and will need to be considered by the relevant scrutiny committees in early February in advance of the Cabinet and Council meetings on 20 February.</p>
2.23	<p><b>Council Tax</b></p> <p>The scale of the additional budget requirement due to increases in service demand and persistent higher inflation means that it is inevitable that a further increase will need to be considered as part of final budget setting. This is in line with the position in many councils across Wales and is reflective of fiscal analysis presented at a recent presentation to the Council by the Welsh Local Government Association.</p> <p>Each further increase of 1% in Council Tax (net of the impact on the Council Tax Reduction Scheme) would provide an additional £0.882m towards the gap.</p>
2.24	<p><b>Schools Budget</b></p> <p>The delegated schools budget has been protected in recent years.</p> <p>However, as the Council's largest budget it is inevitable that consideration will need to be given to a reduction in the 2024/25 financial year.</p> <p>School budgets benefitted from a net uplift of £5.761m in 2023/24 after taking into account increases for pay, energy, free school meals, demography, offset by a 3% reduction and agreed savings on National Insurance and Pension Contributions.</p> <p>The current additional budget requirement for 2024/25 includes total cost pressures of £9.049m for school budgets for pay awards and other identified pressures.</p> <p>Each further 1% reduction on the school's budget would equate to £1.091m off the cumulative cost pressures currently included.</p>
2.25	<p><b>Social Care – Commissioning Costs</b></p> <p>Social Care budgets have also been protected in recent years and commissioning costs increased above average across North Wales for the current financial year.</p> <p>An increase at similar levels is not sustainable due to the Council only receiving an increase of 2.2% in its annual Welsh Government settlement.</p> <p>Therefore, the Council will need to provide a much more prudent uplift in 2024/25 which will be subject to negotiation with care providers over the coming weeks.</p>

2.26	<p><b>Strategic Programme of Transformation</b></p> <p>Work has commenced on planning and delivering a strategic programme of service transformation to ensure that the Council is developing cost reductions over the next five years to protect its ongoing future financial position and ensure it is further prepared for inevitable and potentially more significant budget reductions from 2025/26 onwards.</p> <p>Due to the scale and complexity of this work, the intention is for these workstreams to provide financial support and a degree of stability from 2025/26 onwards so will not assist with the immediate budget challenge for 2024/25.</p> <p>As noted earlier the provisional settlement does not give an indicative settlement figure for 2025/26 onwards but indications from the Wales Institute of FISCAL studies are that future settlement will be less than 1% or even potentially cash flat - therefore it is important that work on this programme is identified as a high priority for the Council in 2024/25.</p>								
2.27	<p><b>Summary and Conclusions</b></p> <p>The provisional local government settlement for Flintshire is extremely disappointing and presents an increased challenge to an already very difficult financial position.</p> <p>Representations will continue to be made for a better settlement alongside all Welsh Councils through the Welsh Local Government Association (WLGA), and a formal response to the provisional settlement will be submitted in advance of the deadline by the Council.</p> <p>At this stage the amount remaining to be found to reach a legal and balanced budget has increased to around £13m with a number of risks and impacts of specific grant reductions remaining which could increase this figure still further.</p> <p>Detailed final budget proposals now need to be prepared for member consideration and scrutiny, and specific proposals will be considered by relevant Overview and Scrutiny Committees from February.</p> <p>Arrangements are also being made to provide an opportunity for members to consider the overall budget proposals in advance of the Overview and Scrutiny meetings.</p>								
2.28	<p><b>Budget Timeline</b></p> <table border="1" data-bbox="320 1776 1385 1928"> <thead> <tr> <th data-bbox="320 1776 703 1809">Date</th> <th data-bbox="703 1776 1385 1809">Event</th> </tr> </thead> <tbody> <tr> <td data-bbox="320 1809 703 1850">1 – 9 February</td> <td data-bbox="703 1809 1385 1850">Specific Overview and Scrutiny Meetings</td> </tr> <tr> <td data-bbox="320 1850 703 1890">20 February 2024</td> <td data-bbox="703 1850 1385 1890">Cabinet and Council – Budget Setting</td> </tr> <tr> <td data-bbox="320 1890 703 1928">March 2024</td> <td data-bbox="703 1890 1385 1928">Welsh Government Final Budget/Settlement</td> </tr> </tbody> </table>	Date	Event	1 – 9 February	Specific Overview and Scrutiny Meetings	20 February 2024	Cabinet and Council – Budget Setting	March 2024	Welsh Government Final Budget/Settlement
Date	Event								
1 – 9 February	Specific Overview and Scrutiny Meetings								
20 February 2024	Cabinet and Council – Budget Setting								
March 2024	Welsh Government Final Budget/Settlement								

**3.00 RESOURCE IMPLICATIONS**



3.01	<p><b>Revenue:</b> the revenue implications for the 2024/25 budget are set out in the report.</p> <p><b>Capital:</b> the borrowing needs for the capital programme are built into the revenue estimates for 2024/25.</p>

<b>4.00</b>	<b>IMPACT ASSESSMENT AND RISK MANAGEMENT</b>
-------------	--

4.01	<b>Ways of Working (Sustainable Development) Principles Impact</b>	
	Long-term	Negative – the absence of longer-term funding settlements from Welsh Government means that sustainable support for service delivery is challenging for the longer term. Sustainable funding from Welsh Government that provides additional funding for Indexation, Service demands and new legislation will provide a positive and sustainable position for the Council in the longer term.
	Prevention	As above
	Integration	Neutral Impact
	Collaboration	Services continue to explore opportunities for collaboration with other services and external partners to support positive impacts.
	Involvement	Communication with Members, residents and other stakeholders throughout the budget process.
	<b>Well-Being Goals Impact</b>	
	Prosperous Wales	Longer term funding settlements from Welsh Government that provide additional funding for indexation, service demands and new legislation will aid sustainability and support a strong economy that encourages business investment in the region. The opposite will be true if settlements are inadequate.
	Resilient Wales	Continuation of services to support communities and social cohesion will have a positive impact. The opposite will be true if settlements are inadequate.
	Healthier Wales	An appropriate level of funding will ensure that communities are supported and will have a positive impact. The opposite will be true if settlements are inadequate.

	More equal Wales	A positive impact with greater parity of funding from Welsh Government for all Welsh Local Authorities. The opposite will be true if settlements are inadequate.
	Cohesive Wales	Appropriate level of funding will support services working alongside partners. The opposite will be true if settlements are inadequate.
	Vibrant Wales	As Healthier and Cohesive Wales above
	Globally responsible Wales	Neutral impact.

<b>5.00</b>	<b>CONSULTATIONS REQUIRED/CARRIED OUT</b>
5.01	Chief Officer Team, the Finance Team, Cabinet Members, Group Leaders and Scrutiny Committees. Workforce conferences have been held for employees.

<b>6.00</b>	<b>APPENDICES</b>
6.01	None

<b>7.00</b>	<b>LIST OF ACCESSIBLE BACKGROUND DOCUMENTS</b>
7.01	Cabinet Report 18 July 2023 Cabinet Report 19 September 2023 Scrutiny Reports and Presentations October 2023 Cabinet Report 19 December 2023

<b>8.00</b>	<b>CONTACT OFFICER DETAILS</b>
8.01	<b>Contact Officer:</b> Gary Ferguson, Corporate Finance Manager <b>Telephone:</b> 01352 702271 <b>E-mail:</b> <a href="mailto:gary.ferguson@flintshire.gov.uk">gary.ferguson@flintshire.gov.uk</a>

<b>9.00</b>	<b>GLOSSARY OF TERMS</b>
9.01	<b>Medium Term Financial Strategy (MTFS):</b> a written strategy which gives a forecast of the financial resources which will be available to a Council for a given period, and sets out plans for how best to deploy those resources to meet its priorities, duties and obligations.

**Revenue:** a term used to describe the day to day costs of running Council services and income deriving from those services. It also includes charges for the repayment of debt, including interest, and may include direct financing of capital expenditure.

**Budget:** a statement expressing the Council's policies and service levels in financial terms for a particular financial year. In its broadest sense it includes both the revenue budget and capital programme and any authorised amendments to them.

**Revenue Support Grant:** the annual amount of money the Council receives from Welsh Government to fund what it does alongside the Council Tax and other income the Council raises locally. Councils can decide how to use this grant across services although their freedom to allocate according to local choice can be limited by guidelines set by Government.

**Specific Grants:** An award of funding from a grant provider (e.g. Welsh Government) which must be used for a pre-defined purpose.

**Welsh Local Government Association:** the representative body for unitary councils, fire and rescue authorities and national parks authorities in Wales.

**Financial Year:** the period of 12 months commencing on 1 April.

**Local Government Funding Formula:** The system through which the annual funding needs of each council is assessed at a national level and under which each council's Aggregate External Finance (AEF) is set. The revenue support grant is distributed according to that formula.

**Standard Spending Assessment (SSA) -** The SSA is the amount of revenue expenditure Welsh Government considers appropriate to ensure that each local authority can provide a standard level of service. The SSA takes account of factors such as population, sparsity and deprivation.

**Aggregate External Finance (AEF):** The support for local revenue spending from the Welsh Government and is made up of formula grant including the revenue support grant and the distributable part of non-domestic rates.

**Provisional Local Government Settlement:** The Provisional Settlement is the draft budget for local government published by the Welsh Government for consultation. The Final Local Government Settlement is set following the consultation.

**Funding Floor:** a guaranteed level of funding for councils who come under the all-Wales average change in the annual Settlement. A floor has been a feature of the Settlement for many years.

Mae'r dudalen hon yn wag yn bwrpasol

# Eitem ar gyfer y Rhaglen 5



## CABINET

<b>Date of Meeting</b>	Tuesday, 16 <sup>th</sup> January 2024
<b>Report Subject</b>	Council Plan 2023/24 Mid-Year Performance Monitoring Report
<b>Cabinet Member</b>	Cabinet Member for Governance and Corporate Services including Health and Safety and Human Resources
<b>Report Author</b>	Chief Executive
<b>Type of Report</b>	Strategic

## EXECUTIVE SUMMARY

The Council Plan 2023/28 was adopted by the Council in June 2023. This report presents a summary of performance of progress against the Council Plan priorities identified for 2023/24 at the mid-year position.

This report is an exception-based report and concentrates on those areas of performance which are not currently achieving their target at the mid-year position.

This report contains progress against the actions and measures that are monitored and updated on a quarterly basis. Progress against the annual measures within the Council Plan will be captured within the End of Year Performance Report.

## RECOMMENDATIONS

1.	To endorse and support the levels of progress and confidence in the achievement of priorities as detailed within the Council Plan 2023/28 for delivery within 2023/24.
2.	To endorse and support overall performance against Council Plan 2023/24 performance indicators/measures.
3.	To be assured by explanations given for those areas of underperformance.

## REPORT DETAILS

1.00	<b>EXPLAINING THE COUNCIL PLAN 2023/24 PERFORMANCE AT MID-YEAR</b>																																							
1.01	The Council Plan Mid-Year Performance Report provides an explanation of the progress made towards the delivery of the priorities set out in the 2023/28 Council Plan for delivery within 2023/24. The narrative is supported by information on performance indicators and/or milestones.																																							
1.02	This report is an exception-based report and concentrates on those areas of performance which are not currently achieving their target.																																							
1.03	<p><b>Monitoring our Performance</b></p> <p>Each of the sub-priorities under each priority within the Plan have high level activities which are monitored over time. 'Progress' shows action against scheduled activity and is categorised as:</p> <ul style="list-style-type: none"> <li>• <b>RED:</b> Limited Progress, delay in scheduled activity and not on track</li> <li>• <b>AMBER:</b> Satisfactory Progress, some delay in scheduled activity, but broadly on track</li> <li>• <b>GREEN:</b> Good Progress, activities completed on schedule and on track</li> </ul>																																							
1.04	<p><b>Progress against Council Plan activity (Actions)</b></p> <p>In summary, our overall progress against the activities identified in the Council Plan for 2023/24 is:</p> <ul style="list-style-type: none"> <li>• Good (green) progress was achieved in 67% (99) of activities.</li> <li>• Satisfactory (amber) progress was achieved in 30% (44) of activities.</li> <li>• Limited (red) progress was made in 3% (4) of activities.</li> </ul> <table border="1" data-bbox="336 1395 1409 1816"> <thead> <tr> <th rowspan="2">PRIORITY</th> <th colspan="3">ACTIONS</th> </tr> <tr> <th>GREEN</th> <th>AMBER</th> <th>RED</th> </tr> </thead> <tbody> <tr> <td>Poverty</td> <td>14</td> <td>3</td> <td>0</td> </tr> <tr> <td>Affordable and Accessible Housing</td> <td>11</td> <td>10</td> <td>0</td> </tr> <tr> <td>Green Society and Environment</td> <td>16</td> <td>11</td> <td>2</td> </tr> <tr> <td>Economy</td> <td>17</td> <td>5</td> <td>1</td> </tr> <tr> <td>Personal and Community Well-being</td> <td>18</td> <td>2</td> <td>0</td> </tr> <tr> <td>Education and Skills</td> <td>14</td> <td>6</td> <td>0</td> </tr> <tr> <td>A Well Managed Council</td> <td>9</td> <td>7</td> <td>1</td> </tr> <tr> <td><b>Overall Progress</b></td> <td><b>99 (67%)</b></td> <td><b>44 (30%)</b></td> <td><b>4 (3%)</b></td> </tr> </tbody> </table>	PRIORITY	ACTIONS			GREEN	AMBER	RED	Poverty	14	3	0	Affordable and Accessible Housing	11	10	0	Green Society and Environment	16	11	2	Economy	17	5	1	Personal and Community Well-being	18	2	0	Education and Skills	14	6	0	A Well Managed Council	9	7	1	<b>Overall Progress</b>	<b>99 (67%)</b>	<b>44 (30%)</b>	<b>4 (3%)</b>
PRIORITY	ACTIONS																																							
	GREEN	AMBER	RED																																					
Poverty	14	3	0																																					
Affordable and Accessible Housing	11	10	0																																					
Green Society and Environment	16	11	2																																					
Economy	17	5	1																																					
Personal and Community Well-being	18	2	0																																					
Education and Skills	14	6	0																																					
A Well Managed Council	9	7	1																																					
<b>Overall Progress</b>	<b>99 (67%)</b>	<b>44 (30%)</b>	<b>4 (3%)</b>																																					
1.05	The activities which show a <b>Red RAG</b> status and are off track at mid-year are listed below:																																							

	<p><b>PRIORITY: GREEN SOCIETY AND ENVIRONMENT</b>  <b><u>Sub Priority: Active and Sustainable Travel Options</u></b>  Declassification of hazardous routes across the county where appropriate through the implementation of engineering initiatives  A list of the Counties' Hazardous Routes has been compiled. Following completion of infrastructure schemes, routes will be reviewed in accordance with the Learner Travel Guidance to ascertain compliance and will request political approval.</p> <p><b><u>Sub Priority: Circular Economy</u></b>  Develop a Recycling Waste Transfer Station for the deposit and processing of recyclable materials.  This relates to the project referred to as 'Standard Yard', where funding was secured to develop and build a dedicated transfer station for the authority. Due to inflationary changes to the economy, the available grant funding no longer covers the cost of the project. The long-term feasibility of the project is currently being reviewed by Streetscene with the support of local partnerships.</p> <p><b>PRIORITY: ECONOMY</b>  <b><u>Sub Priority: Local Development Plan (LDP) Targets</u></b>  Reference the LDP growth strategy in early work on a North Wales Strategic Development Plan (SDP)  Work is commencing on scoping out the preparation of a Strategic Development Plan (SDP) for North Wales. The growth strategy of the Local Development Plan will provide up to date planning context for the SDP.</p> <p><b>PRIORITY: A WELL MANAGED COUNCIL</b>  <b><u>Sub Priority: Flintshire Assets</u></b>  Review of Industrial Estate Strategy (Area by Area)  Reviews have taken place in Castle Park and Greenfield as part of the Levelling Up Fund (LUF) bid. Options are currently being reviewed.</p>
1.06	<p><b>Performance against the Council Plan Performance Indicators (Measures)</b></p> <p>Analysis of performance against the performance indicators is undertaken using the RAG status. This is defined as:</p> <ul style="list-style-type: none"> <li>• <b>RED</b> - Under-performance against target.</li> <li>• <b>AMBER</b> - Where improvement may have been made but performance has missed the target.</li> <li>• <b>GREEN</b> - Positive performance against target.</li> </ul>

1.07 Analysis of the mid-year performance against the targets set for 2023/24 shows:

- 32 (46%) measures have a green RAG status
- 14 (20%) measures have an amber RAG status
- 24 (34%) measures have a red RAG status

PRIORITY	MEASURES		
	GREEN	AMBER	RED
Poverty	6	1	3
Affordable and Accessible Housing	8	3	12
Green Society and Environment	4	2	5
Economy	3	1	1
Personal and Community Well-being	11	2	0
Education and Skills	0	0	0
A Well Managed Council	0	5	3
<b>Overall Progress</b>	<b>32 (46%)</b>	<b>14 (20%)</b>	<b>24 (34%)</b>

1.08 The performance indicators/measures which show a **Red RAG** status for performance against the target set are listed below:

**PRIORITY: POVERTY**

**Sub Priority: Income Poverty**

**CHC003M - Total spend of Discretionary Housing Payments (%)**

(Actual 87% – Target 50%)

Discretionary Housing Payments (DHP) expenditure is exceeding target values due to the increase in DHP applications and support required. This has been the result of the financial impacts amongst households during the cost-of-living crisis. Currently we receive additional funding via Homeless Prevention Funding and will consider how we can utilise a Discretionary Support Scheme to support households in a broader way.

**Sub Priority: Food Poverty**

**CHC006M - Number of residents supported by the “Hospital to Home” meals service.**

(Actual 0 – Target 74)

Changes have been made to the 'Hospital to Home' service and a three-month pilot is due to commence in November 2023. Therefore, there is no data available for mid-year.

**Sub Priority: Digital Poverty**

**CGV006M - Number of Digital Surgeries held at Connects Centres**

(Actual 0 – Target 3)

Recruitment of Digital Volunteers from across the workforce is underway following Trade Union approval of the Volunteering Policy.



**PRIORITY: AFFORDABLE AND ACCESSIBLE HOUSING**

**Sub Priority: Housing Support and Homeless Prevention**

**CHC007M - Number of presentations to the homeless service**

(Actual 907 – Target 700)

Presentations to the homeless service continue to be significant (490 presentations in quarter 1 and 417 presentations in quarter 2). Of those households who identified as at risk of homelessness or homeless and approached the Council for support a total of 644 progressed to a Homeless Assessment (Section 62 Housing (Wales) Act 2014). Those who did not progress were either offered advice and assistance, as they were not at risk of homelessness, ineligible, or further contact was not made when Officers were seeking to undertake the Homeless Assessment.

**CHC008M - Percentage of successful relief outcomes for homelessness under Housing (Wales) Act 2014**

(Actual 64.44% – Target 70%)

Data still to be validated as part of Welsh Government WHO12 National Reporting. Whilst performance is below target this is still positive performance in light of the current housing conditions when considering the few opportunities there are to prevent homelessness in many cases.

**CHC010M - Number of households accommodated by the Council under Housing (Wales) Act 2014 homeless duties.**

(Actual 218 – Target 150)

Demand for homeless accommodation remains high and significant barriers to moving people on through both private rented sector due to limited availability and high rent costs, along with the limited availability of social housing. The significant lack of 1 bed social housing for people under the age of 55 remains the greatest barrier to helping people exit homelessness and this group accounts for approx. 80% of the homeless cohort. The number of households in homeless accommodation increased significantly in quarter 1 but have remained relatively stable in quarter 2 with a slight reduction in Month 6.

**CHC011M - Average length of stay (days) for those households in interim homeless accommodation under Housing (Wales) Act 2014**

(Actual 193 – Target 130)

Pressures on homeless accommodation continue to be significant with high numbers of households assisted with accommodation due to homelessness. With significant barriers to move on from homeless accommodation due to lack of available social housing of the right types in the right places and a difficult private rented sector, it is not a surprise that people are remaining in homeless accommodation longer. The homeless cohort average stay is 193 but this can be broken down further by household type. Singles and couples without children are reported as 200 days average. Families are reported as 152 days average.

**Sub Priority: Housing Needs and Housing Options**

**CHC015M - Number of applicants rehoused via SARTH by All Housing Partners**

(Actual 257 – Target 310)

There have been a total of 117 applicants rehoused in quarter one and 140 for quarter two, which gives a total of 257 applicants rehoused at the mid-year

point. The breakdown is as follows; 24 Clwyd and Alyn, 212 Flintshire County Council and 21 Wales and West to date.

**Sub Priority: Social Housing**

**CHC018M - Number of Council Homes under construction**

(Actual 3 – Target 14)

Schemes have slipped in the program and are currently at the Welsh Government Technical Approval stage before the Planning applications can be made with a view to being on site in the first quarter of 2024/25.

**CHC022M - Number of Residential Social Landlords (RSL's) homes under construction**

(Actual 21 – Target 96)

There has been slippage on two large schemes (156 units) at Northern Gateway and Mynydd Isa where both main contractors have gone into liquidation requiring the engagement of new Contractors. There has also been a delay while waiting on a decision from Welsh Government regarding additional funding on some of the schemes. We anticipate that these schemes will be on site under construction in the fourth quarter of 2023/24.

**CHC023M - Number of Residential Social Landlord (RSL's) homes completed.**

(Actual 8 – Target 17)

Eight properties have been completed so far this year and the remainder are expected to be completed by the end of this financial year.

**CHC039M - Total number of Medium Disabled Adaptations completed.**

(Actual 39 – Target 50)

We are reliant on Occupational Therapist referrals for any adaptations, we do not have any control over the amount we receive, neither are they in control of the number of requests they receive from members of the public. It is therefore difficult to set a target, so we use the previous year's figures to set the target.

**CHC043M - Total number of Large Disabled Adaptations completed.**

(Actual 3 – Target 4)

Similar to medium adaptations it is difficult to set a target apart from looking at previous years. Large adaptations are even more difficult to ascertain when they will complete as some are slower than others due to their complexity and designs. Some need planning, others don't, and some contractors can start quicker than others. Currently, we have 2 large cases with works ongoing, 2 cases with a contractor waiting to start, 2 cases out for tender and 6 cases currently being worked on by the surveyor.

**CHC044M - Average number of days to complete a Large Disabled adaptation.**

(Actual 693 – Target 456)

Positively a number of large legacy cases were completed in the first quarter of this financial year, however, in doing so this had had an adverse effect on our target. However, as all legacy cases have now been completed the average number of days to complete large cases will start to reduce.

**Sub Priority: Private Rented Sector**

**CHC040M - Landlords engaged through Flintshire Landlord Forum**

(Actual 25 – Target 40)

This is a new measure so this year will form the baseline data for future targets. The Landlord Forum aims to meet four times a year and last met in May 2023 with 25 landlords and or lettings agents attending. The focus of the Forum was on Financial Support for Landlords and Residents. A further Forum was planned for September 2023 but had to be cancelled but will be picked up in Quarter 3 and will focus on Resident Welfare and Complex Housing Needs.

**PRIORITY: GREEN SOCIETY AND ENVIRONMENT**

**Sub Priority: Net Zero Carbon Council**

**CPE020M - Number of contracts with carbon impact assessed.**

(Actual 0 – Target 5)

A joint Procurement Business Partner for Decarbonisation starts in September 2023 and will focus on developing and implementing the process for establishing supplier's actual carbon emissions as part of their contract.

**CPE021M - Percentage of schools accessing the support package.**

(Actual 0% – Target 5%)

Support package is now ready for piloting with schools during October 2023 - March 2024.

**CPE022M - Percentage of Town and Community Councils accessing the support package.**

(Actual 0% – Target 5%)

Offer to Town and Community Councils will be made during October 2023 - March 2024.

**Sub Priority: Circular Economy**

**CST017M - Reduce the tonnage of residual waste collected from residential properties.**

(Actual 0% – Target 5%)

The amount of residual waste collected from residential did not reduce in quarter one in comparison to the same period in the previous year.

**CST018M - Increase the tonnage of food waste collected from residential properties.**

(Actual -4% – Target 7%)

The amount of food waste collected for quarters one and two has decreased by 81 tonnes in comparison to the same period in the previous year resulting in the amount of food waste collected decreasing by 4%.

**PRIORITY: A WELL MANAGED COUNCIL**

**Sub Priority: People**

**CHR004M - Percentage of employees who have completed all of the mandatory modules.**

(Actual 39.40% – Target 100%)

The overall completion rate at mid-year is 39.40%. Managers receive monthly progress reports for their teams to ensure that the training has been completed. Workshops and group sessions are coordinated to accommodate

	<p>work groups who do not have I.T access, such as Streetscene Operatives and school-based employees.</p> <p><b><u>Sub Priority: Anti-Racist and Anti-Discriminatory Council</u></b>  <b>CPA001M - Strategic Equality Action Plan in place and actions achieved.</b>          (Actual 40% – Target 50%)          Percentage refers to the development of the Strategic equality Plan (SEP) for 2024-28 and the implementation of actions. The target for 2023/24 was to develop and publish the SEP by the end of the financial year. Engagement and consultation has taken place with stakeholders to inform the draft Strategic Equality Plan. The draft Plan is now ready and will be going to Informal Cabinet for approval and wider consultation. Implementation of the actions won't start taking place until April 2024 onwards.</p> <p><b><u>Sub Priority: Digital</u></b>  <b>CGV008M - 80% of telephone calls to the corporate Contact Centre answered.</b>          (Actual 68% – Target 80%)          In the first half of 2023-24 the corporate Contact Centre were presented with 88,384 telephone calls, 68% were answered. The service deals with a wide range of telephone calls including two areas that generate the highest volume of customer contact - Streetscene (35,944) and Housing (34,272), Planning, Elections, Blue Badges and Switchboard. The best performing area is Streetscene with 73% of calls answered. Whilst falling short on its target, the corporate Contact Centre has faced significant staff challenges this year with several vacant posts and sickness which inevitably impact performance and how quickly telephone calls can be answered within the limited resources available.</p>
--	---

<b>2.00</b>	<b>RESOURCE IMPLICATIONS</b>
2.01	There are no specific resource implications for this report.

<b>3.00</b>	<b>IMPACT ASSESSMENT AND RISK MANAGEMENT</b>								
3.01	<p><b>Ways of Working (Sustainable Development) Principles Impact</b></p> <table border="1" style="width: 100%;"> <tr> <td style="width: 40%;">Long-term</td> <td rowspan="5">Throughout the Mid-Year Monitoring Report there are demonstrable actions and activities which relate to all the Sustainable Development Principles. Specific case studies will be included in the Annual Performance Report for 2023/24.</td> </tr> <tr> <td>Prevention</td> </tr> <tr> <td>Integration</td> </tr> <tr> <td>Collaboration</td> </tr> <tr> <td>Involvement</td> </tr> </table> <p><b>Well-being Goals Impact</b></p> <table border="1" style="width: 100%;"> <tr> <td style="width: 40%;">Prosperous Wales</td> <td>Throughout the Mid-Year Monitoring</td> </tr> </table>	Long-term	Throughout the Mid-Year Monitoring Report there are demonstrable actions and activities which relate to all the Sustainable Development Principles. Specific case studies will be included in the Annual Performance Report for 2023/24.	Prevention	Integration	Collaboration	Involvement	Prosperous Wales	Throughout the Mid-Year Monitoring
Long-term	Throughout the Mid-Year Monitoring Report there are demonstrable actions and activities which relate to all the Sustainable Development Principles. Specific case studies will be included in the Annual Performance Report for 2023/24.								
Prevention									
Integration									
Collaboration									
Involvement									
Prosperous Wales	Throughout the Mid-Year Monitoring								

Resilient Wales	Report there is evidence of alignment with the Well-being Goals. Specific strategic and policy reports include impact and risk assessments.
Healthier Wales	
More equal Wales	
Cohesive Wales	
Vibrant Wales	
Globally responsible Wales	
<p><b>Council's Well-being Objectives</b></p> <p>The Council undertook a review of its Well-being Objectives during the development of the Council Plan. The updated set of Well-being Objectives are a more focused set of seven. The Well-being Objectives identified have associated priorities for which they resonate. See the full list below.</p>	
<b>Priority</b>	<b>Well-being Objective</b>
Poverty	Protecting our communities and people from poverty by supporting them to meet their basic needs and to be resilient
Affordable and Accessible Housing	Housing in Flintshire meeting the needs of our residents and supporting safer communities
Green Society and Environment	Limiting the impact of the Council's services on the natural environment and supporting the wider communities of Flintshire to reduce their own carbon footprint
Economy	Connecting communities and enabling a sustainable economic recovery and growth
Personal and Community Well-being	Supporting people in need to live as well as they can
Education and Skills	Enabling and Supporting Learning Communities
A Well Managed Council	A responsible, resourceful, and trusted Council operating as efficiently as possible.

<b>4.00</b>	<b>CONSULTATIONS REQUIRED / CARRIED OUT</b>
4.01	<p>The actions/measures detailed within the Council Plan are monitored by the respective Overview and Scrutiny Committees according to the priority area of interest.</p> <p>The Council Plan Mid-Year Performance Report has been to all of the Overview and Scrutiny Committees and no changes have been requested following these meetings.</p>
4.02	Chief Officers and Senior Managers have contributed towards reporting of relevant information.

<b>5.00</b>	<b>APPENDICES</b>
5.01	Appendix 1 - Council Plan 2023/24 Mid-Year Performance Monitoring Report

<b>6.00</b>	<b>LIST OF ACCESSIBLE BACKGROUND DOCUMENTS</b>
6.01	Council Plan 2023/28

<b>7.00</b>	<b>CONTACT OFFICER DETAILS</b>
7.01	<p><b>Contact Officer:</b> Sam Perry  <b>Telephone:</b> 01352 701476  <b>Email:</b> <a href="mailto:sam.perry@flintshire.gov.uk">sam.perry@flintshire.gov.uk</a></p>

<b>8.00</b>	<b>GLOSSARY OF TERMS</b>
8.01	<p><b>Council Plan:</b> the document which sets out the annual priorities of the Council. It is a requirement of the Local Government and Elections (Wales) Act 2021 for organisations to ‘set out any actions to increase the extent to which the council is meeting the performance requirements.’ Plans for organisations should be robust; be clear on where it wants to go; and how it will get there.</p> <p><b>An explanation of the report headings:</b></p> <p><b>Measures (Key Performance Indicators - KPIs)</b></p> <p><b>Actual (YTD)</b> – the year-to-date performance identified i.e., by numbers, percentages, etc</p> <p><b>Target (YTD)</b> – The target for the year to date which is set at the beginning of the year.</p> <p><b>Current RAG Rating</b> – This measures performance for the year against the target. It is automatically generated according to the data.</p> <ul style="list-style-type: none"> <li>• <b>Red</b> = a position of under performance against target</li> <li>• <b>Amber</b> = a mid-position where improvement may have been made but performance has missed the target; and</li> <li>• <b>Green</b> = a position of positive performance against the target.</li> </ul>



# Council Plan Mid-Year Performance Monitoring Report 2023/24

Tudalen 39

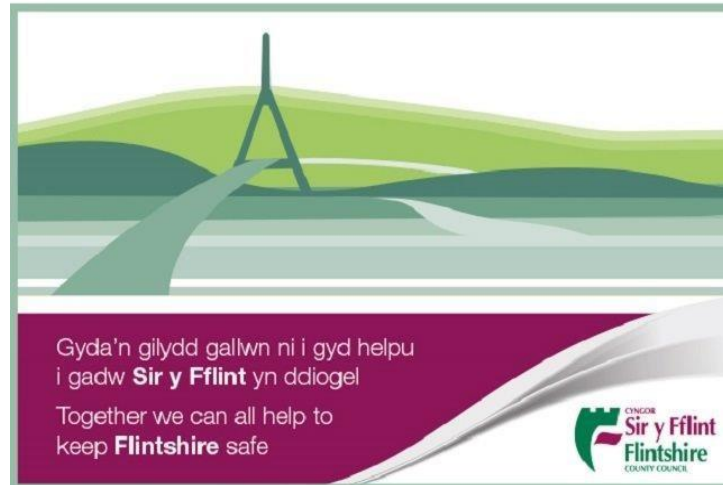

# Contents

Analysis ..... 03

Poverty..... 07

Affordable and Accessible Housing ..... 18

Green Society and Environment ..... 33

Economy ..... 50

Personal Community and Well-being ..... 64

Education and Skills ..... 77

A Well Managed Council ..... 85

Tu  
u  
a  
i  
e  
n  
40



# Analysis

Tudalen 41

Council Plan - Action RAG Status

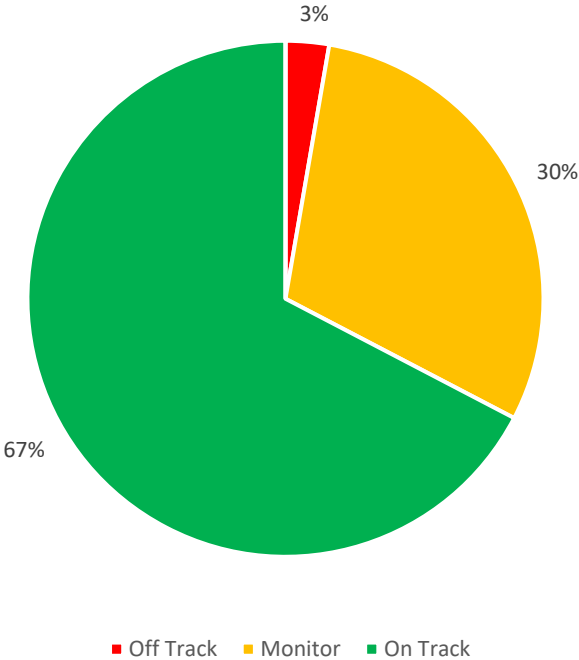

Council Plan - Measure RAG Status

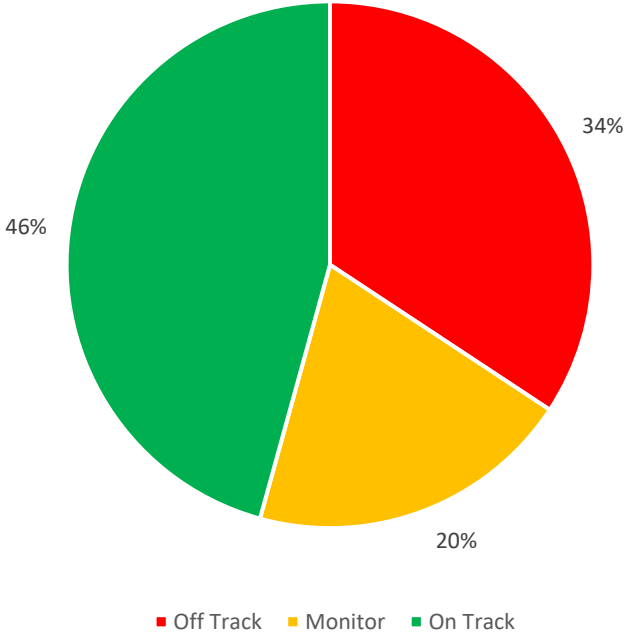

- Key**
- ▲ Red: Limited Progress – delay in scheduled activity and, not on track.
  - Amber: Satisfactory Progress – some delay in scheduled activity, but broadly on track.
  - ★ Green: Good Progress – activities completed on schedule and on track.

## Actions Off Track

Priority	Sub-Priority	Action	RAG
Green Society and Environment	Active and Sustainable Travel Options	Declassification of hazardous routes across the county where appropriate through the implementation of engineering initiatives	▲
	Circular Economy	Develop a Recycling Waste Transfer Station for the deposit and processing of recyclable materials	▲
Economy	Local Development Plan (LDP) Targets	Reference the LDP growth strategy in early work on a North Wales Strategic Development Plan (SDP)	▲
Well Managed Council	Flintshire Assets	Review of Industrial Estate Strategy (Area by Area)	▲

Teddalen 42

## Measures Off Track

Priority	Sub-Priority	Measure	RAG
Poverty	Income Poverty	Total spend of Discretionary Housing Payments (%)	▲
	Food Poverty	Number of residents supported by the “Hospital to Home” meals service	▲
	Digital Poverty	Number of Digital Surgeries held at Connects Centres	▲
Tudalen 49 Affordable and Accessible Housing	Housing Support and Homeless Prevention	Number of presentations to the homeless service	▲
		Percentage of successful relief outcomes for homelessness under Housing (Wales) Act 2014	▲
		Number of households accommodated by the Council under Housing (Wales) Act 2014 homeless duties	▲
		Average length of stay (days) for those households in interim homeless accommodation under Housing (Wales) Act 2014	▲
	Housing Needs and Housing Options	Number of applicants rehoused via SARTH by All Housing Partners	▲
	Social Housing	Number of Council Homes under construction	▲
		Number of Residential Social Landlords (RSL's) homes under construction	▲
		Number of Residential Social Landlord (RSL's) homes completed	▲

Priority	Sub-Priority	Measure	RAG
		Total number of Medium Disabled Adaptations completed	▲
		Total number of Large Disabled Adaptations completed	▲
		Average number of days to complete a Large Disabled adaptation	▲
	Private Rented Sector	Landlords engaged through Flintshire Landlord Forum	▲
Green Society and Environment Judalen 44	Net Zero Carbon Council	Number of contracts with carbon impact assessed	▲
		Percentage of schools accessing the support package	▲
		Percentage of Town and Community Councils accessing the support package	▲
	Circular Economy	Reduce the tonnage of residual waste collected from residential properties	▲
		Increase the tonnage of food waste collected from residential properties	▲
	Economy	Reducing Worklessness	Number of individuals entering employment, learning or volunteering
A Well Managed Council	People	Percentage of employees who have completed all of mandatory modules	▲
	Anti-Racist and Anti-Discriminatory Council	Strategic Equality Action Plan in place and actions achieved	▲
	Digital	80% of telephone calls to the corporate Contact Centre answered	▲

# Poverty

# Poverty Overall Performance

Tudalen 46

### Poverty - Action RAG Status

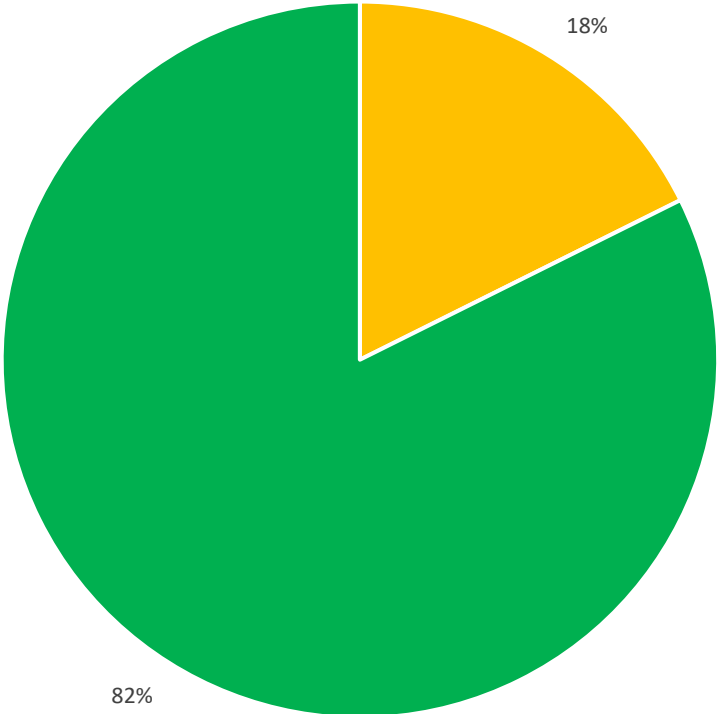

Off Track Monitor On Track

### Poverty - Measure RAG Status

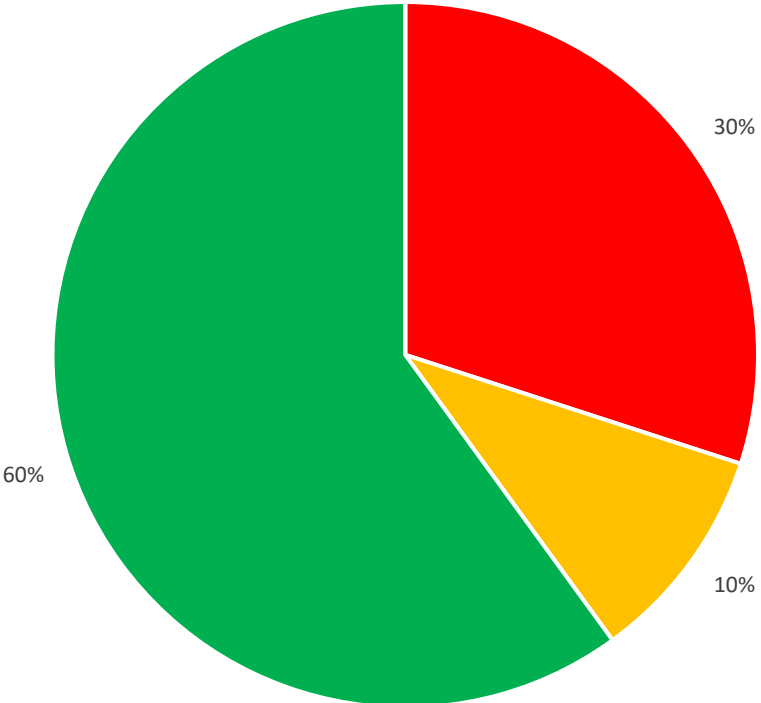



Off Track Monitor On Track

# Income Poverty

Action	Percentage Complete	RAG	Comment
Deliver Welsh Government support schemes linked to the cost-of-living crisis	100%	★	All Welsh Government Cost of Living schemes have now closed. Currently no further schemes have been announced for 2023/24.
Ensuring that take-up to benefit entitlement is maximised in a timely way by processing claims efficiently	50%	★	The improvement in processing times for quarter two, will ensure customers are receiving the benefits and grants they are entitled to quickly, and therefore making the claim process smoother and more satisfactory. This will also encourage the customers to claim again in the future, if they are entitled to do so.
Explore development of support schemes to mitigate in work poverty	100%	★	Currently considering options as to how the Council can help support low income households, who have been significantly affected by the current cost of living crisis, to ensure support enables households to remain in their own homes and mitigating the risk of potential homelessness. The Council also actively promote and successfully administer non standard grant schemes, such as the fuel support schemes.
Further develop our community hub approach giving access to a range of programmes, services and agencies together in one place	90%	★	The Community Support Hub in Shotton has been funded until March 2024. Agencies attend to provide support in 5 key areas: food, income, fuel, digital and mental health. We are working in collaboration with Warm Wales and Citizen Advice Bureau (CAB) to utilise their floating support services and both Warm Wales and CAB visit community led hubs across the County to provide support, especially in regards to the cost of living crisis.
Maximise take up of the Discretionary Housing Payments scheme and other financial support	87%	★	The Discretionary Housing Payment (DHP) expenditure continues to increase due to the additional financial pressures, including higher rent costs and the rise of fuel bills, which has had an impact on tenants ability to pay their rent. Welsh Government are continually encouraging local authorities to use DHP in the prevention of homelessness and to support households in financial need.
Maximise the number of people signposted for support to facilitate longer term change	50%	★	With the continuation of the impacts of the pandemic and the ongoing cost of living crisis, referrals continue to be received and the ongoing advice and support, forms part of the Discretionary Housing Payments (DHP) application process, even if a DHP is unsuccessful. It is envisaged that figures will continue to rise with the increase in fuel prices.

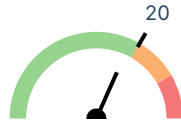
## Income Poverty

Measure	Measure Description	Actual	Target	Last Year	Performance	Performance Trend
CHC001M	Average number of calendar days to process new claims for housing benefit and council tax reduction	19.00	20.00	24.00	 19.00	
<p>Performance has improved by 6 days since quarter one, which brings us back on target. The improvement is a result of recruitment and training, as we are now back to being fully staffed within the Assessment Officer team.</p>						
CHC002M	Average number of calendar days to process change in circumstances for housing benefit and council tax reduction	5.00	8.00	9.00	 5.00	
<p>Performance has improved by one day since quarter one. Recruitment has enabled us to improve our performance and move further within our target.</p>						
CHC003M	Total spend of Discretionary Housing Payments (%)	87.00%	50.00%	80.00%	 87.00%	
<p>Discretionary Housing Payments (DHP) expenditure is exceeding target values due to the increase in DHP applications and support required. This has been the result of the financial impacts amongst households during the cost of living crisis. Currently we receive additional funding via Homeless Prevention Funding and will consider how we can utilise a Discretionary Support Scheme to support households in a broader way.</p>						



# Child Poverty

Action	Percentage Complete	RAG	Comment
Continue to ensure children and young people have access to transitional play/youth activity to support succession from play opportunities into youth clubs to further support young people's development	50%	★	During the spring and summer term, the Play Development Team successfully implemented a transition project for Year 5/6 children. The project aimed to ensure a seamless transition to secondary school by using play as a tool to support their wellbeing. These sessions were active and boosted the confidence of young individuals preparing for the move to secondary school and into youth services age range. We worked with 15 Flintshire schools. A Transition club in Leeswood, was also established.
Contribute to the network of school uniform exchanges across the county supported by enhanced web and social media promotion	100%	✔	A baseline survey was completed with schools during the summer term. This enabled us to establish a full understanding of uniform exchange schemes across the county and help us plan our future support strategy more effectively. Bespoke support was focused at secondary schools during the summer term. The Council website is currently being refreshed to provide further information regarding the uniform exchange schemes.
Encourage further take-up of the free school breakfast for year 7 pupils eligible for free school meals	100%	✔	All secondary schools were able to participate in the pilot project by the summer term of 2023. This national pilot ended in July 2023. Welsh Government are currently evaluating the findings from this.

# Food Poverty

Action	Percentage Complete	RAG	Comment
Continue to develop delivery of a "Hospital to Home" meals service	10%	●	Changes have been made on how the 'Hospital to Home' service will be delivered going forward and in November 2023, a three month pilot will commence to review, analyse and prove the concept can be a success, which will then enable us to attract further funding to support this initiative.
Continue to roll out a transported and delivered food service "Mobile Meals" to those who are vulnerable	100%	★	The Well Fed Meals on Wheels service launched in April 2023, when the successful Croeso Cynnes project ceased. We have received funding to subsidise meals sold on the mobile van visiting rural areas and meals sold at the Well Fed food hubs situated in sheltered community centre's and community led hubs across the County. Since April 2023, the service has proved popular with a high intake of customers.
Further develop the warm spaces initiative in partnership with organisations and third sector	90%	●	The Croeso Cynnes projects ceased in March 2023. Unfortunately we were unsuccessful in our bid for the Shared Posterity Fund to be able to fund the opening of further warm hubs. We have continued to open the sheltered community centres supporting our elderly residents to come together to meet with friends and attend groups/activities, as well as the opportunity to purchase Well Fed Meals. We currently have 16 sheltered community centres open daily.
Introduce and develop a 'Well Fed at Home' service	100%	★	The 'Well Fed at Homes' service launched in April 2023. We have received funding to subsidise the meals sold on the Well Fed mobile shop. The service is proving popular thus far and meals are also being delivered to the sheltered community centres and community led hubs across the County.

Tirialen 50

Food Poverty

Measure	Measure Description	Actual	Target	Last Year	Performance	Performance Trend
CHC005M	Number of residents enrolled in the "Mobile Meals" service	190.00	20.00			
<p>As this is a new initiative, we do not have any previous figures to use as a base line. We initially set a target of 40 customers using the Meals on Wheels service by the end of March 2024. However, we have already surpassed this and in quarter one we had 180 customers and in quarter 2 there has been a further 10 customers using the service, totalling to 190 customers.</p>						
CHC006M	Number of residents supported by the "Hospital to Home" meals service	0.00	74.00			
<p>Changes have been made to the 'Hospital to Home' service and a three month pilot is due to commence in November 2023. Therefore, there is no data available for mid-year.</p>						

Toddalen 51

# Fuel Poverty

Action	Percentage Complete	RAG	Comment
Engage, support and refer vulnerable households to reduce fuel poverty and improve health and well-being	100%	★	Current performance 246 households supported against a target of 150. Measure consists of work carried out on private and public housing stock for pre and post installation work carried out on various property types as well as energy advice, help and guidance for the general public to assist with fuel poverty and the current energy crisis in general.
Reduce the risk of fuel poverty for residents by increasing the energy efficiency of homes	94%	★	Delivered 566 measures against a target of 600. Delivery for April and May 2023, had reduced due to a delay in formatting a Service Level Agreement with Housing and Communities department; agreement now in place. The measure is made up of various component parts delivered by the Domestic Energy Efficiency Project team. Included within the statistic is work carried out on private and public housing stock for renewable heating, gas central heating, loft and cavity insulation and solar photo voltaic installations.

## Fuel Poverty

Measure	Measure Description	Actual	Target	Last Year	Performance	Performance Trend
CPE001M	Total number of households receiving energy efficiency improvements	566.00	600.00	644.00		
<p>Delivery for April and May 2023, had reduced due to a delay in formatting a Service Level Agreement with Housing and Communities department; agreement now in place. The measure is made up of various component parts delivered by the Domestic Energy Efficiency Project team. Included within the statistic is work carried out on private and public housing stock for renewable heating, gas central heating, loft and cavity insulation, and solar photo voltaic installations.</p>						
CPE014M	Providing advice and signposting support to vulnerable households	246.00	150.00			
<p>Current performance 246 households supported against a target of 150. Measured consists of work carried out on private and public housing stock for pre and post installation work carried out on various property types as well as energy advice, help and guidance for the general public to assist with fuel poverty and the current energy crisis in general.</p>						

Tudalen 53

# Digital Poverty

Action	Percentage Complete	RAG	Comment
Provide free access to PCs and internet	100%	★	All our libraries and Flintshire Connects Centres provide free access to PCs and the internet. Aura libraries provide networked access through 'standalone' PCs as well as free Wi-Fi for people to access the internet using their own devices. Staff are available to provide support, and we also offer more formal digital/ICT training at all libraries.
Support people to use digital technology through Digital Workforce Volunteers	25%	●	Recruitment of Digital Workforce Volunteers is underway following trade union approval of the Council's Volunteering Policy. The next step will be to undertake training in partnership with Digital Communities Wales.

## Digital Poverty

Measure	Measure Description	Actual	Target	Last Year	Performance	Performance Trend
CAU024M	Number of digital stations available across the libraries' network	145.00	145.00			
<p>Aura offer standalone PCs in libraries as well as a digital loan scheme that allows people to borrow a device for use in their own home or on site . The digital loan scheme also includes the option of training for those who need additional support as well as help accessing the internet.</p>						
CGV006M	Number of Digital Surgeries held at Connects Centres	0.00	3.00			
<p>Recruitment of Digital Volunteers from across the workforce is underway following Trade Union approval of the Volunteering Policy.</p>						
CGV007M	Number of Sim Cards issued to people in low income households	40.00	15.00			
<p>Flintshire Connects Centres have supported 40 people in digital poverty by providing free data Sim cards in partnership with The Good Things Foundation.</p>						

Tudalen 55

# Affordable and Accessible Housing



# Affordable and Accessible Housing Overall Performance

## Affordable and Accessible Housing - Action RAG Status

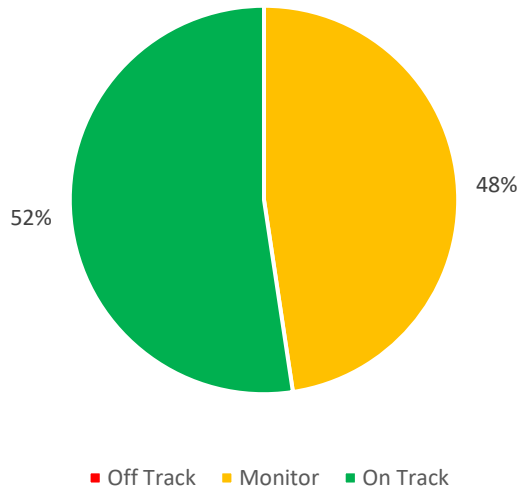

## Affordable and Accessible Housing - Measure RAG Status

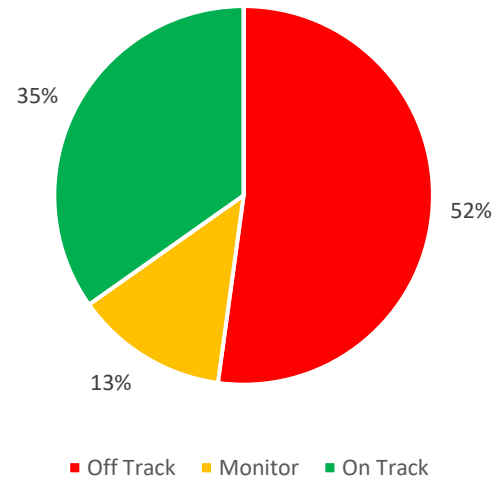

Tudalen 57

# Housing Support and Homeless Prevention

Action	Percentage Complete	RAG	Comment
Commission a wide range of housing related support that meets the needs of the people of Flintshire	20%	●	Completed the re-tendering of all Housing Support Grants funded Domestic Abuse projects. Consultations ongoing regarding Family Supported Accommodation and all Floating Support. Now in a position to tender for a Complex Needs age 25+ supported housing project.
Deliver our Rapid Rehousing Transition Plan	30%	●	Due to increased operational demand for homeless services and limited officer capacity the Rapid Rehousing Plan process is behind schedule. A high level action plan is in place and a job description for Strategic Co-ordinator is awaiting job evaluation ahead of recruitment. Final version of the Rapid Rehousing Transition Plan is to be submitted to Welsh Government in quarter three and development of an "Ending Homelessness Board" is being explored to drive forward the Rapid Rehousing agenda.
Ensure a multi-agency partnership approach to homeless prevention and develop a culture where homelessness is "everyone's business"	50%	★	Strong joint working in place for complex case work and responding to crisis issues as they arise. The last Housing Support & Homeless Forum focussed on ways to improve collaborative working and the group is eager to explore a Complex Case and Advisors Panel where professionals can bring issues of concern around housing and homelessness for advice and guidance before reaching crisis point. Paper also taken to Chief Officers Team in September 2023 to explore ways to ensure homelessness is a shared challenge across all Council services.
Ensure when homelessness does occur it is rare, brief and non-recurring	50%	★	Statutory and Housing Support Grant funded services delivered and commissioned by the Council continue to work on ensuring homelessness is "rare" through positive prevention work and early intervention. When homeless does occur every effort is made to move people on from homeless accommodation quickly so it is "brief" and ongoing support is available to reduce the likelihood of homelessness being "re-occurring". Wales Audit Office have been completing a review of Flintshire's Homeless Services during Quarter 1 and Quarter 2 and the findings of this review are expected in Quarter 3.
Identify a site for a young person's homeless hub offering accommodation and support services	25%	●	Currently revisiting and refining the details of the brief and developing a revised specification with youth justice, homelessness, youth services and social services colleagues for a "Hub" and arranging visits to existing hubs in other authorities to understand the best designs and service configurations.
Progress build project for the new homeless hub accommodation.	50%	●	Feasibility work for supported homeless provision is underway. A potential site has been identified and initial feasibility study in progress, and several options are being explored.
Promote housing support and homeless prevention services with our residents and partners	50%	★	Work continues to promote services through website content and active engagement with residents electronically which for many is a preferred method of sourcing information. Additionally officers regularly attend local activities to promote services and support offers through groups such as Local Community Hubs, Children's Services Forum and Citizen Advice Bureau frontline worker events.

## Housing Support and Homeless Prevention

Measure	Measure Description	Actual	Target	Last Year	Performance	Performance Trend
CHC007M	Number of presentations to the homeless service	907.00	700.00	737.00	<p>907.00</p>	
<p>Presentations to the homeless service continue to be significant. In quarter 1 there were 490 presentations and in quarter 2, 417 presentation. Of those households who identified as at risk of homelessness or homeless and approached the Council for support a total of 644 progressed to a Homeless Assessment (Section 62 Housing (Wales) Act 2014). Those who did not progress were either offered advice and assistance, as they were not at risk of homelessness, ineligible, or further contact was not made when Officers were seeking to undertake the Homeless Assessment.</p>						
CHC008M	Percentage of successful prevention outcomes for homelessness under Housing (Wales) Act 2014	64.44%	70.00%	65.00%	<p>64.44%</p>	
<p>Data still to be validated as part of Welsh Government WHO12 National Reporting. Whilst performance is below target this is still positive performance in light of the current housing conditions when considering the few opportunities there are to prevent homelessness in many cases.</p>						
CHC009M	Percentage of successful relief outcomes for homelessness under Housing (Wales) Act 2014	33.33%	45.00%	45.00%	<p>33.33%</p>	
<p>Data still to be validated as part of Welsh Government WHO12 National Reporting. Performance is below target and is reflective of the current housing conditions. With fewer homes available to meet peoples needs it is an ongoing challenge to help people to exit homelessness.</p>						

Tudalen 59

Measure	Measure Description	Actual	Target	Last Year	Performance	Performance Trend
CHC010M	Number of households accommodated by the Council under Housing (Wales) Act 2014 homeless duties	218.00	150.00	115.00	<p>150</p> <p>218.00</p>	

Demand for homeless accommodation remains high and significant barriers to moving people on through both private rented sector due to limited availability and high rent costs, along with the limited availability of social housing. The significant lack of 1 bed social housing for people under the age of 55 remains the greatest barrier to helping people exit homelessness and this group accounts for approx. 80% of the homeless cohort. The number of households in homeless accommodation increased significantly in quarter 1 but have remained relatively stable in quarter 2 with a slight reduction in Month 6.

CHC011M Tudalen 60	Average length of stay (days) for those households in interim homeless accommodation under Housing (Wales) Act 2014	193.00	130.00	117.00	<p>130</p> <p>193.00</p>	
-----------------------	---	--------	--------	--------	--------------------------	--

Pressures on homeless accommodation continue to be significant with high numbers of households assisted with accommodation due to homelessness. With significant barriers to move on from homeless accommodation due to lack of available social housing of the right types in the right places and a difficult private rented sector, it is not a surprise that people are remaining in homeless accommodation longer. The homeless cohort average stay is 193 but this can be broken down further by household type. Singles and couples without children are reported as 200 day average. Families are reported as 152 days average.

CHC012M	Number of referrals received through the Housing Support Gateway	952.00	700.00	646.00	<p>0.7k</p> <p>952.00</p>	
---------	--	--------	--------	--------	---------------------------	--

For quarter one of 2023-24, the Housing Support Grant Gateway received 419 referrals for support. In quarter two, 533 referrals were received for support. Looking at trends from previous years, and discussing referral levels with other services, a reduction in demand is common during the Q1 period. We gradually saw an increase towards the end of quarter one and saw this increase continue for quarter two.

Figures have increased from previous years, likely due to the fact we have actively been promoting our service and the introduction of a new service wide case management system. The new system has meant services who we would previously not manage referrals for, now receive their referrals via the Gateway, which will increase numbers of referrals passing through our IT system.

# Housing Needs and Housing Options

Action	Percentage Complete	RAG	Comment
Create a Single Point of Access service for housing help and advice	20%	●	A customer journey review workshop has been completed with all staff across the Housing and Prevention Service and a dedicated Homeless Duty Officer is currently being piloted to inform the final stages of the move to a Single Point of Access.
Develop self-service approaches that enable people to identify their own housing options through online support	60%	●	The website is currently under development to include more self-service housing options advice. Developments include a waiting time calculator to be rehoused into Social Housing and eligibility tool.

## Housing Needs and Housing Options

Measure	Measure Description	Actual	Target	Last Year	Performance	Performance Trend
CHC013M	Number of applicants on the Common Housing Register	2,197.00	2,400.00	2,438.00	<p>2,197.00</p>	
<p>At the end of quarter one there were 2297 live applications for Social Housing and by the mid year point there is a decrease of 4%. However, the demand for Social Housing remains high compared to the properties that become available each year.</p>						
CHC015M	Number of applicants rehoused via SARTH by All Housing Partners	257.00	310.00	235.00	<p>257.00</p>	
<p>There have been a total of 117 applicants rehoused in quarter one and for quarter two 140, which gives a total of 257 applicants rehoused at the mid year point. The breakdown is as follows; 24 Clwyd &amp; Alyn, 212 Flintshire County Council and 21 Wales &amp; West to date.</p>						
CHC016M	Number of applicants rehoused via SARTH by Flintshire County Council	212.00	220.00	179.00	<p>212.00</p>	
<p>There have been a total of 121 applicants rehoused into Flintshire County Council properties during the quarter two of this year. 212 applicants have been rehoused at mid year point.</p>						

Tudalen 62

# Social Housing

Action	Percentage Complete	RAG	Comment
Ensure increase in stock capacity meets the identified needs and demands	80%	★	Over 70% of the programme for development consists of one or two bedroom units. The housing prospectus has identified a higher percentage of housing is required for single person households under retirement age and smaller households. There is an historic imbalance in the proportion of housing available to this group. Most council housing consists of two or three bedroom houses for families and sheltered housing for people over the age of 55.
Ensure that any new social housing stock meets Development Quality Requirements (DQR) standard energy efficiency A rating	100%	★	All properties completed have been designed to meet Development Quality Requirements and will achieve an energy efficiency rating of A.
Finalise the plan for the de-carbonisation of Council homes in line with Welsh Government guidance to ensure their thermal efficiency is optimised and the cost of heating homes are minimised	50%	★	The Decarbonisation Strategy is currently in draft form and the service is currently reviewing associated work programmes and plans. The Strategy will be finalised alongside the programme of works over the next 3 years in line with Welsh Government deadlines. The delayed launch of WHQS 2023 has impacted upon our timescales. Contract Holder and Member workshops will be organised and updates conveyed through Programme Board meetings, Housing Scrutiny and management team meetings.
Implement the initial recommendations of the sheltered housing review to ensure that it continues to meet the needs of current and prospective tenants	50%	★	The Sheltered Housing review task group have now met and agreed the terms of reference. The task group will meet over two additional meetings, to agree the methodology and also the consultation process. Once this has been agreed and the task group finalised, the Sheltered Housing review will continue and officers will progress with the Council owned sheltered complex's across the county, moving forward with the recommendations following each review.
In partnership with Denbighshire Council, create a new Dynamic Procurement System in order to ensure CPR's are met and provide a wider opportunity for tendering Disabled Adaptation projects	70%	●	Currently Flintshire County Council and Denbighshire County Council staff are meeting with Procurement every few weeks, to ensure progress is occurring on the creation of the Dynamic Procurement System, with a view to it being ready early 2024.
Increase the Council's housing portfolio by building social housing properties and affordable properties for North East Wales (NEW) Homes	80%	★	Main schemes have been delayed in the programme to quarter one of 2024-25. We anticipated the total number of new properties for the Council and NEW Homes stock will be 52, plus any additional buy backs that can be completed by the end of the financial year.
Maximise Welsh Government Funding to increase stock capacity	100%	★	All schemes are designed to maximize the amount of funding, while providing the optimum number of properties on each scheme.
Work with housing association partners to build new social housing properties and additional affordable properties	40%	●	There have been some delays in the programme with two large schemes at Northern Gateway and Mynydd Isa requiring the employment of two new main contractors and awaiting on decision from Welsh Government regarding additional funding. However we anticipate being on site by the end of the year for over 170 properties. As a consequence the number completed this year will be reduced to 20 properties.

Action	Percentage Complete	RAG	Comment
Work with residents to ensure our communities are well managed, safe, and sustainable places to live	75%	●	Regular 'Housing Surgeries' are held in various communities within the County, with Housing Officers and contract holders attending to ensure our communities are well managed, safe, and sustainable. Housing Officers are also more visible on their 'patch' areas.

Tudalen 64



## Social Housing

Measure	Measure Description	Actual	Target	Last Year	Performance	Performance Trend
CHC018M	Number of Council Homes under construction	3.00	14.00	36.00		
<p>Schemes have slipped in the program and are currently at the Welsh Government Technical Approval stage before the Planning applications can be made with a view to being on site in the first quarter of 2024/25.</p>						
CHC019M	Number of Council Homes completed	36.00	4.00	0.00		
<p>While the figures show that we are ahead of programme this year with number of homes completed, this is a result of slippage from the schemes included in the last financial years figures.</p>						
CHC020M	Number of Affordable Homes under construction via NEW Homes	13.00	13.00	5.00		
<p>We are currently on target to achieve the completion of NEW homes properties under construction within the financial year.</p>						
CHC021M	Number of Affordable Homes completed via NEW Homes.	0.00	0.00	0.00		
<p>Properties currently under construction are on target for completion by the end of the financial year 2023-24.</p>						

Tudalen 05

Measure	Measure Description	Actual	Target	Last Year	Performance	Performance Trend
CHC022M	Number of Residential Social Landlords (RSL's) homes under construction	21.00	96.00			
<p>There has been slippage on two large schemes (156 units) at Northern Gateway and Mynydd Isa where both main contractors have gone into liquidation requiring the engagement of new Contractors. There has also been a delay while waiting on a decision from Welsh Government regarding additional funding on some of the schemes. We anticipate that these schemes will be on site under construction in the fourth quarter of 2023/24.</p>						
CHC023M	Number of Residential Social Landlord (RSL's) homes completed	8.00	17.00			
<p>Eight properties have been completed so far this year and the remainder are expected to be completed by the end of this financial year.</p>						
CHC026M	Total number of Small Disabled Adaptations completed	638.00	160.00			
<p>We are completely reliant on the Occupational Therapist referrals, therefore it is very difficult to predict targets. We are, however, currently looking at data regarding this increase in demand as the demand has been increasing since 2021 by nearly 50% each year.</p>						
CHC027M	Average number of days to complete a Small Disabled adaptation	14.00	28.00			
<p>Small Adaptations are being completed by Care and Repair contractors and they have taken on more staff to alleviate the high demand to ensure targets as set out by Welsh Government Housing Standards are still being met.</p>						

Tudalen 66

Measure	Measure Description	Actual	Target	Last Year	Performance	Performance Trend
CHC034M	Total number of Disabled Adaptations completed	680.00	214.00			
<p>This figure is considerably higher than the estimated target due to the increase in demand of small adaptations.</p>						
CHC039M	Total number of Medium Disabled Adaptations completed	39.00	50.00			
<p>We are reliant on Occupational Therapist referrals for any adaptations, we do not have any control over the amount we receive, neither are they in control of the amount of requests they receive from members of the public. It is therefore difficult to set a target so we use the previous years figures to set the target.</p>						
CHC042M	Average number of days to complete a Medium Disabled adaptation	108.00	122.00			
<p>Medium adaptations do vary in timelines as some cases can be straightforward, but others are more complicated. However, overall we are completing them within the requested timeline as set out by Welsh Government Housing Standards.</p>						
CHC043M	Total number of Large Disabled Adaptations completed	3.00	4.00			
<p>Similar to medium adaptations it is difficult to set a target apart from looking at previous years. Large adaptations are even more difficult to ascertain when they will complete as some are slower than others due to their complexity and designs. Some need planning, others don't and some contractors can start quicker than others. Currently, we have 2 large cases with works ongoing, 2 cases with a contractor waiting to start, 2 cases out for tender and 6 cases currently being worked on by the surveyor.</p>						

Tudalen 67

Measure	Measure Description	Actual	Target	Last Year	Performance	Performance Trend
CHC044M	Average number of days to complete a Large Disabled adaptation	693.00	456.00		<p>456 693.00</p>	

Positively, a number of large legacy cases were completed in the first quarter of this financial year, however, in doing so this had an adverse effect on our target. As all legacy cases have now been completed, the average number of days to complete large cases will start to reduce.

# Private Rented Sector

Action	Percentage Complete	RAG	Comment
Create a Private Sector Housing Support Team	30%	●	As part of the Housing & Prevention Service restructure a new Homefinder Team will be established including Housing Advice, Housing Register, management of Homeless Accommodation and Private Sector and Landlord Support. Recruitment to Homeless Accommodation staff is underway following vacancies and new posts in the job evaluation process and fully costed within service budget and Housing Support Grant.
Engage with private sector tenants, giving them a voice, and responding to their needs	50%	★	Active engagement with residents who are experiencing housing problems in the private rented sector and for those seeking rehousing in the private sector is ongoing through casework. In response to residents concerns over rent in advance and the need for enhanced deposits we have allocated a significant proportion of our Discretionary Homeless Funding and Spend to Save budgets to this issue and we are also exploring opportunities for Rent Guarantee Scheme. The Regional Tenant Pulse Group led by TPAS (Tenant Participation Advisory Service) Cymru continues to meet to engage with private sector contract holders and to produce information for these residents.
Work in partnership with landlords and private sector agents to better understand their needs	50%	★	We continue to use social media as a way to reach out to landlords and also use the the Council Newsletter and Rentsmart Wales Targeted Landlord engagement streams to promote Flintshire Landlord Support Services and the Landlord Forum. We have also completed a refresh of the "state of the Flintshire Private Rented Sector report" for the months January - June 2023 to review the availability and movements of private rented homes in Flintshire and this research actively engages with Lettings Agents in Flintshire, all of whom confirm the demand far outstrips supply and availability is down significantly on previous years, and costs increasing at a time when housing is needed the most. Some landlords are still actively exploring sale of their homes and leaving the market place. Additional demands on the limited available homes locally are emerging through activities such as the Home Office Asylum Seeker Resettlement Scheme.

Private Rented Sector

Measure	Measure Description	Actual	Target	Last Year	Performance	Performance Trend
CHC040M	Landlords engaged through Flintshire Landlord Forum	25.00	40.00			

This is a new measure so this year will form the baseline data for future targets. The Landlord Forum aims to meet four times a year and last met in May 2023 with 25 landlords and or lettings agents attending. The focus of the Forum was on Financial Support for Landlords and Residents. A further Forum was planned for September 2023 but had to be cancelled but will be picked up in quarter 3 and will focus on Resident Welfare and Complex Housing Needs.

Tudalen 70

# Green Society and Environment

# Green Society and Environment Overall Performance

Tudalen 72

### Green Society and Environment - Action RAG Status

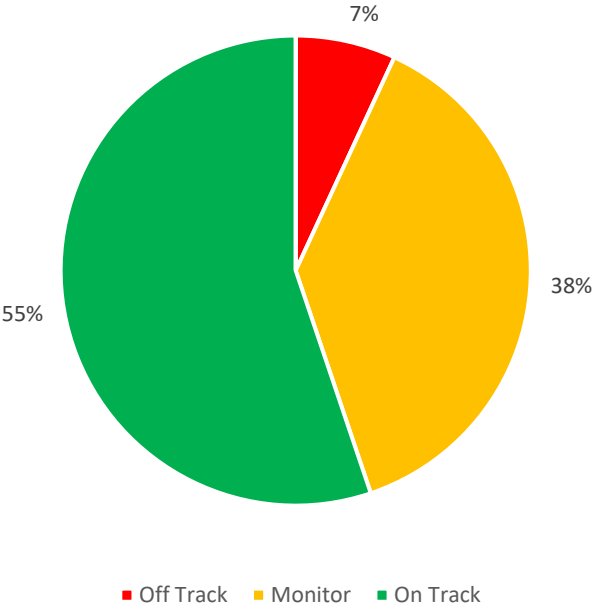

### Green Society and Environment - Measure RAG Status

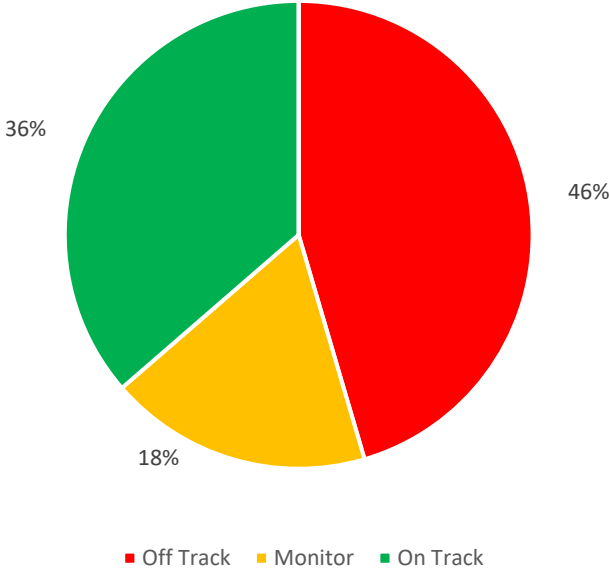



# Phosphates Mitigation

Action	Percentage Complete	RAG	Comment
Produce guidance on viable and deliverable options to mitigate the impact of phosphates from new development on Special Areas of Conservation (SAC) protected rivers	50%	●	The adoption of the Local Development Plan (LDP) was premised on the basis of certain allocated housing sites having to demonstrate nutrient neutrality in terms of not harming the Bala Lake and River Dee Special Areas of Conservation (SAC) through the release of phosphates from waste water treatment works into the River Alyn. Work commenced on the feasibility of developing wetlands alongside 3 waste water treatment works at Mold, Buckley and Hope, which would have required developer financial contributions as part of a process which was to have been set out in Supplementary Planning Guidance (SPG). However, the release of updated and unchanged permits for the three waste water treatment works by Natural Resource Wales and the availability of 'headroom' (difference between the level of phosphate permitted by the permit and the actual level of phosphate being released by the treatment works) evidenced by Dwr Cymru (Welsh Water) has provided a window within which to deliver LDP allocations. However, in the longer term it will be necessary to revisit mitigation measures and the production of SPG to address phosphates and this is being overseen by the Dee Nutrient Management Board.

# Net Zero Carbon Council

Action	Percentage Complete	RAG	Comment
A net zero carbon Council by 2030 and supporting wider decarbonisation actions across the County, making this central to Covid-19 recovery	10%	★	The Council's carbon footprint for 2022-23 has been calculated and reported to Welsh Government. This report is due to Cabinet in November. The programme of activities to decarbonise the Council's carbon emissions continues to work to plan meeting interim targets. The programme's communication and engagement plan has assisted in ensuring all stakeholder groups are engaged with the programme, and members of the public and private sector are also engaged in carbon reduction and climate change awareness activities. This is a long term target taking us to 2030, and we are currently on target at 10%, giving us a green RAG status.
Develop plans towards net zero carbon for our assets in line with Welsh Government guidance	60%	★	Short term energy efficiency and renewable energy installations continue to be carried out across our building stock including schools, care homes, leisure and industrial as external funding allows. Work with Welsh Government Energy Service has highlighted an opportunity to utilise regarding Fit Procurement Framework for further short to medium term works and this will hopefully be finalised before year end.
Review the procurement policy to reduce greenhouse gas emissions from suppliers	100%	★	The Procurement strategy has been drafted and is awaiting Cabinet approval in November 2023. The strategy incorporates ambitions through Procurements to tackle carbon reduction and for suppliers to demonstrate how they will reduce their carbon footprint.
Work with Flintshire's leisure and culture trust partners to reduce carbon emissions	50%	★	The Climate Change team continue to engage with leisure and culture trust partners to establish their carbon footprint and work to decarbonise these assets and services. These include AURA, NEWydd Catering and Cleaning, and Greenfield Valley Heritage Trust where carbon emission data is being collated and then a carbon reduction plan can be developed.

74

Net Zero Carbon Council

Measure	Measure Description	Actual	Target	Last Year	Performance	Performance Trend
CPE020M	Number of contracts with carbon impact assessed	0.00	5.00			
<p>A joint Procurement Business Partner for Decarbonisation starts in September 2023 and will focus on developing and implementing the process for establishing supplier's actual carbon emissions as part of their contract.</p>						
CPE021M	Percentage of schools accessing the support package	0.00%	5.00%			
<p>Support package is now ready for piloting with schools during October 2023 - March 2024.</p>						
CPE022M	Percentage of Town and Community Councils accessing the support package	0.00%	5.00%			
<p>Offer to Town and Community Councils will be made during October 2023 - March 2024.</p>						

Tidalen75

# Climate Change and Adaptation

Action	Percentage Complete	RAG	Comment
Assess the feasibility of schemes within land assets for resisting flood and drought while enhancing biodiversity and increasing carbon storage	80%	★	Work has been carried out between both Climate Change and Biodiversity teams to identify land assets that would be appropriate for such schemes. All land assets have been assessed through a matrix considering a number of criteria including flood risk, potential for development, biodiversity value, etc. This desktop exercise has highlighted a small list of potential sites for schemes. This needs to be further investigated and scoped to create a final list of feasible assets.
Carry out flood investigations and alleviation works where appropriate	100%	★	This is an ongoing exercise that is part of the normal function of the Flood and Coastal Risk Management Team. The priorities for this work will be assessed as part of the review of the Council's Flood Risk Management Strategy(which also forms part of another action within the Council Plan 2023-28)
Ensure climate change and biodiversity are considered a priority in key decision making across all Council services	50%	●	Piloting of a new Integrated Impact Assessment is underway in partnership with Manchester University. This new tool ensures that decisions affecting carbon impacts, biodiversity impacts, equalities and welsh language. Process and roll out being reviewed and planned for coming months.
Identify projects to further support climate adaptation ambitions following Welsh Government guidance	30%	★	Research has been carried out to establish best practice and collate risks relevant and applicable to the county of Flintshire. Workshops with stakeholders to define risks and mitigation actions are being carried out during October 2023 - March 2024.
Review the Council's Flood Risk Management Strategy	25%	●	Work has begun on the review of the Flood Risk Management Strategy with consultants, where key issues are being identified to use to prioritise the focus for the strategy. Work has also been done to develop a draft set of objectives and measures, which together with the key issues will then form the basis for officer, stakeholder, and Elected Member engagement autumn 2023.
Review the Council's Strategic Flood Consequences Assessment	95%	●	Due to further delays with the re-issue of TAN15 the SFCA has yet to be submitted to Welsh Government. It is complete and officer comments were fed back to the consultants in October 2023 in order for these to be considered and a final Report issued.

# Flood Risk Management Strategy

Action	Percentage Complete	RAG	Comment
Review the Council's Flood Risk Management Strategy	25%	●	Work has begun on the review of the Flood Risk Management Strategy with consultants, where key issues are being identified to use to prioritise the focus for the strategy. Work has also been done to develop a draft set of objectives and measures, which together with the key issues will then form the basis for officer, stakeholder, and Elected Member engagement autumn 2023.

# Strategic Flood Consequences Assessment

Action	Percentage Complete	RAG	Comment
Review the Council's Strategic Flood Consequences Assessment	95%	●	Due to further delays with the re-issue of TAN15 the SFCA has yet to be submitted to Welsh Government. It is complete and officer comments were fed back to the consultants in October 2023 in order for these to be considered and a final Report issued.

Tudalen 78

## Strategic Flood Consequences Assessment

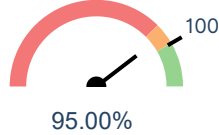
Measure	Measure Description	Actual	Target	Last Year	Performance	Performance Trend
CPE026M	Percentage compliance with Welsh Government delivery timetable	95.00%	100.00%		 <p>95.00%</p>	

Due to further delays with the re-issue of Technical Advice Note (TAN15) of the Strategic Flood Consequences Assessment, has yet to be submitted to Welsh Government. It is complete and officer comments were fed back to the consultants in October 2023 in order for these to be considered and a final report issued.

# Green Environment

Action	Percentage Complete	RAG	Comment
Deliver an increase in canopy cover as part of the Urban Tree and Woodland Plan	50%	★	Tree planting planning for 2023-24 is near completion with planting site preparatory works undertaken and tree orders, events and deliveries planned for the winter 2023.
Develop a strategy to improve biodiversity and carbon sequestration on the agricultural estate	20%	●	Decisions around strategy to engage farmers with carbon action hinges on Welsh Government's new Agricultural payment scheme and its approach towards sustainable farming. Climate Change Committee have approved the development of a decision making tool for land assets when they become available, to ensure that all considerations are made for the land in meeting the Council's ambitions and targets, before the land is disposed of. This work will continue over the next financial year.
Enhance the natural environment through the delivery of the Section 6 Environment (Wales) Act 2016 biodiversity duty	60%	★	There is improved cross department working with strengthening initiatives across a range of Portfolios, including Streetscene (grounds maintenance and pesticide reduction), Regeneration (green infrastructure in urban areas), Education (school grounds enhancement), Housing, Climate change and Energy. Improved consideration of the duty through well established links with other key Council documents. There has also been an improved delivery of collaborative regional nature partnership through part funding of a Nature Partnership Project Officer and an increase in Biodiversity officers capacity due to grant funding. The Nature E-learning module for officers is progressing well. Public engagement has increased through social media, events, publications and recently installed QR codes at appropriate wildflower sites. An updated and revised application for Bee Friendly status is ongoing and will be submitted by the end of 2023.
Progress Ash Dieback Action Plan	30%	●	An update report was discussed at Environment and Economy Overview and Scrutiny in September 2023. Survey of high priority roads and school grounds has been completed but secondary roads and open spaces are ongoing. Planning to mitigate high risk Council owned trees is underway and notification of private landowners is ongoing. However, the inability to recruit key staff is having an impact in the ability to deal with the disease.



# Flintshire Forest

Action	Percentage Complete	RAG	Comment
Develop a Flintshire Forest Plan	20%	●	Report to Scrutiny in 2022-23 to set the direction of a Flintshire forest principal. Work to understand available land for tree planting is proving challenging. Work on draft plan not started due to other priorities.

# Green Access

Action	Percentage Complete	RAG	Comment
Deliver the Rights of Way Improvement Plan with a focus to ensure improved access for all and the promotions of Walking for Health	50%	★	Installed 14 Kissing gates (target 40) and improved 1367sqm of surface (target 3,000sqm). Complete cases - 2 Definitive Map Modification Order, 1 Public Path Order. Re-establish Local Access Forums and complete and consolidate the definitive map. We are on target to have a draft ready for public consultation by March 2024
Explore opportunities to develop the Flintshire Coast Park through the production of a scoping study	50%	★	Scoping study complete in 2022-23. Successful in our bid to the Shard Prosperity Fund to develop the transitional phase. A Development Officer was successfully appointed in September 2023 and work is ongoing to develop key plans.

Tudalen 82

# Active and Sustainable Travel Options

Action	Percentage Complete	RAG	Comment
Declassification of hazardous routes across the county where appropriate through the implementation of engineering initiatives	15%	▲	A list of the Counties' Hazardous Routes has been compiled. Following completion of infrastructure schemes, routes will be reviewed in accordance with the Learner Travel Guidance to ascertain compliance and will request political approval.
Implement formalised crossing facilities at existing school crossing patrol sites	50%	★	Crossing surveys and summary report have been completed. Design to progress and priority sites will be completed in 2023/24.
Implementation of 20mph national legislation	100%	✔	The 20mph national legislation was implemented on 17 September 2023.
Promote active travel and further develop the County's walking and cycleway network	75%	★	2023/24 active travel schemes will be completed by the end of the financial year.
Support the development of public electric vehicle charging network	45%	★	A total of four electric charge points have been installed on the recently constructed Park and Ride facility on Zone 2 Deeside Industrial Park. A further 17 publicly accessible charging points have now been implemented within nine Flintshire car parks. This work is now complete and charge points are fully operational. Welsh Government funding has been received this financial year for the progression of a County wide feasibility study for the expansion of the Council's public charging infrastructure. Once complete, this will serve as the Council's strategy going forward.

Trealen 83

## Active and Sustainable Travel Options

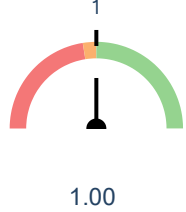
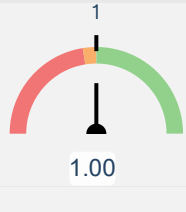
Measure	Measure Description	Actual	Target	Last Year	Performance	Performance Trend
CST014M	Number of formalised crossing facilities implemented at existing School Crossing Patrol sites	1.00	1.00		 <p>A semi-circular gauge with a red section on the left and a green section on the right. A vertical needle points to the number 1.00 at the top center of the gauge.</p>	
<p>Crossing surveys and summary report have been completed. Design to progress and priority sites will be completed in 2023/24.</p>						
CST015M	Implementation of 20mph speed limits on the County's restricted roads.	1.00	1.00		 <p>A semi-circular gauge with a red section on the left and a green section on the right. A vertical needle points to the number 1.00 at the top center of the gauge.</p>	
<p>The 20mph was implemented on 17 September 2023.</p>						

Tudalen 84

# Circular Economy

Action	Percentage Complete	RAG	Comment
Achieve Welsh Government recycling targets	50%	●	While the statutory recycling target for 2023/24, is 64%, we aspire to meet the target of 70% ahead of 2024/25. Our year end recycling performance for 2022/23 fell short of the 64% target resulting in potential additional infraction fines by Welsh Government. A review of the Waste Strategy is currently ongoing with the Waste and Resource Action Programme (WRAP) and Local Partnerships (commissioned by Welsh Government) as recent compositional analysis of the residual waste bins shows that a high proportion of waste put in them could be collected via the weekly recycling service. Residents of Flintshire have been asked to support the Council in achieving these targets by making use of the recycling containers provided. Evaluation of any improvement will be reviewed in the autumn.
Develop a Recycling Waste Transfer Station for the deposit and processing of recyclable materials	0%	▲	This relates to the project referred to as 'Standard Yard', where funding was secured to develop and build a dedicated transfer station for the authority. Due to inflationary changes to the economy, the available grant funding no longer covers the cost of the project. The long-term feasibility of the project is currently being reviewed by Streetscene with the support of local partnerships.
Promote the option to reuse and repair unwanted items at Household Recycling Centres by partnering with local Charities or social enterprises	50%	●	A funding bid to introduce a reuse initiative across all Household Recycling Centers was submitted to Welsh Government for Circular Economy Funding in June 2022. The outcome of that bid is still yet to be determined. A letter was received from Welsh Government in April 2023 stating that the outcome had been delayed, this was due to pressure on public sector budgets. We remain in contact with Welsh Government colleagues to receive updates on decision timelines.
Work in partnership, actively support and engage with community led groups by developing recycling initiatives	100%	★	The waste strategy team have been actively engaging with communities in Flintshire to promote our recycling and reuse services. This has taken place at local fairs, community group meetings and on the door step. A number of community groups have reached out to the team to actively support and promote recycling. With the introduction of three additional Recycling, Compliance and Data Officers from the end of the year, community engagement will increase.

Tudalen 85

## Circular Economy

Measure	Measure Description	Actual	Target	Last Year	Performance	Performance Trend
CST004M	Percentage of waste reused, recycled or composted	66.59%	70.00%	64.17%		
<p>The recycling percentage for quarter one was 66.59%, an increase of 3.8% in comparison to the same period in the previous year. This increase has been predominantly due to an increase in garden waste collected.</p>						
CST005M	Average Recycling rate across Household Recycling Centres (HRCs)	83.00%	80.00%	81.40%		
<p>The household recycling centre recycling performance remains consistently high, contributing to the overall increase in recycling performance for the authority.</p>						
CST017M	Reduce the tonnage of residual waste collected from residential properties	0.00%	5.00%			
<p>The amount of residual waste collected form residential properties did not reduce in quarter one in comparison to the same period of time in the previous year.</p>						
CST018M	Increase the tonnage of food waste collected from residential properties	-4.00%	7.00%			
<p>The amount of food waste collected for quarters one and two has decreased by 81 tonnes in comparison to the same period of time in the previous year resulting in the amount of food waste collected decreasing by 4%.</p>						

Tudalen 86

Measure	Measure Description	Actual	Target	Last Year	Performance	Performance Trend
CST021M	Number of education campaigns on recycling and waste minimisation undertaken to improve recycling performance	3.00	3.00			

Progress on education campaigns has been affected by lack of resource in the Waste Strategy Team. A leaflet was issued to all residents in April 2023, to inform of the need to recycle. Community engagement has taken place at local fairs and community events. Recycling participation studies have begun with the aim of identifying areas in the community that do not engage with recycling with an aim to target education campaigns. Multi lingual kerbside recycling Leaflet has been utilised which offer information on household recycling centres (HRC) and bulky waste collections. The new leaflets will be delivered to households with the new collection calendars, they will also be available on the FCC Website for residents and landlords to download.

# Economy



# Economy Overall Performance

Tudalen 89

### Economy - Action RAG Status

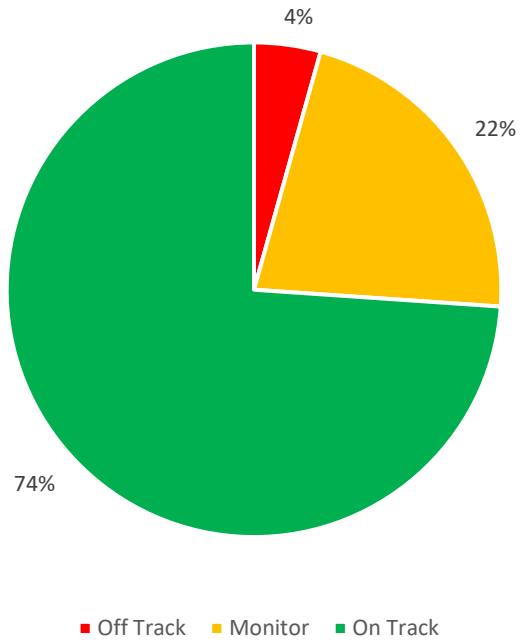

### Economy - Measure RAG Status

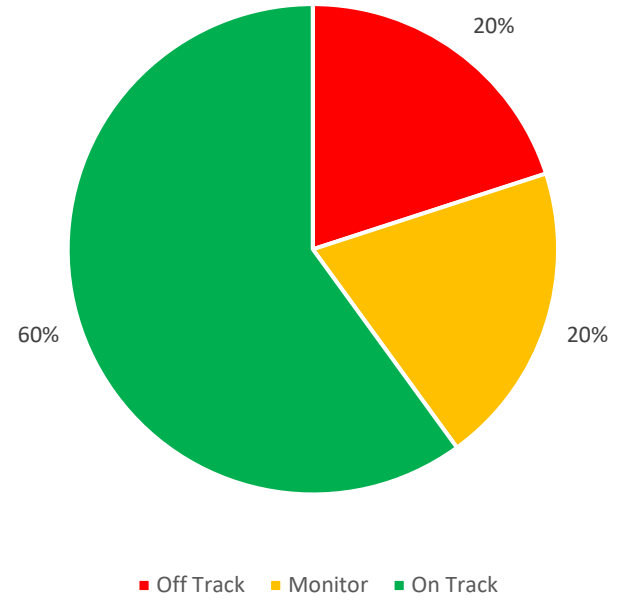

# Rural Regeneration

Action	Percentage Complete	RAG	Comment
Commission a data review for rural Flintshire and hold community consultation to better understand rural community needs	0%	★	This work is not due to commence until the second half of 2023-24 and is still expected to do so.
Ensure that Economy interventions consider and meet the needs of rural businesses and individuals.	0%	★	The development of this work stream isn't due to commence until the second half of 2023-24.
Recruit a Digital Connectivity Officer to support rural communities to access better quality connectivity options	50%	●	Following a successful budget pressure bid for 2023-24 onwards the role of Digital Connectivity Project Officer has been designed. The new role will be the operational lead for encouraging the development of digital connectivity infrastructure (outside of Council business operations) and in encouraging greater adoption of new technologies by communities and businesses. A second recruitment campaign to fill the role is currently underway, the first campaign having been unsuccessful.

Tudalen 90

# Town Centre Regeneration

Action	Percentage Complete	RAG	Comment
Encourage and support investment in town centre properties specially to facilitate more sustainable uses and including improvements to the environment	80%	★	In quarter 2, ten individual town centre investment projects have been awarded capital grant funding, with an overall capital investment value of £1,201,989. Of this £629,581 (52.4%) is direct private sector contributions and £572,408 is secured from Welsh Government's Transforming Towns initiative/ Welsh Government's Shared Prosperity Funding. Each scheme enables vacant, run down and/or poor condition premises to be improved or brought back into use and become more sustainable in terms of usage/ energy efficient. At the end of September 2023, there are a further 11 projects currently under development, including four schemes seeking Transforming Towns Regeneration Repayable Loans. Work is ongoing to encourage applicants to apply for funding which is already 67.5% committed to date (£202,532 of £300,000) available for 'Town Centre Property Improvement Grants' in 2023-24 to date.
Engage town centre small businesses and promote support packages available to them	80%	★	The Council's Regeneration team has received 54 enquiries about support/ funding into the business e-mail account April - September 2023, in response to information advertised about grant funding and support available. 29 of 54 (53.7%) of these enquiries were received in quarter two (July - September 2023) and 100% response rate achieved. In addition to this, direct phone calls and conversations with businesses have been taken place in response to targeted in-person promotion and marketing being implemented by the Regeneration team. A range of forums have been attended by the Council, including Holywell Business Forum and Buckley Working Group, where information about support packages have been shared. Furthermore, content on the Council's website has been updated to promote additional funding secured, invite applications for grant funding and provide an overview of opportunities available as a result of £1.178 million Shared Prosperity Funding being secured in July 2023, for investment in seven town centres across Flintshire. Targeted information about opportunities available in town centres have also been circulated to Elected Members and town councils in Buckley, Connah's Quay, Flint, Holywell, Mold, Queensferry and Shotton.
Libraries and leisure centres are community well-being hubs with social objectives underpinning their operation	50%	★	Aura continues to operate four leisure centres and seven libraries (plus the mobile library and home library service).
Monitor the health and vitality of town centres to support effective management and business investment decisions	50%	★	Work to monitor the health and vitality of town centres is ongoing and on schedule as planned for 2023-24. A six monthly summary report regarding footfall (using SMART Town devises) is currently being developed, using data gathered between April and September 2023. Key findings will be circulated as part of a wider Regeneration Newsletter to each town council in seven targeted towns across Flintshire. Ongoing enquiries are generated from event holders and town councils regarding the impact of specific events on footfall. The Regeneration team continues to respond to these enquiries. Direct feedback is also gathered from businesses that are engaging with the Council and this informs targeted approaches to identifying issues that may be detrimental to the health and vitality of our towns (i.e. notification of a business closure instigates attempts from the Regeneration team to contact landlord/businesses regarding support and assistance available).
Understand the needs of and supporting community enterprises in town centre locations	70%	★	Ten individual social enterprises have been supported over during quarter two (July - September 2023), from across five town centres in Flintshire: Buckley 1, Connah's Quay 3, Mold 1, Queensferry 2 and Shotton 3. Enquiries handled and support provided has involved the Council's Business Development and Regeneration teams for support, such as exploration of grant funding opportunities and seeking new and/or alternative town centre premises to operate from. Enquiries about premises have also been explored with Assets team in relation to possible lease options and costs.

Town Centre Regeneration

Measure	Measure Description	Actual	Target	Last Year	Performance	Performance Trend
CAU025M	Average number of weekly public opening hours available within leisure centres and library branches in Flintshire towns	536.00	536.00		 <p>536.00</p>	

Opening hours of Aura’s four leisure centres and seven libraries remain relatively static with no reduction in service levels. Opening hours can be subject to short term minor tweaks from time to time but this is due to the need to be responsive to customer needs rather than a reduction of the offer.

# Business

Action	Percentage Complete	RAG	Comment
Increase the scale and impact of the social business sector	50%	★	During April - September 2023, 79 free business support sessions was delivered to 31 social enterprises within the County. The Social Enterprise Lead Officer continues to work in partnership with the Flintshire Social Impact Stakeholder Group on the bespoke Flintshire Social Impact Toolkit which has been developed to evidence the financial value of social enterprise activity. This toolkit now measures 14 activities, during this reporting period the value captured by the toolkit is £735,927.29 The Social Enterprise Lead Officer has carried a self-assessment across the local authority to look at how the Council works with Social Enterprises and identify better ways of working.
Support growth of the local and regional food and drink business sector through marketing and collaborative projects	55%	★	The Council supported Mold Food and Drink Festival with a successful event held in September 2023. Ongoing financial support is available for Clwydian Range Food and Drink activities to research local food and drink products, their availability and also supply and demand by the tourism sector within the Clwydian Range and Dee Valley Areas Of Natural Beauty. A recent local Food and Drink networking event with Flintshire Tourism Association provided an opportunity for local food and drink producers to showcase their products to 75 attendees (tourism and hospitality businesses).
Support local businesses in their efforts to reduce their carbon footprint and become more resource efficient	50%	★	In partnership with the Council, Deeside Decarbonisation Forum has delivered two network events since April 2023 and engaged with 105 business delegates. The events are designed to share best practice within private sector decarbonisation work programmes and encourage business collaboration across the County. Shared Prosperity Fund has been awarded to support a number of carbon reduction projects across the County (ranging from private sector business grants to academic research), to encourage businesses to adopt greener technologies, reduce carbon footprints and become more resource efficient.
Support recovery of the County's street and indoor markets	50%	★	Mold Street Market continues to thrive with an average of 66 traders attending each market day and 13 new traders have been accommodated since April 2023, replacing retired stallholders. Mold Indoor Market has attracted four new stall holders and is currently 100% occupied. Holywell Market numbers remain low with an average of seven traders (five existing plus two new stalls) each week. Market events and activities such as Easter Markets and school holiday family markets (which offer Disney characters/ face painters etc) increases footfall from residents and visitors to the towns. Approximately three group travel coaches attend Mold each month, from across the UK including Scotland, Northumberland and Holyhead.
Support recovery of the tourism and hospitality sectors and rebuild confidence in the industry	55%	★	North East Wales 'Year of Trails' marketing activity have completed three films so far; Dark Skies, Winter, and Breath-taking Trails. £64,000 was secured from Cadwyn Clwyd by the Flintshire Tourism Association to support wider business support and marketing over the summer season of 2023. Flintshire Tourism Ambassador Scheme (part of the wider North Wales Ambassador Scheme) launched bronze and silver award modules in July and a organised heritage themed Learning Journey with Flintshire Tourism Association and Denbighshire County Council, which was attended by 35 businesses. A tourism sector bed stock audit and survey has been completed providing an up to date picture of the current levels and types of visitor accommodation in Flintshire. Two successful Shared Prosperity Fund bids have also been confirmed; Project 1 - (£353,540) a Council project which will provide improved connectivity to the coast and countryside, including improving the visibility of county boundary signs and network of tourist signs. Project 2 - (£639,000) a partner agency project, which will support tourism businesses with a grant key fund.



Action	Percentage Complete	RAG	Comment
Support small and/or local businesses to engage with public sector procurement opportunities	50%	★	Business Development is working with Robertson Construction (Mynydd Isa School development), Read Construction (Flint Primary School development) and Gilbert Ash (Theatr Clwyd development) to support local supply chain engagement through delivery of virtual 'Meet the Buyer' sessions, develop corporate social responsibility activities and encourage added social value commitments from Tier One and Tier Two contractors.

Tudalen 94

# Transport Connectivity

Action	Percentage Complete	RAG	Comment
Review and update the Councils Integrated Transport Strategy	50%	★	Following the publication of Welsh Government's New Wales Transport Plan, we are in the process of reviewing our own Integrated Transport Strategy. Once complete, this will form the basis of Flintshire's forthcoming Regional Transport Plan submission which will be undertaken by a North Wales Corporate Joint Committee (CJC). Local Member Workshops undertaken in October 2023 for which feedback from Members will be analysed and incorporated within our revised strategy and formal response to RTP consultation.
Support the establishment of CJCs and delivery of the Joint Regional Transport Plan	50%	●	we are in the process of reviewing our own Integrated Transport Strategy. Once complete, this will form the basis of Flintshire's forthcoming Regional Transport Plan submission which will be undertaken by a North Wales Corporate Joint Committee (CJC). Feedback from local Members will be incorporated within our revised strategy and formal response to RTP consultation.

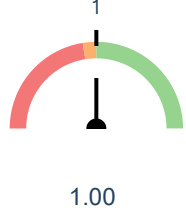
Transport Connectivity

Measure	Measure Description	Actual	Target	Last Year	Performance	Performance Trend
CST008M	Number of schemes delivered through the Welsh Government Active Travel Fund	1.00	1.00	1.00		
The Hope to Penyffordd and Broughton to Saltney scheme has been delivered						

Tudalen 96



# Digital Infrastructure

Action	Percentage Complete	RAG	Comment
Improve digital connectivity across the County for businesses and residents	50%	●	The main regional Growth Deal projects are developing their Green Book business cases and are on schedule. Major investment in fibre broadband infrastructure by BT Openreach in Flintshire means that over 70% of properties now have access to the fastest broadband options. New investment programmes from UK Government to invest in domestic broadband and fibre infrastructure have been announced and are being tendered currently. Further work is needed regionally and locally to encourage and facilitate private sector investment. The newly created Digital Connectivity role has yet to be successfully recruited, which is limiting capacity to move this agenda forward.

# Local Development Plan (LDP) Targets

Action	Percentage Complete	RAG	Comment
Maintain and update the Local Development Plan (LDP) Housing Trajectory in line with planning decisions made	50%	★	The updating of the housing trajectory will form an important part of the first Annual Monitoring Report to be submitted to Welsh Government by 31st October 2024. Work on monitoring housing land is undertaken each April and will feed into the trajectory.
Make decisions at Planning Committee in line with the adopted Local Development Plan (LDP)	100%	★	Policies in the adopted LDP have been consistently applied in both Planning Committee and delegated decisions on planning applications.
Monitor overall Plan performance via the Annual Monitoring Report (AMR) and submit to Welsh Government	50%	★	Following the adoption of the Local Development Plan in January 2023, the first Annual Monitoring Report (AMR) will need to reflect the first full 12 month period after adoption. The AMR will have a base date of 1st April 2024 and must be submitted to Welsh Government by 31st October 2024. Initial work on producing a draft report is underway.
Reference the LDP growth strategy in early work on a North Wales Strategic Development Plan (SDP)	10%	▲	Work is commencing on scoping out the preparation of a Strategic Development Plan (SDP) for North Wales. The growth strategy of the Local Development Plan will provide up to date planning context for the SDP.

Page 98

Local Development Plan (LDP) Targets

Measure	Measure Description	Actual	Target	Last Year	Performance	Performance Trend
CPE041M	Percentage of decision made on planning applications in accordance with officer recommendation	99.00%	100.00%		 <p>99.00%</p>	

The vast majority of planning applications are determined in line with officer recommendations with the exception of an occasional planning committee decision where officer recommendation overturned.

# Reducing Worklessness

Action	Percentage Complete	RAG	Comment
Co-ordinate a multi-agency approach to support businesses to recruit people from disadvantaged groups	50%	●	<p>During quarter two there has been a focus on supporting young people who will be leaving education and are unsure about what to do next. 'School Leavers' roadshows were held in Holywell, Mold and Broughton during the summer holidays offering advice and guidance about apprenticeships, job opportunities and entering the world of work. Our attendance at Coleg Cambria's Freshers Fairs was also an opportunity to let people know about the programme which might not just benefit them but also family members or friends.</p> <p>Two rounds of construction skills training took place during quarter two. Demand for training in this sector has been high with participants completing their Health and Safety Level One in construction qualification before going on to take their Construction Skills Certification Scheme test. A positive collaboration between Robertsons and Gilbert Ash construction employers has been in development, with opportunities for work experience and future employment in development. Communities For Work Plus also supported Wilmott Dixon at their Employment and Skills Fair during September 2023, as they will be constructing the new 56 bed care home in Flint (which will replace the existing Croes Atti facility) starting at the end of 2023.</p>
Deliver mentoring and wider support programmes to assist disadvantaged people to re-engage with the labour market	55%	●	<p>In quarter two a further 72 participants registered on the Communities For Work Plus programme, bringing the total to date of 216 participants. Referrals received from outreach employment events, 'Work Wednesday' employment drop in at Flint Library, internal departments within the Council, Job Centre Plus, Working Wales and self referrals.</p>

Tudor 100

## Reducing Worklessness

Measure	Measure Description	Actual	Target	Last Year	Performance	Performance Trend
CPE012M	Number of individuals entering employment, learning or volunteering	90.00	92.00	63.00		
<p>The number of individuals entering employment, learning and volunteering is again on target for quarter two. Individuals have gained work in the manufacturing industry including roles at Vauxhall and Ifor Williams, along with success in catering, hospitality and retail which is thriving with vacancies at the moment. Successful completion of learning opportunities have continued via our online e-learning portal including qualifications in Safeguarding, customer services and autism awareness along with a number of clients completing their Security industry Level Two qualification required for working in this sector.</p>						
CPE013M	Number of individuals receiving support	216.00	212.00	123.00		
Tudalen 101	<p>Mentors have engaged with their participants to provide on-going employability support to move them closer to the labour market and into successful employment. Mentors assigned with new participants have obtained relevant ID requirements to join the programme and completed assessments to produce an action plan to support individuals on their journey. Training has been obtained based on individuals learning needs.</p>					

# Personal and Community Well-being

# Personal and Community Well-being Overall Performance

## Personal and Community Well-being - Action RAG Status

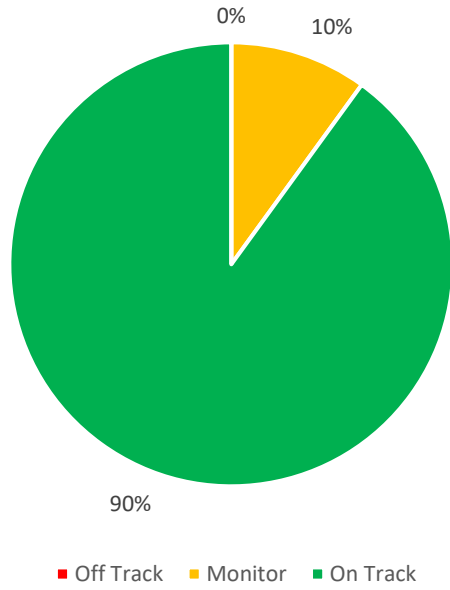

## Personal and Community Well-being - Measure RAG Status

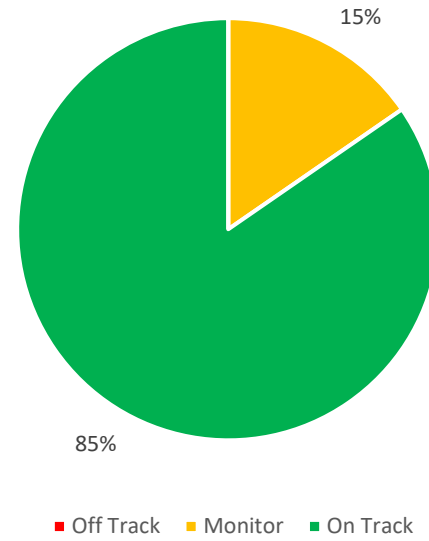

Tudalen 103

# Independent Living

Action	Percentage Complete	RAG	Comment
Complete a review of Community Mental Health provision and define a model for the future	50%	★	A workload analysis has been completed and a report has been submitted to the Community Mental Health Team (CMHT). We are now working on establishing an improvement action plan.
Continue to grow the Microcare market, including access to commissioned care packages	50%	★	There have been an additional 7 Micro-Carers setup during this financial year, with the foundational economy target of 10 expected to be surpassed by the end of 2023/24 (Quarter 4). This has grown the number of active Micro-Carers to 38. We have directly commissioned with 3 Micro-Care providers this year for personal care services, and 4 for well-being services.
Develop a national, regional and local approach to Early Years Transformation so that all our children ages 0-7 have the best possible start in life and are able to reach their full potential	75%	★	The draft Strategy is being presented to the Early Years Partnership in October 2023, prior to launch and publication. Work within the Strategy is on-going, and the Strategy formalises the approach and Action Plan based on four workstreams adopted by the Welsh Government. The Strategy requires collaboration and partnership working across the whole Early Years system to ensure effective outcomes for all children and longer-term health and wellbeing outcomes.
Plan for the relocation of Tri Ffordd supported employment project to Maes Gwern in Mold	50%	★	Design development for the Maes Gwern site has progressed throughout the year and the RIBA Stage 4 design is virtually complete and all necessary planning consents have been realised. The design concept has evolved to also incorporate health spaces at the site to create an integrated social services and health hub. The business case for Welsh Government Integration and Rebalancing Care Fund (IRCF) funding has been progressed and the application for the project was reconsidered and reviewed by the IRCF Panel in September 2023, following an initial presentation to the panel in July 2023.
Provide additional placements for step down care within our in-house provision (Croes Atti 2)	50%	★	The Council has approved a final design for a new 56 bedroom residential care home in Flint, on the site which previously housed the Flint Cottage Hospital. This facility will offer residential care of the highest quality with state of the art facilities across 4 floors. One of these floors will be dedicated to providing Discharge to Recover and Assess support to approximately 12 residents at any one time, providing short term care that supports the reablement and recovery of residents following a period in hospital or other identified needs. This approach has been demonstrated to reduce or even remove the need for care packages upon their return home and sustains independence. We anticipate that this facility will be complete and operational by April 2025.
Support people to achieve their mental well-being outcomes by promoting personal and community well-being through open access courses delivered by the Learning Partnership	50%	★	We continue to promote personal and community well-being through the Learning Partnership. In the first half of this year, 22 Open Access courses were delivered to 160 individuals.



Action	Percentage Complete	RAG	Comment
Utilise the progression model as a way of promoting people's independence skills	50%	★	The Progression Service currently supports 63 individuals using the Progression Model of Support to ensure people have increased independence, autonomy and control in their lives. The fundamental factors in achieving this relate to the social work teams ability to build relationships, promote positive risk taking, work together with the individuals to ensure strengths based, person centred, holistic and creative support is at the forefront in all we do. We address resistance from carers and family members in helping the individual achieve optimum independence, utilising the knowledge of the person and each other. By using tools such as communication profiles and aids, training, SMART goals and bench marking skills assessments we ensure each person that is referred to the team is made aware of their own strengths and how they can help themselves, what their friends and family can do, what is available in the community and how other professionals as well as assistive technology can help. We have reduced paid support by approximately 25% as a result. Progression Service are working closely with Learning and Physical Disability Teams to ensure Progression is embedded across adult disability services for both new referrals and current open cases.
Work in partnership with the Community Mental Health Team and Social Services Mental Health Support Service to develop clear pathways for individuals needing access to Mental Health Services, and a sustainable model for the future	50%	★	A workload analysis has been completed and a report has been submitted to the Community Mental Health Team (CMHT). We are now working on establishing an improvement action plan.
Work with Housing to fund a small team of people to support individuals with low level mental health problems to improve their housing	50%	★	A Wellbeing and Recovery Accommodation Service was set up in partnership with Housing in September 2023, including one Social Worker and two support workers.

T: 01453 105

## Independent Living

Measure	Measure Description	Actual	Target	Last Year	Performance	Performance Trend
CSS003M	Direct Payments as a % of home-based services	42.90%	40.00%	41.00%	<p>42.90%</p>	
<p>Whilst the overall figure is positive, the percentage is heavily influenced by service areas who are almost exclusively utilising direct payments. The following details the percentage take up of direct payments for each service area; Disabilities 67.9%, Mental Health 82.6%, Vulnerable Adults 100%, Children 98.3%, Adult Carers 100%, Substance Misuse 100%, and Older People 12.7%. Further work needs to be done to improve opportunities for more older people to self determine their care and support solutions via a direct payment.</p>						
CSS004M	Percentage of urgent requests for equipment that meet or exceed the national 1 Day response standards	100.00%	98.00%	100.00%	<p>100.00%</p>	
<p>A total of 5,165 items have been delivered within 1 working day for the second quarter. The North East Wales Community Equipment Service continues to meet the standard set by Welsh Government.</p>						
CSS005M	Percentage of requests for equipment that meet or exceed the national 7 Day standard	100.00%	80.00%	100.00%	<p>100.00%</p>	
<p>A total of 10,051 Items have been delivered within the 7 day delivery standard set out by Welsh Government. The Community Equipment Service currently operate 20% over the standard.</p>						

Tiddalen 106

Measure	Measure Description	Actual	Target	Last Year	Performance	Performance Trend
CSS006M	Percentage of equipment that is re-used	95.00%	70.00%	93.00%	<p>70 95.00%</p>	
<p>The North East Wales Community Equipment Service is currently maintaining an Equipment Re-use percentage of 95% for quarter 2. This has equated to a total cost avoidance for the quarter of £598,513, this results in a £1,146,095 cost avoidance for the year thus far.</p>						
CSS007M	Number of courses delivered by the Learning Partnership	22.00	22.00		<p>22 22.00</p>	
<p>22 Open Access courses were delivered between April and September 2023.</p>						
CSS008M	Number of attendees for courses delivered by the Learning Partnership	160.00	160.00		<p>160 160.00</p>	
<p>160 individuals attended Open Access courses between April and September 2023.</p>						



Tudalen 107

# Safeguarding

Action	Percentage Complete	RAG	Comment
Prepare for the implementation of the new Liberty Protect Safeguard procedures	100%	★	The UK Government have announced that they do not intend to bring forward the necessary legislation to implement the Liberty Protection Safeguards (the LPS) within this Parliament. This means that Welsh Government cannot bring forward its own regulations to implement the LPS in Wales. Despite this decision, the Welsh Government has confirmed that it remains committed to providing funding to protect the rights of those who lack mental capacity under the current Deprivation of Liberty Safeguards (DoLS) system to ensure that that these rights are protected ahead of any future implementation of the LPS.
Promote the corporate e-learning package	40%	●	Between 1 April – 30 September 2023, 886 Social Services staff completed the corporate e-learning safeguarding module, equivalent to 76% of the workforce. We also delivered 5 safeguarding training sessions to 63 staff working for Independent and voluntary sector agencies. The All-Wales e-learning module available via the Corporate Learning Pool and Social Care Wales website continues to be widely and regularly promoted.

## Safeguarding

Measure	Measure Description	Actual	Target	Last Year	Performance	Performance Trend
CSS009M	Percentage of adult safeguarding enquiries that met the 7 day timescale	84.00%	92.00%	98.00%	<p>84.00%</p>	
<p>Between April and September 2023, 536 safeguarding reports for adults have been received. Of the reports that resulted in Section 126 enquiries being undertaken, 84% of these enquiries met the national timescale. This is below our target, due to the significant increase in demand, when compared to 407 in the same period the previous year. The Safeguarding Unit continue to prioritise safeguarding reports on an individual basis.</p>						
CSS010M	Percentage of reviews of children on the Child Protection Register due in the year that were carried out within the statutory timescales	98.10%	99.00%		<p>98.10%</p>	
Tudalen 109	<p>237 reviews of child protection plans have been completed between April and September 2023. 98% of these were completed within timescales.</p>					
CSS011M	Percentage of Pre-birth assessments completed within timescales	100.00%	96.00%		<p>100.00%</p>	
<p>Between April and September 2023, 29 risk assessments for unborn babies have been completed, all within timescales. Our resilience is being managed by an Agency Team to help ensure our Safeguarding Assessments are being completed within timescales.</p>						

Measure	Measure Description	Actual	Target	Last Year	Performance	Performance Trend
CSS012M	Percentage of children who were reported as having run away or gone missing from home who were offered a return interview	100.00%	100.00%	100.00%	 100.00%	

There were 140 episodes where children were reported missing from home, involving 40 children. All children were offered a return interview. We do have a number of young people who refused or didn't engage in the period. The majority of young people who go missing are known to Social Services.

Tudalen 110

# Direct Provision to Support People Closer to Home

Action	Percentage Complete	RAG	Comment
Continue to grow our in-house fostering service to support more looked after children	50%	★	The general carer recruitment is steady, with two new carers approved between April and September 2023. A further five connected person approvals have enabled children and young people to be placed with family as an alternative to foster care.
Continue to grow our in-house homecare service to support more people to live at home, utilising a rolling scheme of recruitment	40%	●	We have faced significant challenges in recruiting to our community-based teams. We are continuously reviewing our recruitment strategy for homecare and looking for alternative ways to advertise and encourage new applicants.
Deliver a programme of registered Children's Homes to help avoid the need for residential placements outside Flintshire	50%	★	We have 3 of the 5 new homes successfully registered with Care Inspectorate Wales (CIW). We continue to work with CIW around the registration process for one of the homes and we are working on the documentation in readiness for applying for registration for the other home. Within the service we are continuing to recruit to the roles and this is something that is a challenge in the current climate. We are working with 'We Care Wales' and local providers such as Job Centre Plus as well as in house teams and departments such as our HR partners. The work force continue to develop their skills and attend all learning and development opportunities available to them where possible.
Develop childcare expansion and seamless childcare provision across programs	50%	★	Phase Two of the Flying Start two year olds part time child care expansion is currently rolling out in Flintshire. Take up is satisfactory to the projection and 11 new childcare providers are registered to provide Flying Start childcare. The Early Years and Childcare Capital Phase Two work is currently in the status of "Starting up a project". Business justifications (bids) will be submitted to Welsh Government (WG) in the next four weeks to secure funding subject to Cabinet approval. Additionally, small capital funding also supports the development of seamless childcare provision across Flintshire to support the Childcare Offer, Early Entitlement, and Childcare and Play Funding. All of the work supports the Council's strategic objectives in line with the Welsh in Education Strategic Plan (WESP) and Childcare Sufficiency Assessment (CSA), and is fully funded by Welsh Government.
Explore the recommissioning of advocacy services on a regional basis	50%	★	The contract went out to tender in partnership with Wrexham County Borough Council. Responses have been received and providers have been interviewed. The evaluation was completed on 29th September 2023, with contract award reports submitted in the following week.
Increase skills around autism with respect to advocacy	50%	★	Training has been offered to Advocacy providers and included in future contracts. E learning is now available through the National Autism team.

# Local Dementia Strategy

Action	Percentage Complete	RAG	Comment
Establish a Dementia Strategy Implementation Group, to include representation from people with lived experience	50%	★	A Dementia Strategy Project Board was established in 2022 to implement the key actions identified in the Flintshire Dementia Strategy. The actions align with the implementation of the All Wales Dementia Care Pathway of Standards. The Project Board meets every two months and receives input and feedback from citizens by linking to the Dementia Friendly Community Chairs Group. The Board is currently overseeing the implementation of the new North Wales Dementia Friendly Community recognition scheme and the Dementia Listening Campaign.



Tudalen 112



# A Well-connected, Safe and Clean Local Environment

Action	Percentage Complete	RAG	Comment
Work in partnership, actively support and engage with community led groups by developing Local Environmental Quality initiatives	100%	★	There has been a significant amount of work and collaboration with internal and external partners and a lot of progress has been made in many of the communities across Flintshire. Fly tipping, dog fouling and littering Campaigns have been implemented and all have been successful in promoting the initiatives we are wanting to maintain.

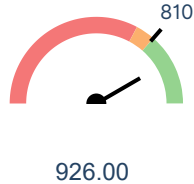
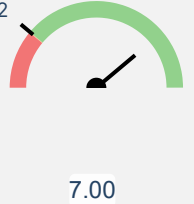
## A Well-connected, Safe and Clean Local Environment

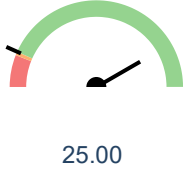
Measure	Measure Description	Actual	Target	Last Year	Performance	Performance Trend
CAU026M	Number of current monthly members with NERS, Well-Being and Junior subscriptions	926.00	810.00			
<p>Throughout the six-month period April-September, the National Exercise Referral Scheme (NERS) averaged 345 direct debit paying members per month, Well-Being (post-NERS exit membership) averaged 106 per month, and Junior (11-17 years) averaged 475 per month.</p>						
CST017M Tudalen 114	Number of targeted environmental educational campaigns undertaken promote improved Local Environmental Quality	7.00	2.00	3.00		
<p>Dog Fouling - Working collaboratively with KWT and Groundworks North Wales, we have engaged with scout groups, brownies and local schools to promote the Bag it Bin it campaign, with glow in the dark signage placed on dog bins to deter night time offenders. This supports our preventive approach and has demonstrated the effectiveness of the Public Space Protection Orders. The Green dog walking campaign has now been successfully launched with encouraging numbers of our dog walking community signing up. Educational Fly tipping events have been arranged for Flint, Bagillt and Buckley areas, these followed environmental audits which highlight environmental problems in the community. At least eight letter drops have taken place over the last six months in Flint, Connah's Quay, Buckley, and Pen y Ffordd targeting residents on environmental improvement initiatives.</p>						
CST022M	Number of community engagement events attended to promote improved Local Environmental Quality	25.00	4.00			
<p>At least eleven environmental audits have taken place in the last six months with local members. These have been requested across many of the towns in Flintshire and have related to Fly tipping. The audits have been in collaboration with FCC Housing, Area Co-ordinators, Community Groups, Volunteers, Schools and Housing Associations. Ongoing events and educational campaigns have been identified and are progressing. In the last six months at least nine community events have been attended and these include, Denbigh and Flint Show, Connah's Quay Festival, Higher Kinnerton Festival and 999 Day in Flint. We had a stand at each event and were able to pass on advise, leaflets etc alongside working with external and internal partners. We have been working with businesses regarding local litter picking days and at least three were carried out in June and July 2023. We have also had litter picking days with three schools in May and June 2023.</p>						

# Education and Skills

# Education and Skills Overall Performance

Education and Skills - Action RAG Status

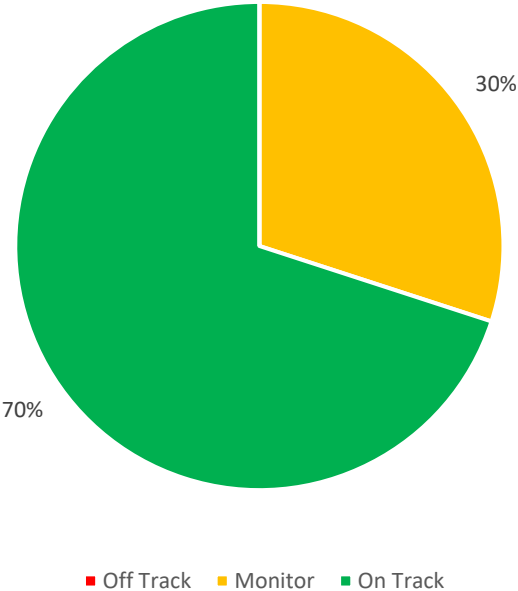

Tudalen 116

There are no quarterly measures within the Education and Skills Priority.

# Educational Engagement and Achievement

Action	Percentage Complete	RAG	Comment
Embed the revised processes and procedures in relation to attendance and exclusion, using data to better inform and target interventions at both a pupil and school level	50%	★	Processes have been established and are being embedded as a core part of the operational approach of the Education welfare Service (EWS). Attendance and exclusion information is now shared on a regular basis across the Inclusion and Progression Management Team. Supporting the attendance of pupils transitioning from Year 6 into secondary schools has been a focus for targeted intervention from the EWS.
Explore and develop options for in house provision in response to the increasing number of pupils struggling to engage with education due to mental health difficulties	40%	★	Work is underway to pilot a range of inhouse provisions. Teaching and support staff have been appointed and external providers are being sourced to support a broad curriculum offer.
Provide bespoke support for schools through training and development to improve the level of speech language and communication skills for pupils	80%	★	All primary schools have been offered access to training on the Talkboost programme to support pupil speech and language development. This is joint initiative delivered by officers and health's speech & language therapists. Multi-agency meetings have taken place to identify other suitable programmes of intervention and training for schools. Work has continued on supporting access for schools to a reporting tool to target and monitor the impact of intervention.
Support the implementation of the revised curriculum for secondary pupils in years 7 and 8	100%	✔	All secondary schools in Flintshire have implemented the revised curriculum for secondary pupils in Years 7 and 8 from September 2023. Each school continues to work with their supporting improvement adviser to embed this work. Schools can access ongoing professional development through the consortium.
Through the roll out of the Wales Government delivery model for Community Focused schools establish a collaborative approach to reduce school exclusion and improve school attendance	40%	★	Staff have been recruited to the management and family engagement roles. The teams are established within the designated delivery areas and are developing links with the schools and communities.

# Digital Learning Opportunities

Action	Percentage Complete	RAG	Comment
All schools to have a formally adopted Digital Strategy	30%	●	The pace of delivery for all schools to have a formally adopted Digital Strategy was impacted by the need to recruit to the post of a Digital Officer. September 2023, saw the successful recruitment of a Digital Officer.
Embed the delivery plan for Integrated Youth Services by maintaining focus on digital, school and community engagement	100%	★	This is embedded and the service continues to strive for increasing and improving the offer, including further utilising digital options to further the reach of the service.

Tudalen 118

# Learning Environments

Action	Percentage Complete	RAG	Comment
Commence construction of the Drury CP refurbishment and extension	0%	★	Construction not yet commenced as project is currently in the design development stage.
Commence design development options for a new Welsh medium primary school for Buckley / Mynydd Isa area	25%	●	Project is at early planning and scoping stage - Strategic discussions also underway with the Welsh Government Sustainable Learning Communities Capital Investment Team.
Complete construction of the Penyffordd CP extension	50%	★	Construction of the Penyffordd CP extensions have commenced and remain on programme, on time and within budget.
Continue construction of the 3-16 campus at Mynydd Isa	50%	★	Construction of new 3-16 campus commenced in November 2022 on the Argoed High School site. Progress continues in line with the construction programme and Phase 1 of the campus is on target to be delivered as expected and within the parameters of the contract for the project.
Determine a strategy for school modernisation within the Saltney area	10%	●	An early engagement process was completed in July to understand the schools' and community views.
Progress the development of a new premises plan for the North-East Wales Archive	30%	●	As joint partner, Denbighshire County Council have continued to review plans and options available pending their formal approval process.
Schedule Council approval to progress Wales Government's Band B Sustainable Communities projects within the Learning Investment Programme	50%	★	The Sustainable Communities for Learning Programme is designed to be delivered over a number of waves, or 'bands' of investment, currently in Band B (2019-2024) the Council has agreed with Welsh Government a total investment of circa £85 million. Three projects identified within Band B have been delivered, four are currently progressing, one is at initial scoping phase, two at design development and one is currently in construction.



# Learning Community Networks

Action	Percentage Complete	RAG	Comment
Continue to consolidate the joint working between Flintshire County Council and Denbighshire County Council through the Northeast Wales Archive to provide a sustainable and resilient service	30%	●	The joint service between Flintshire and Denbighshire County Council is firmly established in accordance with its Memorandum of Understanding. Further development of the working arrangements has focused on the operational mergers of budgets, HR and IT services, some of which can only be fully operationalised once the new build is in place.

Tudalen 120



# Welsh Education Strategic Plan (WESP)

Action	Percentage Complete	RAG	Comment
Complete the strategic actions for Year 1 of the WESP 5-year action plan	100%		All actions were given a RAG rating and discussed at the summer term meeting of the Welsh in Education Forum. No actions were identified as red and the annual report was submitted to Welsh Government in July 2023. The Forum has now moved to implementing year two of the five year action plan.
Extend the range of youth services delivered bilingually to encourage young people to retain and use their Welsh language skills into early adulthood	50%		This continues with the URDD Gobaith Cymru taking the lead until there is recruitment for a Welsh language Youth Worker. The sessions have been taking place in schools during quarter one and quarter two.
Review Welsh medium resource provision for pupils with Additional Learning Needs	75%		The Senior Learning Advisor, Additional Learning Needs, Inclusion and Progression teams have visited all Welsh medium schools to review the current Welsh Medium provision and support for children with additional learning needs.

# Well-being

Action	Percentage Complete	RAG	Comment
Embed a Whole School Approach to Emotional Health and Well-being in all Flintshire	70%	★	This work is on track with 73% of all Flintshire schools actively engaged in this process.
Improve awareness of trauma informed practice with schools and Education and Youth employees	50%	★	The 'Belonging' group has been established with senior leaders in high schools and key officers to advance and improve awareness of a trauma informed practice. The initial meeting of the group being held in the Summer Term. The Trauma Informed Schools UK (TISUK), eleven day diploma training has commenced with 24 key school leads and officers taking part. TISUK have also delivered a whole setting awareness training to two schools.

Tudalen 122

# A Well Managed Council

# A Well Managed Council Overall Performance

Tudalen 124

### A Well Managed Council - Action RAG Status

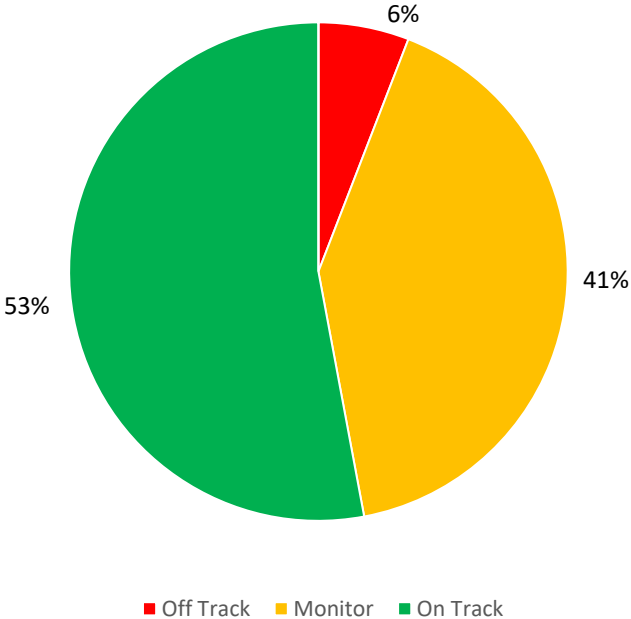

### A Well Managed Council - Measure RAG Status

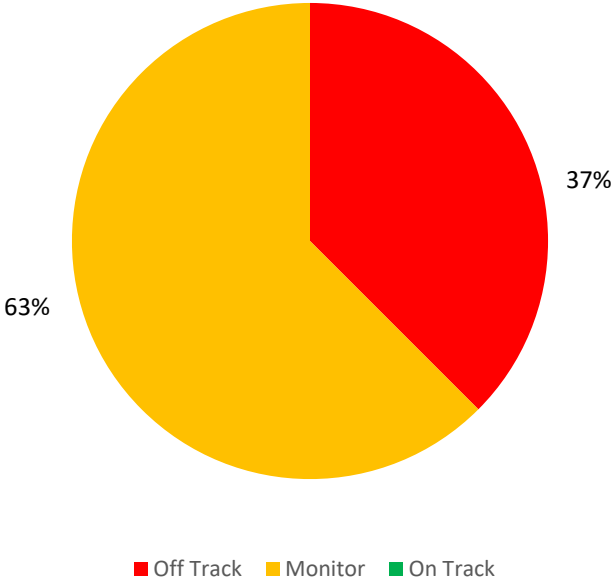

# People

Action	Percentage Complete	RAG	Comment
Implement a compliant and sustainable new pay model	50%	●	<p>The current pay model has not been reviewed since 2019 (which was implemented to accommodate changes to the nationally agreed pay model). Increases in the National Living Wage over the last few years in addition to known/anticipated changes which continue to erode the bottom of the existing pay structure.</p> <p>A joint planning group with Trade Unions have met several times to progress what is a complex piece of work, which is ongoing. Discussions are progressing positively, and we are optimistic of achieving an agreed variation to our current collective agreement and create a new pay model, for employees on Green Book Terms and Conditions. We do not anticipate anyone being in pay detriment.</p>

People

Measure	Measure Description	Actual	Target	Last Year	Performance	Performance Trend
CHR001M	The number of working days lost per full time equivalent (FTE) local authority employees lost due to sickness absence	4.59	4.50	5.41	<p>4.59</p>	

The mid-year cumulative full time equivalent (FTE) days lost for 2023/24 is 4.59, which is an improvement when compared to the previous year (5.41). The Council continues to work closely in managing attendance, offering additional support, including mindfulness, counselling, stress management courses, stress risk assessments etc. Additional support is also available from Vivup (Vivup replaced CareFirst).

CHR004M	Percentage of employees who have completed all of mandatory modules	39.40%	100.00%		<p>39.40%</p>	
---------	---	--------	---------	--	---------------	--

The overall completion rate at mid-year is 39.40%. Managers receive monthly progress reports for their teams to ensure that the training has been completed. Workshops and group sessions are coordinated to accommodate work groups who do not have I.T access, such as Streetscene Operatives and school based employees.

Tudalen 126

# Anti-Racist and Anti-Discriminatory Council

Action	Percentage Complete	RAG	Comment
Complete a Portfolio annual self-assessment against the Welsh language standards and implement action plan to improve - Education and Youth	75%	★	The annual self-assessment against the standards has focused on the use of telephones, website and social media. Most assessments have been completed and action plans have been developed to ensure compliance.
Complete a Portfolio annual self-assessment against the Welsh language standards and implement action plan to improve - Governance	75%	★	The self assessment is complete. The Governance portfolio is working alongside the Welsh Language Policy to develop an action plan to improving telephone call handling, this is due to be submitted to the Welsh Language Commissioner.
Complete a Portfolio annual self-assessment against the Welsh language standards and implement action plan to improve - Housing and Communities	75%	★	The self assessment and action plan to improve services for the Portfolio have been completed.
Complete a Portfolio annual self-assessment against the Welsh language standards and implement action plan to improve - Planning, Environment and Economy	90%	★	The self assessment is now complete and an action plan has been put in place. There are four outstanding actions from the action plan left to implement: 1) Issue a reminder instruction to all officers regarding Welsh Language greeting and not treating any less favourably than English, 2) Issue instruction to officers to comply with Standard 19, 3) Re-check those pages identified in the initial audit of webpages identified as non-compliant, and 4) Check use of social media by service areas and how they communicate in Welsh.
Complete a Portfolio annual self-assessment against the Welsh language standards and implement action plan to improve - Social Services	100%	✔	Annual self-assessment against the Welsh Language Standards is complete and an action plan to improve was implemented in April 2023.
Complete a Portfolio annual self-assessment against the Welsh language standards and implement action plan to improve - Streetscene and Transportation	25%	★	The self assessment is currently underway, we are sampling documents and forms used by the service and the replies to external phone calls.
Complete a Portfolio annual self-assessment against the Welsh language standards and implement action plan to improve - Chief Executives	50%	★	The self-assessments against the Welsh Language Standards for Corporate Services have now been completed. An Action Plan to improve remains to be completed.

Anti-Racist and Anti-Discriminatory Council

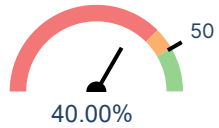
Measure	Measure Description	Actual	Target	Last Year	Performance	Performance Trend
CPA001M	Strategic Equality Action Plan in place and actions achieved	40.00%	50.00%		 <p>A gauge chart with a semi-circular arc. The arc is divided into three segments: red (0-40%), orange (40-50%), and green (50-100%). A needle points to the 40% mark. The number '40.00%' is written below the needle, and '50' is written at the end of the orange segment.</p>	

Percentage refers to the development of the Strategic equality Plan for 2024/28 and the implementation of the actions. The target for 2023/24 was to develop and publish the SEP 2024-28 by the end of the financial year. Engagement and consultation has taken place with stakeholders to inform the draft Strategic Equality Plan. The draft Plan is now ready and will be going to Informal Cabinet before wider consultation. Implementation of the actions won't start to take place until April 2024 onwards.

Tudalen 128



# Financial Resilience

Action	Percentage Complete	RAG	Comment
Ensure an adequate level of reserves is maintained by the Council	50%	●	Reserves are monitored on a quarterly basis as part of the revenue budget monitoring. A review of earmarked reserves is being concluded which will recommend some are transferred to the general reserve.
Ensure robust processes exist for the management and recovery of debt including Council Tax and rent	50%	★	We continue to take recovery action in appropriate cases, especially where taxpayers fail to meet their payment obligations and fail to engage with the Council. The Corporate Debt Recovery Policy has also been reviewed to strengthen the recovery processes for non-payment of housing rent
Ensure that robust monitoring arrangements are in place for revenue and capital	50%	★	Revenue budget monitoring takes place monthly and Capital monitoring quarterly. Reported to Cabinet and to Scrutiny.
Ensure the funding needs of the Council over the medium term are met through financial planning	50%	●	A Report to Cabinet has identified an additional budget requirement of £32m for 2024/25. Work is underway to identify solutions to meet this to achieve a legal and balanced budget in February 2024.

Tudalen 129

# Flintshire Assets

Action	Percentage Complete	RAG	Comment
Commercial Estate Rent Review	20%	●	Rents have been independently reviewed. Legal to draft notices to tenants. Implementation will be on a phased basis across the three estates - Dock Road, Pinfold and Garden City industrial estates.
Form and agree Office Accommodation Strategy	10%	●	Collation of information from services is underway. Space planning is due to commence to understand the accommodation requirements for staff in County Hall to enable the mapping against other office buildings.
Review of Industrial Estate Strategy (Area by Area)	10%	▲	Reviews have taken place in Castle Park and Greenfield as part of the Levelling Up Fund (LUF) bid. Options are currently being reviewed.

Tudalen 130

# Digital

Action	Percentage Complete	RAG	Comment
Continue to promote My Account as an access channel to access the Council and its services	50%		My Account is promoted through various channels e.g. email signatures, e-bulletins, website, Digital Hub. The Council is continually looking for opportunities to promote its use with a desire to increase uptake by our contract holders.

Digital

Measure	Measure Description	Actual	Target	Last Year	Performance	Performance Trend
CGV003M	Number of My Account subscriptions.	33,575.00	30,800.00	27,068.00		
<p>The number of subscriptions to 'My Account' continues to increase each quarter. There is a lower take-up from contract holders who have the option to link their tenancy with My Account, only 254 contract holders have done so.</p>						
CGV008M	80% of telephone calls to the corporate Contact Centre answered	68.00%	80.00%			
<p>In the first half of 2023-24 the corporate Contact Centre were presented with 88,384 telephone calls, 68% were answered. The service deals with a wide range of telephone calls including two areas that generate the highest volume of customer contact - Streetscene (35,944) and Housing (34,272), Planning, Elections, Blue Badges and Switchboard. The best performing area is Streetscene with 73% of calls answered. Whilst falling short on its target, the corporate Contact Centre has faced significant staff challenges this year with several vacant posts and sickness which inevitably impact performance and how quickly telephone calls can be answered within the limited resources available.</p>						
CGV009M	70% of Step 1 complaints against Council services are dealt with within 10 working days	75.67%	70.00%			

Tudalen 122

Measure	Measure Description	Actual	Target	Last Year	Performance	Performance Trend
CGV010M	Number of unique website views	638,000.00	500,000.00			
<p>The Council's website provides a wide range of information and access to Council services. Between April and September 2023, the website has been used over 638,000 times with over 1.7m page views.</p>						
CGV011M	Number of eforms submitted to the Council	92,417.00	26,500.00			
<p>The Council continues to provide a wide range of online forms to enable customers to transact with services digitally.</p>						

Tudalen 133

# Partnerships

Action	Percentage Complete	RAG	Comment
Deliver three engagement events to encourage other organisations to sign up to the Armed Forces Covenant , which contribute to Flintshire County Council being re-accredited with the Defence Employers Recognition Scheme Gold Award in 2024.	33%		One event was held on 6th June 2023, hosted by the Business Team. Additional organisations have been contacted to encourage them to sign up to the Armed Forces Covenant, including the Veteran's Hub.

Tudalen 134

# Eitem ar gyfer y Rhaglen 6



## CABINET

<b>Date of Meeting</b>	Tuesday, 16 <sup>th</sup> January 2024
<b>Report Subject</b>	Updated Contaminated Land Inspection Strategy
<b>Cabinet Member</b>	Cabinet Member for Planning, Public Health and Public Protection
<b>Report Author</b>	Chief Officer (Planning, Environment & Economy)
<b>Type of Report</b>	Strategic

### EXECUTIVE SUMMARY

On 1st July 2001, legislation requiring land contamination to be inspected and addressed was enacted in Wales. The legislation is known as Part 2A of the Environmental Protection Act 1990 and it introduced a detailed way by which land contamination should be regulated. It charges each Local Authority with a statutory duty to identify and inspect land where there are reasonable grounds to suspect that land to be affected by contamination. It also requires Local Authorities to secure the remediation of land contamination where necessary.

This statutory duty is imposed regardless of the ownership of the land.

The Contaminated Land Inspection Strategy describes how Flintshire County Council is required by Part 2A of the Environmental Protection Act 1990 to identify and inspect land within its administrative control and explains the steps that the Council will take to investigate the land to secure the remediation of contamination.

Flintshire County Council's Contaminated Land Inspection Strategy has been updated in 2023 to reflect current Council policies, objectives and the replacement of a principal piece of regulatory guidance relating to the assessment of land contamination.

This report explains the purpose of the Strategy and the updates made.

## RECOMMENDATIONS

1	That Members endorse the updates to the Contaminated Land Inspection Strategy.
---	--

## REPORT DETAILS

1.00	CONTAMINATED LAND INSPECTION STRATEGY
1.01	Flintshire County Council has a statutory duty to identify and inspect any land within Flintshire where there is reasonable ground to suspect that land to be affected by contamination and to secure the remediation of Contaminated Land in accordance with Part 2A of the Environmental Protection Act 1990.
1.02	The principal activities of the contaminated land function are to discharge the Council's statutory duty in accordance with Part 2A of the Environmental Protection Act 1990, to publish and implement a Contaminated Land Inspection Strategy and to support the Council's Planning Service to secure, through enforcement where necessary, the assessment and remediation of land contamination across Flintshire.
1.03	In addition to enforcement and regulatory responsibilities, the Contaminated Land Function provides advice and information to individuals, residents, developers, and businesses to make them aware of their rights and obligations and to enable them to improve and safeguard public health and the natural and built environments across Flintshire.
1.04	The Contaminated Land Inspection Strategy has a clear aim to promote, support and complement legislative requirements, UK Government, Welsh Government and the Council's own policies and priorities to protect and improve public health and the environment.
1.05	The implementation of the Strategy has been progressing through a programme of inspections and many sites have either been assessed or have been identified for assessment.
1.06	A principal regulatory guidance document relating to how land contamination assessments are expected to be carried out has been withdrawn. It is expected that the Council, as primary regulator for Part 2A of the Environmental Protection Act 1990, adheres to the same regulatory guidance as the commercial sector when undertaking assessments.
1.07	The Contaminated Land Inspection Strategy has been updated to remove references to the withdrawn guidance and to include reference to the new guidance.
1.08	A summary of the changes made to the document can be found in the table below:



2017 Version	2023 Version
Page 2	Update address to Ty Dewi Sant
Page 2	Update portfolio name
Page 3	Change 'investigations' to 'assessments'
Page 3 (and Pages 49, 50, 51, 52 & 54)	Update terminology relating to stages of assessment - 'desk study' to 'preliminary risk assessment' and 'intrusive investigation' to 'detailed risk assessment'.
Page 3	Amend text to align references to stages of assessment.
Page 3	Update terminology – replace 'remove or reduce those risks to acceptable level' with 'address those risks'.
Page 5	Update terminology – replace 'investigate' with 'inspect' or 'assess'
Page 6	Add bullet point 'To enhance and protect the natural environment and biodiversity'
Page 6	Add bullet point 'To take account of the effect of climate change on the lifespan of remediation measures'
Page 6	Update bullet point with references to current corporate plans and policies. Remove outdated and replace with current.
Page 6	Update terminology. Replace 'investigate' with assess.
Page 7	Add 'where there is reasonable ground to suspect' to 4.1.
Page 7 (and Pages 35, 37, 40 & 41)	Update terminology – change Contaminated Land Strategy to Contaminated Land Inspection Strategy.
Page 8 (and Pages 41 & 42)	Clarify purpose of Public Register – add 'specific' to 'actions'.
Page 8 (and Page 40)	Add reference to (Part 2A of) Environmental Protection Act 1990 in 5.0

Page 8	Add 'professionally accredited'
Page 14	Update references to corporate plans and policies. Replace outdated with current in 6.0
Page 14 (and Pages 38 & 43)	Update terminology – replace 'investigate/investigated' with 'assess/assessed'.
Page 15	Update portfolio name on map legend (FCC N Wales context map)
Page 21	Include reference to NRW
Page 21	Add reference to new legislation – 'Conservation of Habitats and Species Regulations as the many of the designated environmental conservation sites including the River Dee, are sensitive to the presence of phosphates'.
Page 22	Amend reference – replace 'Environment Agency' with NRW
Page 23	Updated figures for numbers of listed buildings, historical landscapes, scheduled ancient monuments and conservation areas.
Page 31	7.10.8 removed text 'The wings....by sea'.
Page 32	Updated reference to Deeside Industrial Park to reflect Northern Gateway development in 7.11
Page 33	Updated figures to reflect number of planning applications and number of sites assessed through Part 2A.
Page 34 (and Pages 38, 39 & 41)	Updated portfolio name.
Page 55	Removed Table 3 – timescales neither applicable nor relevant to on-going work or required by Statutory Guidance.
Appendix 1	Updated addresses to Ty Dewi Sant
Appendix 2	Updated list of basic references

1.09	As outlined in paragraph 1.08, the changes to the document are not extensive, but reflect organisational changes and amended guidance during the intervening period.
------	--

<b>2.00</b>	<b>RESOURCE IMPLICATIONS</b>
2.01	Flintshire County Council has an annual revenue budget to fund the assessments which is held within the portfolio budget. In addition to this, the Planning, Environment and Economy Portfolio employs a specialist Contaminated Land Officer (full-time) to lead on and deal with land contamination related work, projects and programmes of work. The Contaminated Land Officer also supports the work of the wider Planning, Environment and Economy Portfolio.
2.02	Capital funding set aside by Welsh Government from a capital programme, is currently suspended as that programme undergoes a review.
2.03	The continued progression of the Contaminated Land Inspection Strategy ensures that Flintshire is in a strong position to apply for funding. Competitive applications for funding will continue to be made when the Welsh Government restore their capital programme.
2.04	One of the key objectives of the Strategy is to minimise the unnecessary burden of cost to the taxpayer, business, and individuals.
2.05	The 'Polluter Pays' principle applies to Part 2A of the Environmental Protection Act 1990, and the responsibility for land contamination rests with those who caused or knowingly permitted it or, with the owner or occupier of the land. The Council will make reasonable enquiries to identify and trace those responsible for the contamination and for each individual link between contamination and receptor and will offer them an opportunity to carry out remedial works voluntarily.
2.06	Where the works cannot be secured voluntarily, appropriate enforcement action will be taken.

<b>3.00</b>	<b>CONSULTATIONS REQUIRED / CARRIED OUT</b>
3.01	Formal consultation is not required for non-material changes to the Contaminated Land Inspection Strategy. However, consultation on this latest version has been undertaken with all Members, Town and Community Councils and Welsh Government, and has also been shared with all Chief Officers and the Welsh Land Contamination Working Group. This Group comprises of technical specialists from across Wales, including Natural Resources Wales. The Strategy was also shared with the Welsh Land Contamination Working Group. This consultation period was 21 July 2013 to 15 September 2023. No adverse comments were received.

3.02	<p>Before seeking Cabinet approval, the Inspection Strategy has been considered by Environment &amp; Economy Overview and Scrutiny Committee on 19<sup>th</sup> December 2023.</p> <p>Comment was received that Members did not wish reference to the historical manufacture and transport of the Airbus A380 wings in Section 7.10.8 (page 31). An additional amendment to the document has therefore been made and this point removed.</p>
------	--

<b>4.00</b>	<b>RISK MANAGEMENT</b>
-------------	------------------------

4.01	Flintshire County Council has a statutory duty under Part 2A to identify, assess and secure the remediation of contaminated land.
4.02	Both private and public land is included, along with any land that the Council may own itself. The Council also has a responsibility to ensure that the Council’s assets and liabilities and any legacy obligations from activities which took place in the past, are appropriately assessed from due diligence and environmental liability perspectives.
4.03	The assessment and remediation of land affected by contamination ensures that public health and the environment are protected, that land is brought back into beneficial use.
4.04	Addressing land contamination transforms the natural environment and by turning derelict land into green space, transforms communities into healthier human environments by providing space for recreation and exercise.
4.05	The continued progression of the Contaminated Land Inspection Strategy also addresses 4 of the 6 goals set out in the Well Being of Future Generations Act (Wales) 2016; ‘a more resilient Wales’, ‘a globally responsible Wales’, ‘a prosperous Wales’ and ‘a healthier Wales’.
4.06	The financial and human resources provisions made by the Council enable these duties and responsibilities to continue to be fulfilled.

<b>5.00</b>	<b>IMPACT ASSESSMENT</b>
-------------	--------------------------

5.01	<p>Through the Integrated Impact Assessment process, the following was identified:</p> <table border="1" style="width: 100%; border-collapse: collapse;"> <tr> <td style="width: 50%; padding: 5px;">Long-term</td> <td style="width: 50%; padding: 5px;">Positive: The Contaminated Land Inspection Strategy does not have a direct impact on the Climate Change Target, however any remediation work undertaken could potentially have a positive impact. For example, through reducing the volume of gas emitted from historical landfill sites.</td> </tr> <tr> <td style="padding: 5px;">Prevention</td> <td style="padding: 5px;">No impact identified</td> </tr> </table>	Long-term	Positive: The Contaminated Land Inspection Strategy does not have a direct impact on the Climate Change Target, however any remediation work undertaken could potentially have a positive impact. For example, through reducing the volume of gas emitted from historical landfill sites.	Prevention	No impact identified
Long-term	Positive: The Contaminated Land Inspection Strategy does not have a direct impact on the Climate Change Target, however any remediation work undertaken could potentially have a positive impact. For example, through reducing the volume of gas emitted from historical landfill sites.				
Prevention	No impact identified				

	Integration	No impact identified
	Collaboration	No impact identified
	Involvement	No impact identified
<b>Well-being Goals Impact</b>		
	Prosperous Wales	Positive
	Resilient Wales	Positive
	Healthier Wales	Positive: Compliance with our statutory land contamination duties will have a positive impact on public health.
	More equal Wales	No impact identified
	Cohesive Wales	No impact identified
	Vibrant Wales	No impact identified
	Globally responsible Wales	Positive

<b>6.00</b>	<b>APPENDICES</b>
6.01	1) Contaminated Land Inspection Strategy – 2023 2) Summary of updates

<b>7.00</b>	<b>LIST OF ACCESSIBLE BACKGROUND DOCUMENTS</b>
7.01	<b>Contact Officer:</b> Rachael Davies <b>Telephone:</b> 01352 703400 <b>E-mail:</b> <a href="mailto:rachael.davies@flintshire.gov.uk">rachael.davies@flintshire.gov.uk</a>

<b>8.00</b>	<b>GLOSSARY OF TERMS</b>
8.01	<b>Remediation:</b> a term used to refer to the steps taken to either remove unacceptable levels of land contamination or to reduce it to an acceptable level.  <b>Financial Year:</b> the period of 12 months commencing on 1 April.  <b>Revenue:</b> a term used to describe the day-to-day costs of running Council services and income deriving from those services. It also includes charges

for the repayment of debt, including interest, and may include direct financing of capital expenditure.

**Capital:** a term used to describe the money set aside by the Council to ensure that there is enough money for a particular activity or service to go ahead.

**Budget:** a statement expressing the Council's policies and service levels in financial terms for a particular financial year. In its broadest sense it includes both the revenue budget and capital programme and any authorised amendments to them.

# Contaminated Land Inspection Strategy

Revision 6 | October 2023

## Foreword

This Contaminated Land Strategy describes how Flintshire County Council is required to identify sites within its administrative control that may be affected by land contamination. ~~The document~~ It also explains the statutory guidance, legislative provisions, processes, and procedures that the Council will follow in order to investigate those sites, to identify ~~statutory~~ Contaminated Land where necessary and to remediate Contaminated Land.

The Council last published its Contaminated Land Strategy in February 2013 ~~2019~~. Since then a number of ~~investigations to assess~~ land contamination ~~assessments~~ have been carried out and significant changes to legislation and guidance documents have taken place.

This revision of the Strategy has taken these changes into account and amendments have been made where necessary.

This revision of the Strategy replaces all previous revisions of Flintshire County Council's Contaminated Land Strategy.

Commented [RD1]: Updated date

Commented [RD2]: Updated terminology

Flintshire County Council

Community & Business Protection

Pollution Control

Ty Dewi Sant

Ewloe

Flintshire CH5 3FF

Commented [RD3]: Updated address & portfolio name



## Executive Summary

Land can be affected by contamination in the environment as a result of human activity and as a result of natural processes. The presence of contamination may cause harm or present risks to health, animals, buildings or the environment. However, just because contamination is present does not mean that the land is Contaminated Land or that there is a problem.

On 1st July 2001, legislation requiring land contamination to be investigated and addressed was enacted in Wales. The legislation is known as Part 2A of the Environmental Protection Act 1990 and it introduced a detailed way by which land contamination could be regulated. It charges each Local Authority with a duty to identify and investigate land which may be affected by contamination. It also requires Local Authorities to secure the remediation of land contamination where necessary.

The investigation and identification of land which may be affected by contamination is to be carried out in an ordered manner and each Local Authority, including Flintshire County Council, is required to publish a Contaminated Land Strategy to explain how this will be done.

A large number of sites may be identified as potentially affected by land contamination and Part 2A of the Environmental Protection Act 1990 requires the Council to investigate each one in a prioritised manner. This means that sites where the greatest harm is or is more likely to be taking place are to be investigated first. The prioritisation process takes into account the individual circumstances at each site and it will take place in 3 stages.

When the prioritisation process is complete, each site will be investigated in turn to understand the relationships, if any, between contamination and receptor.

Land contamination investigations **assessments** and the assessment of risk are carried out in phases. There are usually 4 phases.

1. Desk Study (preliminary risk assessment) **Preliminary Risk Assessment**
2. Intrusive Investigation (detailed risk assessment) **Detailed Risk Assessment**
3. Remediation
4. Verification

The outcome of the assessments carried out at each stage will determine if it is necessary to progress to the next stage. For example, if the Desk Study **stage 1** finds that there are likely to be unacceptable levels of contamination present then it will be necessary to carry out an **intrusive investigation stage 2**. If the intrusive investigation **stage 2** finds that there are unacceptable risks to receptors as a result of the presence of the contamination then **remedial works to remove or reduce those risks to acceptable level** **address those risks** will be necessary and the site may formally be determined as Contaminated Land.

The 'Polluter Pays' principle applies to Part 2A of the Environmental Protection Act 1990, and the responsibility for land contamination rests with those who caused it, the owner or occupier of the land or the person developing the land. The Council will make reasonable enquiries to identify and trace

Commented [RD4]: Updated terminology

Commented [RD5]: Updated terminology

Commented [RD6]: Updated terminology

Commented [RD7]: Updated terminology

Commented [RD8]: Updated terminology

Commented [RD9]: Updated terminology

those responsible for causing the contamination and each individual link between contamination and receptor and will offer them an opportunity to carry out remedial works voluntarily.

Land contamination at some sites may be found to be affecting Controlled Waters such as Rivers, Lakes, Streams and Groundwater. These sites are known as Special Sites and will be referred to Natural Resources Wales.

If the remedial work will not be carried out voluntarily, the Council and in the case of Special Sites Natural Resources Wales, may decide to take formal action against those responsible to secure the work.

A significant number of sites identified as a result of the prioritisation process will be put forward for development and investigated through the planning process.

The Council's development control and planning function already plays a key role in many aspects of pollution prevention and control.

Land contamination is a material planning consideration and so it must be taken into account by the Council when assessing an application for planning permission and when deciding whether or not to grant planning permission.

Many applications are received for sites that may be affected by land contamination and the presence of contamination in the ground can present not only risks to health, structures and the environment but can also adversely affect or restrict the use of the land. The development of the land offers an opportunity to investigate and address those risks and to restore the beneficial use of the land.

The Council has produced an advisory guide 'The Development of Land Affected by Contamination – Reports to Support Planning Applications' to complement this Strategy.

Where there is a possibility that the site intended for development is affected by contamination, the developer will be required to demonstrate that contamination present at the site may will reasonably be addressed and that once developed, the site is suitable for the use proposed and is incapable of being formally determined as statutorily Contaminated Land in accordance with the provisions of Part 2A the Environmental Protection Act 1990.

The Council will carry out regular reviews of its the Contaminated Land Strategy and each site that the prioritisation process has identified. If the circumstances at a site have changed, its priority may

change and it may be inspected for the first time or it may be inspected again.

**Commented [RD10]:** Replace 'may' with 'will'

**Commented [RD11]:** Substitute word

## 1.0 | Introduction

Land can become affected by contamination as a result of human activity, a previous use of the land or natural processes which leave behind contamination that may or may not reduce or disappear over time.

Wales has a long and varied industrial history. Industrial activities, pollution and waste disposal have left Wales with a legacy of contamination.

It is not only Wales' industrial past that has contributed to land contamination, some natural process have also played their part. The varied and complex geology that underlies Wales is rich in minerals and metals which over time have found their way into shallower ground and it is common to find high levels of some in the soil.

In some cases, the levels of contamination present may be capable of causing unacceptable risks of harm to human health or the environment and be sufficient for the land to be considered Contaminated Land.

Every Local Authority, including Flintshire County Council, has a duty imposed on **upon** it by Part 2A of the Environmental Protection Act 1990, to identify and investigate **inspect** land **that may be affected** **where there is reasonable ground to suspect that it may be affected** by contamination. A large number of sites may be identified as potentially contaminated and the legislation requires that these sites are investigated **assessed** in a prioritised manner. Sites where the greatest harm is occurring or is likely to occur are investigated **assessed** first.

This Contaminated Land Strategy describes how Flintshire County Council is required to identify sites within its administrative control that may be affected by land contamination and it explains the steps that the Council will take to investigate **assess** the land and secure the remediation of contamination.

Commented [RD12]: Substitute word

Commented [RD13]: Update terminology

Commented [RD14]: Update terminology

Commented [RD15]: Update terminology

Commented [RD16]: Update terminology

Commented [RD17]: Update terminology

## 2.0 | Objectives

This Strategy has a clear aim to promote, support and complement legislative requirements, Government, Welsh Government and the Council's own policies and priorities to protect and improve Public Health and the environment in which we live.

### The key objectives of the Strategy are;

- To identify and remove unacceptable risks to human health and the environment reduce the amount of land contamination in Flintshire,
- To ensure compliance with legislation, regulations and guidance,
- To ensure that enforcement action is taken if necessary,
- To encourage the redevelopment of previously developed land and to promote the principles of sustainable development,
- To ensure that where redevelopment takes place, land contamination is addressed,

- To explore and address the Council's own liabilities,
- To minimise new liability to the Council from the sale and purchase of land,
- To minimise unnecessary costs of dealing with land contamination to taxpayers, businesses and individuals.
- To enhance and protect the natural environment and biodiversity
- To take account of the effect of climate change on the lifespan of remediation measures
- The objectives of the Strategy support not only the themes, improvement objectives and priorities within the Council's Corporate Plan Council Plan 2019-2023 and Well Being Objectives 2017 but also deliver the Welsh Government's Enforcement Priorities for Wales, National Well Being Goals as set out in the Well Being of Future Generations Act 2015, the Environment Act Wales 2016, and the Flintshire Public Service Board's Well Being Assessment and shared priorities.

**Commented [RD18]:** Align language with other relevant documents

### 3.0 | Regulatory Context

On 1st July 2001, Part 2A of the Environmental Protection Act 1990, statutory guidance and

Regulations (The Contaminated Land (Wales) Regulations 2001) associated with it were enacted in Wales to replace Section 79 of the Environmental Protection Act 1990 to provide Local Authorities and the Natural Resources Wales with a means of identifying and addressing unacceptable risks to health or the environment from land contamination.

Before Part 2A was enacted, the provisions of Section 79 of the Act were very limited and meant that action could only be taken where land contamination was found to be causing a statutory nuisance in terms of human health.

There was little known about how land contamination could cause a statutory nuisance and as a result, action was rarely taken.

The introduction of Part 2A meant that action could be taken where land contamination was found to be a risk to human health, the natural or the built environment and it encourages the remediation of land to make it suitable for use and avoids unnecessary blight.

In April 2012, new statutory guidance (Welsh Government (2012), Contaminated Land Statutory Guidance) was published by the Welsh Government to replace the previous statutory guidance which was published to support the introduction of Part 2A in 2001.

Investigations Assessments may be carried out in accordance with the provisions of Part 2A where there is reasonable ground for the Council to suspect that the land may be affected by contamination, where there is no other identifiable breach of other pollution prevention controls and where there is no other appropriate alternative solution or where the land has not been put forward for development.

**Commented [RD19]:** Update terminology

There are other regulatory controls in place which complement Part 2A and prevent new contamination from being caused.

Other regulatory regimes such as the Environmental Damage (Prevention and Remediation) Regulations 2009 and the **regulatory** regimes for water resources, waste and environmental permitting also provide a means of addressing some land contamination issues.

Commented [RD20]: Insert word 'regulatory'

Changes were made to Part 2A in Wales in 2006, to extend it to include radioactive contamination of land (The Radioactive Contaminated Land (Modification of Enactments) (Wales) (Amendment) Regulations 2007). Further changes were made in 2007, to include radioactive contamination from nuclear installations.

Although legislative provision has been made for action to be taken it is considered unlikely that many sites satisfying the criteria that it sets out will be found.

## 4.0 | Role of the Regulator

Land contamination is a highly complex interdisciplinary field involving the analysis of chemical, physical, biological and legal interactions between soil, rocks, water, nature and society.

The Council fulfils the primary regulatory role for Part 2A and is responsible above any other for ensuring that the requirements of Part 2A are met and where appropriate, enforced.

Land contamination at some sites may be found to be affecting Controlled Waters such as Rivers, Lakes, Streams, the Sea and Groundwater. These sites are known as Special Sites and will be referred to Natural Resources Wales, the Regulator responsible for the regulation of Special Sites.

As Local Planning Authority (LPA), the Council is required to ensure that land contamination is given due consideration where land is put forward for development. The development of land is discussed in more detail in Section 7.1.2 of this Strategy.

## 4.1 | The Council's Role

As primary regulator, the Council has a duty to identify and inspect land in Flintshire that **where there is reasonable ground to suspect that it** may be affected by contamination and to secure **remedial remediation** works to address unacceptable risks that this may present.

Commented [RD21]: Update terminology

Commented [RD22]: Substitute word

### Part 2A requires the Council to;

- Produce and publish an inspection strategy (Contaminated Land **Inspection** Strategy)
- Implement and review the Contaminated Land **Inspection** Strategy
- Identify and inspect land which may be affected by contamination
- Decide what, if any, remediation is required
- Identify and trace those who should bear responsibility for remediation
- Ensure that remediation is carried out
- Take enforcement action for all Contaminated Land sites that are not Special Sites
- Refer Special Sites to Natural Resources Wales

Commented [RD23]: Insert word

Commented [RD24]: Insert word

- Keep, maintain and publish a Public Register of **specific** regulatory actions

Commented [RD25]: Insert word

The Council's Public Protection **Community and Business Protection** service employs a **full-time** Contaminated Land Officer to lead on and deal with land contamination issues.

Commented [RD26]: Update name of service area

Commented [RD27]: Insert hyphen

## 4.2 | Natural Resources Wales Role

Natural Resources Wales is responsible for the protection of Controlled Waters such as Groundwater, River, Lakes and Streams.

Land contamination at some sites may be found to be affecting Controlled Waters. These sites are known as Special Sites and will be referred to Natural Resources Wales by the Council.

### Part 2A requires Natural Resources Wales to;

- Assist the Council where the pollution of Controlled Waters is a concern
- Provide advice to the Council where the pollution of Controlled Waters is a concern
- Take enforcement action for Special Sites
- Publish periodic reports on the condition of the environment

Natural Resources Wales employs a Contaminated Land and Groundwater **specialist** team.

Commented [RD28]: Insert word

## 5.0 | Definitions and Principles

Land may only be considered as statutorily Contaminated Land if it meets the definition given in Part 2A **of the Environmental Protection Act 1990.**

Commented [RD29]: Insert full name of primary legislation.

The principles of risk assessment are applied when considering whether or not the definition has been met. This means that the probability and frequency of the exposure to the contamination are assessed with the magnitude and seriousness of the consequences.

To make a decision as to whether or not land meets the statutory definition, the person charged with responsibility for land contamination must understand not only the investigation process but also the scientific principles involved. They must also understand the complex risks associated with land contamination assessments and so to carry out the assessment itself, that person must be appropriately qualified, **professionally accredited** and competent to undertake the work and have sufficient expertise and relevant experience.

Commented [RD30]: Update terminology

## 5.1 | Pollutant Linkages

In the context of land contamination, there are 3 elements to any risk but the risk may only be considered to be present if each of the 3 elements is present.

### The 3 elements are

1. Contaminant (or source of contamination) – a substance that is in, on or under the land that has the potential to cause harm or to cause pollution of controlled waters (for example rivers, streams, lakes, groundwater)
2. Pathway – a route or way in which a receptor could be exposed to, or affected by a contaminant.
3. Receptor – Something or someone that could be affected by a contaminant.

Where all 3 elements are present, this is known as a pollutant linkage. There may be more than one pollutant linkage present at a site and some pollutant linkages may be connected. For example, one contaminant may affect more than one receptor along more than one pathway.

Once the potential contaminants, pathways, receptors and potential pollutant linkages have been identified, these are used to put together a Conceptual Site Model.

The Conceptual Site Model is a compilation of all the potential pollutant linkages. It is a very important part of the land contamination assessment process and although it can be expressed as a table, a diagram or both, it is important that it is presented in a format that can be easily followed through and back through each phase.

It is used to understand and identify potential pollutant linkages and interactions between them, to design the intrusive investigation, to inform the detailed risk assessment and to design and verify remedial works.

### 5.1.1 | Managing Risks from Land Contamination

To make a judgement and decide whether or not the risk posed by the presence of land contamination at a site is acceptable, a number of factors are taken into account.

The purpose of each phase of the land contamination assessment process is to provide the information required to inform this decision and to provide an explanation of how the decision has been reached.

It is important to understand what the risks are, if any, that could be caused by contamination and whether or not those risks are acceptable.

It is not always either reasonable or practicable to clean up contamination completely but by the time that the assessment process is complete, risks should have been identified, anticipated and assessed and one or more solutions to remove or reduce unacceptable risks to acceptable levels should have been identified.

## 5.2 | Definition of Contaminated Land

Land can be affected by contamination in the environment as a result of human activity and as a result of natural processes. The presence of contamination may cause harm or present unacceptable risks to health, animals, buildings or the environment. However, just because a piece of land has been developed in the past does not mean that it is contaminated and just because contamination is present does not mean that the land is Contaminated Land or that there is a problem.

Some sites that are affected by contamination are affected to the extent that the receptors are being affected or that risks to the receptors are too great. This land could be considered **statutorily** Contaminated Land as defined by Part 2A of the Environmental Protection Act 1990.

Commented [RD31]: Remove word

The definition of Contaminated Land is given in Section 78A(2) of the Environmental Protection Act 1990 as;

“any land which appears to the local authority in whose area it is situated to be in such a condition, by reason of substances in, on or under the land, that –

(a) significant harm is being caused or there is a significant possibility of such harm being caused; or (b) pollution of controlled waters is being caused, or there is a significant possibility of such pollution being caused;....”

## 5.3 | Harm

When deciding whether or not land contamination found to be present is capable of causing an effect on receptors, the Council will consider the categories and forms of harm that are illustrated in the statutory guidance.

### 5.3.1 | Harm to Non-human Receptors

The term ‘harm’ is explained in Section 78A(4) and it means harm to the health of a living organism or organisms or other interference with the ecological systems of which they form part and, in the case of humans, includes harm to their property.

The effects of contamination on non-human receptors are explained in Table 1 and Table 2 as follows;



**Table 1: Ecological system effects**

Relevant types of receptor	Significant harm	Significant possibility of significant harm
<p>Any ecological system, or living organism forming part of such a system, within a location which is:</p> <ul style="list-style-type: none"> <li>• a site of special scientific interest (under section 28 of the Wildlife and Countryside Act 1981)</li> <li>• a national nature reserve (under s.35 of the 1981 Act)</li> <li>• a Marine Conservation Zone*</li> <li>• an area of special protection for birds (under s.3 of the 1981 Act)</li> <li>• a “European site” within the meaning of regulation 8 of the Conservation of Habitats and Species Regulations 2010</li> <li>• any habitat or site afforded policy protection</li> </ul>	<p>The following types of harm should be considered to be significant harm:</p> <ul style="list-style-type: none"> <li>• harm which results in an irreversible adverse change, or in some other substantial adverse change, in the functioning of the ecological system within any substantial part of that location; or</li> <li>• harm which significantly affects any species of special interest within that location and which endangers the long-term maintenance of the population of that species at that location.</li> </ul>	<p>Conditions would exist for considering that a significant possibility of harm exists to a relevant ecological receptor where the local authority considers that:</p> <p>Significant harm of that description is more likely than not to result from the contaminant linkage in question; or</p> <p>there is a reasonable possibility of significant harm of that description being caused, and if that harm were to occur, it would result in such a degree of</p>

\* Marine Conservation Zones upon commencement of Part 5 of the Marine and Coastal Access Act 2009

**Table 2: Property Effects**

Relevant types of receptor	Significant harm	Significant possibility of significant harm
<p>Property in the form of:</p> <ul style="list-style-type: none"> <li>• crops, including timber;</li> <li>• produce grown domestically, or on allotments, for consumption;</li> <li>• livestock;</li> <li>• other owned or domesticated animals;</li> <li>• wild animals which are the subject of shooting or fishing rights.</li> </ul>	<p>For crops, a substantial diminution in yield or other substantial loss in their value resulting from death, disease or other physical damage. For domestic pets, death, serious disease or serious physical damage. For other property in this category, a substantial loss in its value resulting from death, disease or other serious physical damage. The local authority should regard a substantial loss in value as occurring only when a substantial proportion of the animals or crops are dead or otherwise no longer fit for their intended purpose. Food should be regarded as being no longer fit for purpose when it fails to comply with the provisions of the Food Safety Act 1990. Where a diminution in yield or loss in value is caused by a contaminant linkage, a 20% diminution or loss should be regarded as a benchmark for what constitutes a substantial diminution or loss. In this Chapter, this description of significant harm is referred to as an “animal or crop effect”.</p>	<p>Condition would exist for considering that a significant possibility of significant harm exists to the relevant types of receptor where the local authority considers that significant harm is more likely than not to result from the contaminant linkage in question, taking into account relevant information for that type or contaminant linkage, particularly in relation to the ecotoxicological effects of the contaminant.</p>

<p>Property in the form of buildings. For this purpose, “building” means any structure or erection, and any part of a building including any part below ground level, but does not include plant or machinery comprised in a building or, buried services such as sewers, water pipes or electricity cables.</p>	<p>Structural failure, substantial damage or substantial interference with any right of occupation. The local authority should regard substantial damage or substantial interference as occurring when any part of the building ceases to be capable of being used for the purpose for which it is or was intended. In the case of a scheduled Ancient Monument, substantial damage should also be regarded as occurring when the damage significantly impairs the historic, architectural, traditional, artistic or archaeological interest by reason of which the monument was scheduled. In this Chapter, this description of significant harm is referred to as a “building effect”.</p>	<p>Conditions would exist for considering that a significant possibility of significant harm exists to the relevant types of receptor where the local authority considers that significant harm is more likely than not to result from the contamination linkage in question during the expected economic life of the building (or in the case of a scheduled Ancient Monument the foreseeable future), taking into account relevant information for that type of contaminant linkage.</p>
--	--	--

### 5.3.2 | Harm to Human Health

So far as human health is concerned, there is no absolute set of circumstances in which or thresholds above which land is considered Contaminated Land and so making an informed decision is highly complex.

Health effects that will always be considered as causing significant harm are;

- life-threatening diseases such as cancers,
- diseases that are likely to have a serious impact on health,
- serious injury caused by chemical and biochemical properties of a substance but not its physical properties for example, if it is hard or sharp, birth defects, impairment of reproductive function and death.

Other health effects that may be considered as causing significant harm are;

- physical injury,
- gastrointestinal disturbances,
- effects on the respiratory tract,
- effects on the cardio-vascular system,
- skin ailments,
- effects on the central nervous system,
- effects on the organs
- a range of other impacts on health.

Explanations of what should be taken into account in reaching a decision on what is 'significant harm' and what is the 'significant possibility of such harm' are provided in Section 4 of the statutory guidance.

## 6.0 | The Council's Policies

The Council has a large number of policies, strategies and plans which affect the way in which the Council carries out its business and which shape the way in which it provides services. ~~to its customers.~~

**A number of those policies, strategies and plans have relationships and synergies not only between each other but also with the Contaminated Land **Inspection** Strategy including,**

- ~~The 'County Vision' and Community Strategy 2009-2019~~
- ~~Flintshire County Council Annual Improvement Plan 2019-2023~~
- ~~Flintshire Unitary Development Plan~~
- ~~Public Protection **Community and Business Protection** Enforcement Policy~~
- ~~Public Protection Service **Community and Business Protection** Strategy and Action Plan **Strategic and Operating Plan**~~
- ~~Flintshire Biodiversity Action Plan~~
- ~~Environment Directorate **Community and Business Protection** Plan~~
- Flintshire Regeneration Strategy

There are also direct relationships with Government policies and the Contaminated Land **Inspection** Strategy has particular regard to the following Welsh Government policies;

- Welsh Government, Local Better Regulation Office, National Enforcement Priorities for Wales
- Welsh Government, Environment Strategy for Wales
- Priority 2: Ensuring the safety and quality of the food chain to minimise risk to human and animal health
- Priority 4: Improving the local environment to positively influence quality of life and promote sustainability
- National Well Being Goals, Well Being of Future Generations Act 2015.

The Contaminated Land Strategy has been produced in consideration of relevant policies and plans.

## 7.0 | Characteristics of Flintshire

As this Strategy explains, land contamination assessments will be carried out in an ordered manner and individual sites will be ~~investigated~~ **assessed** according to their priority. The process that will be followed to prioritise sites is explained in Section 9.3.

**Commented [RD32]:** Reduced length of sentence

**Commented [RD33]:** Insert word

**Commented [RD34]:** Align language with other documents.

**Commented [RD35]:** Insert word

**Commented [RD36]:** Update terminology

To begin to identify and organise the sites which may need to be assessed, it is important to understand the particular natural and man-made features and history of the County so that each can be taken into account.

It is important to understand where people live, where they work, what they have built, what they have used, what happened in the past and what may have been left behind as a result.

## 7.1 | Geographical Location

The County of Flintshire is situated in north east Wales and is one of the 6 unitary authorities of North Wales. It is shown on the map below.

Commented [RD37]: Map legend updated

The County of Denbighshire and the Clwydian Range are found at Flintshire's western border and the County of Wrexham is found to the south.

The English County of Cheshire is found at Flintshire's eastern border and the northern area of Flintshire is bordered by the tidal estuary of the River Dee and the Irish Sea.

The English counties of Wirral and Merseyside are found across the Estuary.



## 7.2 | History

Until the Welsh Local Government Reorganisation that took place in 1996, Flintshire was a part of the North Wales County of Clwyd and 2 councils; Delyn Borough Council and Alyn and Deeside District Council, were primarily responsible for its administration.

Clwyd County Council was formed in 1974 and incorporated most of the original County of Flintshire. The current extent of Flintshire is very different to the ancient County of Flintshire.

Before 1974, Flintshire was one of few counties in Britain to retain exclaves. Exclaves are detached areas of a County, surrounded entirely by other Counties. The administrative area of Flintshire comprised the borough of Flint, the urban districts of Buckley, Mold and Connah's Quay, the rural and urban districts of Holywell, the rural district of Hawarden, the district of Rhuddlan and the exclave rural district of Maelor.

During the reorganisation, the district of Rhuddlan was incorporated into Denbighshire and the rural district of Maelor was incorporated into Wrexham.

Since 1996, Flintshire has been a unitary authority and is administered by Flintshire County Council.

## 7.3 | Population Size and Distribution

Flintshire covers an area of 43,464 hectares. Including the River Dee Estuary, it covers an area of 49,891 hectares.

According to the Office for National Statistics, the population of Flintshire was c157,000 in 2020.

Commented [RD38]: Updated statistic

There are 9 principal settlements in Flintshire and residential areas are concentrated along the coastal areas of the County. Most residents live in and around the towns of Connah's Quay, Shotton, Queensferry, Mold, Buckley, Holywell, Bagillt and Hawarden.

The map below illustrates the way in which the population of Flintshire is distributed.

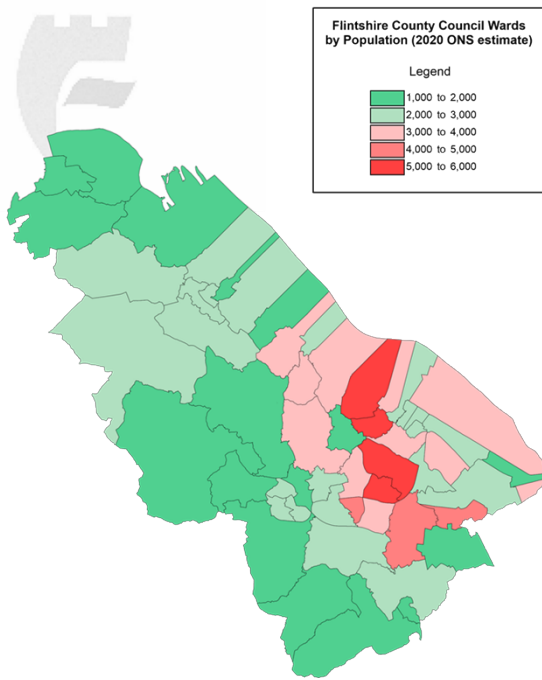

A large area of Flintshire is rural and there are many smaller settlements and villages dispersed across the County, a number of which include environmental conservation areas, listed buildings and scheduled ancient monuments

Commented [RD39]: Added descriptions

## 7.4 | Geology

The geology of Flintshire is complex and varied as it is comprised from a succession of rocks from the

Silurian (the period from about 444 to 420 million years ago) to the Triassic (the period from about 250 to 200 million years ago) age. Many of its features have been exploited to support local mines and quarries over centuries.

The high moorlands of the Clwydian Range are formed from Silurian grits and shales and the upland area of Halkyn Mountain is formed of Carboniferous Limestone deposits.

The outcrop of limestone is about 4 miles wide in the North and narrows to about 1 ½ miles wide as it approaches Flintshire's border with Denbighshire at Loggerheads.

The limestone deposits continue to be quarried today and are crossed by many metalliferous and calcite veins which have been extensively mined in the past.

Several lead and zinc and lead and silver mines were operated where the veins are present, particularly in the area of Halkyn Mountain.

The limestone is overlain by Millstone Grit; coarse-grained sandstones and Holywell Shales; sometimes called 'black limestone', which outcrop from the north to the south, immediately east of the Limestone at Halkyn Mountain and Nercwys Mountain.

In most areas, the Millstone Grit is formed from silica sandstone but towards the north it is formed by chertstone, a fine-grained rock containing silica and quartz. These features have also been quarried over time.

The eastern area of Flintshire is underlain by coal measures known as the Flintshire Coalfield, which ranges from Point of Ayr in the north to Caergwrle in the south.

The Flintshire Coalfield is made up from many different seams and has been mined extensively in the past. Some seams are present in the north, some are present in the south and some are present across the whole area and some extend underneath the River Dee Estuary.

Where the land lies below approximately 600ft above sea level, the bedrock is overlain by other deposits such as glacial boulder clay, sands and gravels.

These deposits have been widely exploited and used to support local industries, particularly brick and pottery making. Sand and gravel deposits continue to be quarried today.

Triassic rock formations, including sandstones are found toward Higher Kinnerton in the south east.

More recent geological deposits such as tufa, a type of limestone, are found at Caerwys.

## 7.5 | Hydrology

Flintshire has a variety of rivers, streams and pools including the River Dee and its estuary, the River Wheeler, the River Alyn and the River Terrig.

The flow and path of the rivers are strongly influenced by mine spoil, workings and drainage tunnels, and other features such as caverns within the limestone.



### 7.5.1 | River Dee and River Dee Estuary

The River Dee rises in Dduallt in the Snowdonia National Park in Gwynedd. It flows through Snowdonia to and through Bala Lake and to Llangollen in Denbighshire. It then flows to the east of Wrexham and along the border between England and Wales. It flows into England and through Chester until passing through Cheshire's border with Flintshire and back into Wales at Saltney.

It then flows on through Sealand and Queensferry before reaching its estuary with the Irish Sea at Connah's Quay.

The lower section of the River Dee is influenced by the tide.

A stretch of the River Dee has been canalised and flows along a manmade channel which alters its natural course.

Before the River was canalised it flowed past Parkgate and followed the west shore of the Wirral Peninsula. After it was canalised, it followed the North Wales Coast and the areas of Sealand, Shotton and Queensferry were reclaimed from the Estuary.

The River Dee was especially important historically as it provided an inexpensive means of transporting products from local industries and producers. It also provided access to the Irish Sea and made the Docks at Liverpool, Ellesmere Port and Manchester easily accessible creating opportunities for world trading.

Today **More recently**, the River Dee is **has been** used to transport A380 aircraft wings on a barge from the Airbus factory at Broughton to the Port of Mostyn.

**Commented [RD40]:** Substitute words

**Commented [RD41]:** Update tense

The River Dee Estuary is of great environmental importance internationally and its extensive salt marshes are especially important to waterfowl, birds and other wildlife. It is a designated Site of Special Site of Scientific Interest (SSSI) and Ramsar site.



## 7.5.2 | River Alyn

The River Alyn rises at the southern end of the Clwydian Range and flows in a southerly direction through the Alyn Valley, part of the Clwydian Range Area of Outstanding Natural Beauty (AONB).

It flows through carboniferous limestone from Halkyn Mountain, through the Alyn Gorge between Loggerheads and Rhydymwyn and toward and through Loggerheads at Flintshire's border with Denbighshire, it then flows through Mold to Cefn y Bedd where it meets and joins the River Dee just over Flintshire's border in Wrexham.

During the summer, the River Alyn flows underground through subterranean caves and potholes that have been formed in the limestone as a result of the flow of water over time. For several months a year, the river bed is dry in places.

The flow of water over the limestone surface has also caused many swallowholes to be formed.

The flow in the River Alyn is affected by drainage from historical metal mines, in particular the Milwr Tunnel which was built to drain water from and prevent flooding in mine workings in Halkyn Mountain centuries ago.

The Milwr Tunnel diverts water away from the River Alyn catchment and carries it directly to the River Dee where it discharges into the River Dee Estuary at Bagillt.

A stretch of the River Alyn in Rhydymwyn was canalised just before the Second World War broke out to allow for the construction of the Valley Works, a munitions storage and manufacturing complex. More information about this site can be found in Section 7.10.7 of this document.

## 7.5.3 | River Terrig

The River Terrig rises at Llyn Cyfynwy in Denbighshire, a short distance from the place where the River Alyn rises, and flows north and east toward Flintshire and between the Flintshire villages of Treuddyn and Nercwys. It eventually joins the River Alyn at Pontblyddyn.

## 7.5.4 | River Wheeler

The River Wheeler rises a short distance from Afonwen and flows in a northerly direction through Ysceifiog and Melin y Wern before it flows across Flintshire's border with and into Denbighshire toward the River Clwyd before flowing into the Irish Sea at Rhyl.

## 7.6 | Hydrogeology

Hydrogeology involves the study of the distribution and movement of groundwater (water found in soil pore spaces and in geological layers), in the soil, underlying geological layers, features and aquifers.

An aquifer is made up of underground layers of water-bearing geological features such as rock, gravel and sand from which groundwater can be abstracted using a well or a borehole.

Groundwater is a valuable source of water, provides flow to rivers and is very vulnerable to pollution.

Groundwater moves slowly through the ground and does not necessarily follow the direction or topography of the ground at the surface. The movement of groundwater is often dependant on pressure gradients which means that in the ground, water does not always flow downhill and can flow uphill.

In April 2010, the Environment Agency and Natural Resources Wales made changes to the aquifer designations in their Groundwater Vulnerability Maps to make them consistent with the Water Framework Directive. Major and minor aquifers are now called principal and secondary aquifers respectively.

Commented [RD42]: Insert 'Natural Resources Wales'

There are 4 secondary aquifers in Flintshire, found within the following geological features:

- Kinnerton Sandstone Formation
- Carboniferous Limestone
- Sandstones in the Halkyn Formation
- Sandstones in the Westphalian Strata

The most important aquifer in Flintshire is the Kinnerton Sandstone Formation which is used to support public drinking water supplies.

The second most important aquifer in Flintshire is the Carboniferous Limestone. The movement of groundwater in this aquifer is restricted to fissures and natural features which have been created by the movement of water through the rocks. It is also influenced by mine workings from historical lead mines and drainage tunnels serving the mines.

The soils which overly the aquifers are different and range from soils with a high leaching potential, where contamination can move through the ground easily, to those with a low leaching potential, where contamination does not move quite so easily through the ground.

Aquifers overlain by soils with a high leaching potential are more vulnerable to pollution than those with lower leaching potentials.

Areas which are particularly vulnerable to pollution and at risk of contamination are protected by zones imposed by the Environment Agency. Natural Resources Wales. Industrial operations and activities which could potentially cause pollution are subject to restrictions and pollution prevention measures to minimise risks to the groundwater, wells, springs, boreholes and water supplies. There are 5 Groundwater Source Protection Zones in Flintshire. Large areas of Flintshire are also protected by the Conservation of Habitats and Species Regulations as the many of the designated environmental conservation sites including the River Dee, are sensitive to the presence of phosphorous.

Commented [RD43]: Insert 'Natural Resources Wales'

Commented [RD44]: Insert reference

## 7.7 | Water Resources

The River Dee is an important source of drinking water. Three water companies take water from the River at 3 abstraction points above the weir in Chester. Water for drinking water is only abstracted above the weir as the stretch of the River below it is tidal and the water brackish.

The water, once it has been treated and made potable (suitable to drink), is distributed to northeast Wales, Cheshire and Merseyside. The demand for drinking water in Merseyside is greater than local supplies can support and water from the River Dee is used to meet the demand.

Water is not only taken from the River for drinking water but is also taken to be used by industry. Industries which abstract water from the River Dee include a papermill, Connah's Quay Power Station and the Shropshire Union Canal (British Waterways).

A large amount of water is taken from the River Dee and during the summer months the flow of the River is reduced. Water accumulated and stored in reservoirs in Denbighshire and Gwynedd during the winter is released into the River to support the abstractions.

The abstraction of water from the River is very closely regulated by the Environment Agency **Natural Resources Wales** and a consortium of water companies in accordance with the River Dee Regulation Scheme. The Scheme includes the management of abstractions, flow, water quality monitoring and pollution alerts.

Groundwater is another very important source of drinking water in many areas. It is found deep underground and can be used for large scale public supplies and for smaller private supplies.

There are 132 **around 150** private water supplies in Flintshire. Most of these are used by people in rural areas.

Water companies are required by law to test the water that they supply to ensure that it is safe to drink but those people that use a private water supply do not have to test the water that they use in the same way and so it is very important that any potential sources of contamination such as oil leaks or spills are reported.

Groundwater for public drinking water supplies is abstracted from 2 boreholes drilled deep into the aquifer in the sandstone between Bretton and Kinnerton in the southern area of Flintshire.

The River Dee is also an important fishery. The Estuary supports large Cockle beds and Salmon and Sea Trout can be found along its entire length.

The River has a high amenity value and is a popular place for coarse fishing, sailing and bird watching.

## 7.8 | Protected Habitats and Areas of Conservation

There are many common place and rare plant and animal species which can be found in Flintshire and there are an increasing number of designated wildlife and conservation sites in place to protect them.

**Commented [RD45]:** Insert 'Natural Resources Wales'

**Commented [RD46]:** Updated statistic

In Flintshire, there are 25 [28](#) sites Special Sites of Scientific Interest (SSSI), 6 Special Areas of Conservation (SAC), 1 Ramsar (Ramsar Convention – Wetland of International Importance) site, 1 Outstanding Area of Natural Beauty (AONB). 4 [2](#) Special Protection Areas and several more potential sites for designations.

Commented [RD47]: Updated statistic

More information about designated conservation sites is available from Natural Resources Wales and more information about protected species is available from the County Ecologist.

Where land contamination assessments are required at any of these sites, Flintshire County Council will have regard to and will take account of the designation and features of each one and will consult Natural Resources Wales.



## 7.9 | Sites of Historic Importance

Flintshire is rich in natural resources which have been exploited since at least the Roman era and have supported local industries for hundreds of years.

This has rewarded the County with distinctive landscapes ranging from the beaches and sand dunes at Talacre, the shores and coastal salt marches of the River Dee Estuary, Common Land, woodlands, rolling farmland and the Clwydian Range. Most of these areas are designated conservation sites.

Historical activities have also given Flintshire an abundance of historical features and buildings and archaeological remains such as Iron Age hill forts, Roman remains, mine workings, castles and ancient pilgrimage sites.

There are 34 [32](#) conservation areas; areas of special architectural or historic interest, the character of which it is desirable to preserve and enhance, 868 [1032](#) listed buildings, 400 [133](#) scheduled ancient monuments and many sites where there may be archaeological remains and [1 Landscape of Outstanding Historical Interest](#) in Flintshire.

Commented [RD48]: Updated statistics

## 7.10 | What types of Contamination may be found?

The types of contamination that are likely to be found depends on the activity that took place on the land. Different substances are used by different industry and the type of contamination likely to be found is usually associated with the particular substances that were used, stored and produced.

Some materials, substances and wastes are commonly associated with particular processes and are more likely to be found at a site than others.

When assessing land contamination, it is very important to understand what to look for, where to look for it and why. It is important to carry out a thorough and detailed assessment of the processes which took place at a site including what was used, stored and produced and where.

Practices and processes can change over time and it is important to take this into account too as changes like this can affect the type of contamination that is likely to be found.

Flintshire has a long and varied industrial past and so there are many types of contamination that could be found.

Not all land contamination is caused by industrial activity. Some comes as the result of natural processes, such as the weathering of rocks and mineral veins in the ground, and takes place over a long time.

It is common to find elevated levels of lead and other metals in the soil around the lead mines and in areas where lead veins are present in underlying geological features.

Flintshire's industrial past follows its geological and geographical features. Industrial areas were concentrated, as they are today, around areas where minerals can be found and the River Dee and its Estuary.

Road and rail links with the rest of the Country- **Wales and the UK** were well developed and the River Dee allowed local products to be transported by river and sea to docks in Liverpool, Ellesmere Port and Manchester and made World trade possible.

The principal industries which have taken place in Flintshire are discussed in more detail in Sections 7.10.1 to 7.10.9 and it is likely that the land contamination assessments that will be carried out will be focussed in the areas where industrial processes have taken place.

**Commented [RD49]:** Insert specific reference to Wales

## 7.10.1 | Lead Mining

Lead is a heavy metal, an element which has metallic properties and which is usually toxic. It has a blue white colour which tarnishes to a dull grey when exposed to the air. When molten, it has a shiny, chrome like appearance.

Lead is also malleable and can be hammered or rolled into a thin sheet. It is this property which makes it particularly useful. It is commonly used in roofing products, bullets and shot, solders, radiation protection and batteries. Historically, it was commonly used to line coffins and storage tanks, in cosmetic products, as fishing line weights and as a fuel additive.

It is also toxic, causing damage to the nervous system and the brain and can accumulate in plant and animal tissues and the environment. For this reason, it is no longer used in many products.

Lead ore is found in metalliferous veins in limestone and lead deposits are often associated with deposits of zinc and silver.

The lead mines were concentrated in areas where limestone is present. The majority of Flintshire's lead mines were concentrated around the areas of Halkyn Mountain and Brynford.

In some areas of Flintshire, particularly around Trelawnyd and Pantybuarth, lead bearing veins can be seen in limestone outcrops at the surface of the ground.

Archaeological evidence shows that lead deposits in Flintshire have been exploited since the Roman era and historical records show that lead was mined in Flintshire from the early 13th Century, during the reign of King Edward 1st.

The lead in Flintshire was of particularly good quality and the lead mining industry in Flintshire boomed during the 1720s. To meet demand, skilled workers were brought from lead mines across the British Isles, in particular from the Peak District, Derbyshire and Cornwall to work under close supervision in Flintshire's lead mines.

The industry eventually went into decline during the late 19th Century as cheap lead and lead products became available from South Wales and international markets.

At this time, new industry prospered and a new Alkali factory in Flint opened offering employment to hundreds of local workers.

As the lead mines were extended deeper and deeper under the ground they became plagued by flooding. The industry was rejuvenated when a sea-level drainage tunnel was constructed to drain excess water from the mines beneath Halkyn Mountain.

The tunnel has been extended over time and reaches from Bagillt, by the River Dee Estuary to Cadole, close to Flintshire's border with Denbighshire. It is known as the Milwr Tunnel.

The original sea-level tunnel was extended by the Halkyn District United Mines Limited; an amalgamation of 9 mining companies and 2 drainage companies, to drain excess water from a number of lead mines to allow the mines to continue to operate and to allow them to be deepened to exploit ore contained in deep veins.

The tunnel intercepts a number of caverns, including a large cavern called Powell's Lode, formed naturally in the limestone by water beneath Halkyn Mountain. The caverns are popular with cavers and potholers and still contain some of the equipment that was used in the mines.

Today, the Milwr Tunnel is maintained by 2 water companies, United Utilities and Dwr Cymru (Welsh Water).

Evidence of Flintshire's lead industry is abundant today and although few structures remain on the surface, the landscape in some areas, particularly those around Halkyn Mountain is strongly influenced by abandoned mine shafts, spoil heaps and tailings.

Tailings are made up of the left over materials after the valuable part of the ore has been separated from the materials with little value.

Spoil heaps are piles of overburden and other wastes. They are not the same as tailings.

Overburden is term used to describe the rock and soil overlying the ore that is to be mined.

Lead mining has left behind not only physical evidence of past times but also a legacy of land contamination.

Land can be affected by contamination in the environment as a result of human activity and as a result of natural processes. The presence of contamination may cause harm or present risks to health, animals, buildings or the environment. However, just because contamination is present does not mean that the land is contaminated or that there is a problem.

If there is no way for the contamination to reach receptors (something or someone that would be sensitive to or whose health could be adversely affected by the presence of contamination) then there would be no way for the receptors to be affected.

It is very likely that some sites will be found to be affected by contamination to the extent that receptors are being affected or that risks to the receptors are too great. This land could be considered statutorily Contaminated Land as defined by Part 2A of the Environmental Protection Act 1990.

The revised Statutory Guidance, published in 2012, allows regulators to take 'normal' levels of contamination into account in their assessment of a site.

It is common to find elevated levels of lead and other metals in the soil around the lead mines and in areas where lead veins are present in underlying geological features.

This does not mean that the land is Contaminated Land nor does it mean that the levels are acceptable, may be dismissed or that there is no potential risk to receptors. Detailed assessments or investigations in these areas will be necessary.

In some of these areas, concentrations of lead and other metals are exceedingly high and are capable of causing adverse health effects.



To assess the potential extent of land contamination associated with lead mining activities, the Council is in the process of carrying out a detailed study and preliminary risk assessment. This will be used to develop and implement a supplementary strategy to assess, prioritise and investigate sites in and around the former lead mining areas. This will complement the Contaminated Land Strategy.

## 7.10.2 | Coal Mining

Coal is abundant across the World and was formed during the Carboniferous period (approximately 360 million years ago), the same period which saw the evolution of early reptiles.

It is a sedimentary rock formed over time from prehistoric vegetation which has become buried, heated and compressed.

The Ancient Greeks and Romans are known to have used coal and archaeological evidence shows that coal was used as a fuel by Romans in Britain.

Coal was not used extensively as a fuel until the industrial revolution and the invention of the steam engine which meant that coal was easier to mine.

Until then, coal was dug by hand from shallow bottle-shaped holes called Bell Pits and was brought to the surface using a bucket and chain on a hand-operated winding mechanism. Bell Pits can still be found in some areas of Flintshire including Ewloe.

The steam engine meant that large amounts of coal could be brought to the surface from deep in the ground. This turn meant that large mines could be extended to reach deep coal seams.

Coal mined from deep underground was brought through the mine on sledges or in small trucks pulled or pushed along roads and rails inside by miners or mules to be lifted to the surface up a shaft by a winding mechanism powered by an engine.

Historical records show that coal was being mined in Flintshire as early as the 13th Century, around the time that Flint Castle was built for King Edward 1st in 1277 and continued until the ~~open-cast~~ coal mine at Point of Ayr closed in 1996.

Over time, coal mines became established in Flint, Bagillt, Greenfield, Buckley, Mold, Pontblyddyn, Point of Ayr at Ffynnongroyw, Hawarden, Oakenholt, Leeswood and Coed Talon.

The coal mining industry in Flintshire was also important to its lead mining industry. Coal extracted from mines around Bagillt was used as fuel to heat the many lead smelters nearby.

The chimney from the lead works at Llanerch y Mor can still be seen. Its buildings have long been restored and are occupied by a haberdashery and craft centre.

### 7.10.3 | Clay, Pottery and Brick making

Areas of Flintshire, particularly around Ewloe, Buckley and Padeswood, are rich in high quality clays which have been extensively quarried and used to supply many brick works and potteries. The fireclays of Buckley were of exceptionally high quality and the town is famous for its brick and pottery products.

The first clay products were made commercially in Buckley during the 17th Century. The industry gradually grew over the years and boomed during the industrial revolution when engine power meant that large volumes of clay could be extracted from the ground and larger kilns could be operated.

As the industry grew, tramways were replaced with main gauge rail lines providing links with the rest of Wales, Chester and the docks along the River Dee. The canalisation of the River Dee in 1737 allowed products to be transported by river and sea to docks in Liverpool, Ellesmere Port and Manchester and made World trade possible.

The clay was used to make firebricks, tiles, kitchenware, drainage pipes and fittings, acid resistant bricks and silica bricks which were used as a lining in kilns, high temperature furnaces and metal smelters.

Quarrying the clay from the ground left behind enormous depressions in the ground. Some of these have filled with water and are used as fishing ponds and are protected wildlife sites. The remaining pits have been used as landfills to dispose wastes.

The last pottery operating in Buckley closed in 1946 and the last brickworks in 2003.

Many of the features of the historical brick works and potteries can still be seen along the Buckley Heritage Trail.

### 7.10.4 | Steel

Steel is an alloy made from iron, carbon and other materials such as titanium, chromium, manganese and vanadium.

At its time, the steel industry was one of the largest industrial processes operating in Flintshire. The Hawarden Bridge Steel Works was built by J. Summers and Co. Limited in 1896 and began producing steel in 1902. The company increased in size to such an extent that during the 1930s, it produced the greatest quantity of steel sheets in the country.

The works produced high grade steel sheets, steel sheets for vehicle bodies and corrugated roofing sheets. The company was eventually absorbed into British Steel.

Steel making in Shotton ceased in 1980, which saw 6,500 employees made redundant in one day.

The office building from the Hawarden Bridge Steel Works is still present and is a listed building.

British Steel was taken over by Corus in 1999 and continued to manufacture steel products.

The steelworks in Shotton is now operated by Tata steel and produces galvanised products, coated roofing and cladding products and other speciality items.

Smaller works operating at the time manufactured products including steel cables and chains, ferromanganese, spiegeleisen (a ferromanganese alloy with a distinctive rainbow colouring), window frames and tin plated products.

### 7.10.5 | Textiles

In 1777, a cotton spinning industry was founded in Holywell. The Yellow Mill was the first to open and the 2 more mills, the Upper and Lower Mills were constructed very soon afterwards during the 1780s. The Crescent Mill was opened shortly after in 1790.

The mills in Holywell prospered for a while but were unable to compete with larger mills in Manchester and Lancashire and as a result went into liquidation around 1841.

In 1848, the Crescent Mill was taken over and Wales' first power loom was installed there and was used to weave flannel.

The Welsh Flannel Manufacturing Company operated both the Crescent and Upper Mills and continued to produce flannel into the 1980's.

During the early 1900s, artificial silk was being produced by the British Glanzstoff Manufacturing Company at its factory in Flint. The factory was purchased and taken over by Courtaulds in 1917 and became the Aber Works.

Courtaulds manufactured viscose rayon from cellulose (a fibre found in the cell walls of green plants and algae), at the Aber Works and expanded production in Flint following the purchase of the old Muspratt Alkali Works by Flint Castle.

The Courtaulds Castle Works began producing viscose rayon in 1922.

Courtaulds also purchased the Holywell Textile Mill in Flint, which became the Deeside Mill and was used to produce yarn.

The viscose rayon industry in Flintshire was expanded further by Courtaulds when 2 more factories, Number 1 and Number 2, were constructed and opened in Greenfield.

The manufacture of viscose rayon ceased in Flintshire when Courtaulds factories in Greenfield closed in 1978.

The wastes from the factories were disposed at landfill sites close by. Since then, the landfills have been used to dispose other wastes too.

Extensive site investigations to assess the condition of the landfill sites that were used by Courtaulds to dispose wastes have been carried out in accordance with the provisions of Part 2A of the Environmental Protection Act 1990. None of the sites were found to be statutorily Contaminated Land.

## 7.10.6 | Quarries

There is an abundance of mineral resources in Flintshire which have been exploited for centuries.

Sands, gravels, clays, chert and limestone have been quarried extensively to be used in products including pottery, bricks, road stone, building materials and cement.

There are many quarries operating in Flintshire today recovering sands, gravels and limestone to be used as road stone, in tarmac, building materials, lime and cement products.



## 7.10.7 | Munitions

During the First World War, a munitions factory was established in Queensferry. The factory operated between 1915 and 1918 and manufactured Guncotton (a type of explosive) and TNT to be used in ammunition to be used by the armed forces.

The factory continued to operate on a smaller scale when the War was over. When the Second World War began, a second factory was built at Sandycroft.

In 1939, the Government's Ministry of Supply instructed a factory and storage facility for weapons to be built. The site was called Valley Works and was constructed in some of the tunnels left behind as a result of lead mining in Rhydymwyn. Some new tunnels were also excavated by Halkyn District and United Mining Company who were chosen to carry out the work as they had a great deal of experience of constructing local lead mines and had the equipment required to do the job.

The factory was used to manufacture mustard gas and the extensive tunnels were adapted so that ammunition, weapons and weapons filled with mustard gas could be safely stored inside. Mustard gas manufacture ceased in 1945.

A national and military secret at the time, the tunnels also included a specially adapted section where gold from the Bank of England could be evacuated to and kept safe during times of conflict.

The tunnels no longer contain any weapons or mustard gas and the site is managed by DEFRA and the Ministry of Defence - Defence Estates.

During the years between 1942 and 1945, the site was also used to research the potential for atomic weapons to be produced commercially to be used during WWII and for the development of atomic weapons and atomic power. The work was code named 'Tube Alloys'. Research into atomic technology continued into the 1990's. Some of the atomic scientists' notes and calculations can still be read from writing on the walls of some of the buildings remaining at the site.

The site is now protected and includes a wildlife refuge. It has a visitor and education centre and its buildings and tunnels can be visited by arrangement.

## 7.10.8 | Aircraft

There is a long history of aircraft manufacture in Flintshire which extends from the around the time of the Second World War to the present day.

An aircraft factory was built at Broughton to manufacture the Wellington Bomber between 1937 and 1945. After this time, aircraft manufacture was suspended and the factory was used to build prefabricated aluminium housing to help recover after the War was over.

Aircraft manufacture was resumed in 1948 and continues today.

The factory is now operated by Airbus and is used to manufacture the wings for all Airbus civil aircraft, including the A380. The wings for the A380 are so large that they, unlike the wings for other aircraft, cannot be transported by air. Instead, the A380 wings are transported from the factory along the River Dee on a specially constructed barge to the docks at Mostyn where they are loaded onto ferries to be transported to other factories by sea.



### 7.10.9 | Other Industries

Many other industries have played their part in Flintshire's history, including soap manufacture, chemical manufacture, meat processing, gas works, oil works, brass manufacture, paper production and recycling and ship building.

Historical maps are a useful and interesting record of what took place and how the landscape looked in the past.

### 7.11 | Current Uses of Land

Flintshire is predominantly rural and approximately 80% of the County is within the rural area and the majority of land is used for agriculture.

A number of sand, gravel and limestone quarries operate in the rural areas of Flintshire, including Halkyn Mountain, Cadole and Hendre.

Industrial activity in Flintshire continues to take place in along the coastal areas of the County as it has in the past. Large scale industrial processes are concentrated along the River Dee and its Estuary, including Airbus, Tata Steel, ~~United paper mills~~ at Shotton, Toyota and Connah's Quay Power Station.

There are a number of industrial parks in Flintshire including Flint, Mold, Buckley and Deeside.

Deeside Industrial Park is the largest industrial park in the County and is of national importance. ~~Proposals to extend~~ **Extensions to** Deeside Industrial Park ~~to include~~ **including** areas of the former RAF Sealand military base ~~have recently been approved~~ **are currently underway.**

**Commented [RD50]:** Amended industry name

**Commented [RD51]:** Updated tense

**Commented [RD52]:** Substitute word

**Commented [RD53]:** Updated tense

### 7.12 | Development History and Controls

In developing a site, it is the responsibility of the developer to demonstrate that contamination present at the site may reasonably be addressed and that once developed, the site is suitable for the use proposed and is incapable of being formally determined as statutorily Contaminated Land in accordance with the provisions of Part 2A of the Environmental Protection Act 1990.

Where there is a possibility that the site put forward for development is affected by contamination, usually as a result of something that has taken place on or next to the site in the past, land contamination assessments may be required to determine the nature and extent of and the degree of risk associated with land contamination.

This is particularly important where the proposed development would introduce something or someone that would be sensitive to or whose health could be adversely affected by the presence of contamination.

Developing a site may introduce changes to a site that could result in land being considered Contaminated Land, where that land would not be considered Contaminated Land if the development did not take place.

Many applications are received for sites that may be affected by land contamination and the presence of contamination in the ground can present not only risks to health, structures and the environment but can also adversely affect or restrict the use of the land. The development of the land offers an opportunity to investigate and address those risks and to restore the beneficial use of the land.

The Council's development control and planning function ~~already~~ plays a key role in many aspects of pollution prevention and control. Land contamination is a material planning consideration and so it must be taken into account by the Council when assessing an application for planning permission and when deciding whether or not to grant planning permission. The Public Protection Service is consulted by the Planning Department over applications for planning permission and the discharge of planning conditions.

Commented [RD54]: Removed word

Since the last revision of the Contaminated Land Strategy was published in 2013 ~~2019~~, the Council has received approximately 6500 applications for either planning permission or for planning conditions to be discharged. Approximately 1300 of those applications have resulted in land contamination assessments and approximately 1300 of the planning permissions granted have included conditions requiring land contamination assessments or remediation works to be carried out.

Commented [RD55]: Updated statistics

By comparison, over the last 5 years, approximately 250 sites, including 5 historical landfill sites, have been formally investigated ~~inspected~~ or remediated as a direct result of this Strategy and Part 2A.

Commented [RD56]: Updated statistics

Commented [RD57]: Updated terminology

Once the development is complete or is occupied, unacceptable risks associated with land contamination should have been removed or reduced to an acceptable level and the land should not be capable of being determined as Contaminated Land in accordance with Part 2A of the Environmental Protection Act 1990.

Involving the Contaminated Land Officer as early as possible and continuing discussions as the application progresses creates an excellent opportunity to provide the Council with as much good quality information as possible in support of the application. It also provides an opportunity for the Council to provide you with as much information and advice as possible and can minimise delays and other problems at later stages. It can reduce the number of conditions imposed on the planning permission and can reduce the time it takes the officers dealing with the application to provide you with a response.

A guidance document has been prepared to ~~provide those~~ assist anyone applying for planning permission or those with planning permission with conditions requiring land contamination assessments and their representatives with an explanation of the information that the Council requires when considering applications for planning permission and the discharge of planning conditions.

Commented [RD58]: Substituted words

It also provides a summary of the information that is likely to be required, checklists and the answers to some frequently asked questions.

Commented [RD59]: Insert word

The document is available to download free of charge ~~in the Contaminated Land pages of the Council's website.~~ [www.flintshire.gov.uk](http://www.flintshire.gov.uk)

Commented [RD60]: Updated reference to website

Practices and processes can change over time and it is important to take this into account too as changes like this can affect the type of contamination that is likely to be found.

## 8.0 | Who deals with land contamination at the Council?

The Councils Environment Directorate **Community and Business Protection service** is responsible for ensuring that the Councils duty to identify, inspect and secure the remediation of land contamination is fully discharged.

**Commented [RD61]:** Update service area name

### 8.1 | Public **Community and Business** Protection

The Councils Public **Community and Business** Protection service is a part of the Environment Directorate **Planning, Environment and Economy portfolio** and is directly responsible for **dealing with land contamination related work**. This includes duties imposed on the Council by Part IIA **2A** of the Environmental Protection Act 1990 and other land contamination related legislation such as the Environmental Damage and Liability Regulations 2009 and the Environmental Permitting Regulations 2010.

**Commented [RD62]:** Update service area name

**Commented [RD63]:** Update service area and portfolio names

**Commented [RD64]:** Replace 'Part IIA' with 'Part 2A'

Land contamination is a highly complex interdisciplinary field involving the analysis of chemical, physical, biological and legal interactions between soil, rock, water, nature and society.

This is reflected in both statutory and non-statutory guidance which require that land contamination assessments are carried out by competent, accredited specialists. This means that land contamination assessments are specialist pieces of work and so the Public **Community and Business Protection service** employs a Contaminated Land Officer to lead on and direct land contamination issues.

**Commented [RD65]:** Update service area name

The Environment Directorate **Community and Business Protection service** and wider Council have a large number of policies, strategies and plans which have relationships and synergies not only between each other but also with the Contaminated Land **Inspection** Strategy.

**Commented [RD66]:** Update service area name

The Contaminated Land Officer works on the Contaminated Land **Inspection** Strategy, **including dealing with land contamination through the planning system** full-time, is responsible for the projects that are undertaken and provides specialist advice to other services within the Environment Directorate **Planning, Environment and Economy portfolio** and the wider Council.

**Commented [RD67]:** Insert word

**Commented [RD68]:** Insert reference to planning system

**Commented [RD69]:** Update portfolio name

None of the guidance or reference material applicable to land contamination provides a definitive test or value that may be applied to decide when risks are significant or when land may be considered as Contaminated Land.

The decision as to whether or not the possibility of significant harm being caused is significant is a regulatory decision to be made only by the Local Authority. It cannot be made by consultants, **agents** or any other person acting on its behalf.

**Commented [RD70]:** Insert word

Contact details for Environment Directorate **the Planning, Environment and Economy portfolio**, including the Contaminated Land Officer can be found in Appendix 1.

**Commented [RD71]:** Update portfolio name



## 8.2 | Planning

The Council's development control and planning function **already** plays a key role in many aspects of pollution prevention and control. Land contamination is a material planning consideration and must be taken into account when assessing an application for planning permission. For this reason, the Contaminated Land Officer works closely with the Councils Planning Service.

Commented [RD72]: Remove word

## 8.3 | Building Control

The potential for land to be affected by contamination and the measures required to protect developments and their occupiers against the adverse effects of land contamination are taken into account by Building Inspectors when assessing plans and inspecting construction work.

Specific conditions requiring work to be carried out can be imposed when passing building regulations plans.

## 9.0 | How will the Council deal with land contamination?

There are many organisations outside Flintshire County Council and many service areas within the Council whose work is directly affected by the Contaminated Land **Inspection** Strategy. This includes:

Commented [RD73]: Insert word

- Environment Agency
- Natural Resources Wales
- Welsh Government
- Cadw: Welsh Historic Monuments
- Clwyd-Powys Archaeological Trust (CPAT)
- North Wales Wildlife Trust
- Welsh Water
- Food Standards Agency
- Other Local Authorities

To ensure that the implementation of the Contaminated Land **Inspection** Strategy is consistent and effective, the Council has a number of established procedures and agreements in place which assist with the following tasks:

Commented [RD74]: Insert word

- Consultation
- Information Collection

- Prioritisation of site inspections
- Individual site inspections
- Reviews

## 9.1 | Consultation

### 9.1.1 | Consultation with Public Bodies

It is important that those with an interest in the Strategy are given opportunity to express their views and provide information.

Consultation with organisations affected by the implementation of the Strategy is important and close working relationships have become established with each one since the original strategy was first published in 2002.

### 9.1.2 | Consultation with private organisations and individuals

It is not only public organisations that are affected by the Contaminated Land Strategy. Many areas of land that may be affected by contamination are privately owned.

Land contamination has the potential to affect people's health and well-being, properties and financial situation and it is very important that this is understood. Changes to the Contaminated Land Statutory Guidance have been made so that regulators may take this into account when making their decisions.

Different people have different circumstances and different concerns. Their concerns are often based on their personal situations and perceived risks driven by fear, rather than actual risks. There are usually competing priorities between interested parties and each is likely to have a different perception of risk as a result of their own individual situation. For these reasons and others, no two site investigations are ever the same and communicating about land contamination, the investigation process and solutions can be emotionally charged and very complex.

The Council will have particular regard to this when assessing land contamination and individual strategies to direct how risks will be communicated to interested parties will be devised for each investigation.

Privately owned sites that have been identified for further inspection will be discussed with the individual owners who will be provided with detailed information and kept fully informed by the Contaminated Land Officer at every stage.

Those with an interest in a particular site will be notified of the Councils intention to investigate at the earliest opportunity. Early discussions will allow all parties to exchange information. This may resolve a number of issues raised by the prioritisation process and any desire to investigate or remediate the site voluntarily will be supported.

Consideration will only be given to securing the remediation of the land formally through the enforcement of Part 2A where it becomes apparent that necessary works will not be carried out voluntarily or within agreed timescales.

### 9.1.3 | Consultation with other service areas within the Council

The work of many of the service areas within the Council is affected by the Contaminated Land **Inspection** Strategy, particularly those responsible for land management and the maintenance of land including:

**Commented [RD75]:** Insert word

- Property and Estates
- Valuation and Assets
- Planning strategy
- Planning enforcement
- Development Control
- Regeneration
- Housing
- Waste management
- Legal
- Conveyancing
- Ecology and conservation
- Countryside Services

Communication between the individual service areas is essential as each one may be able to provide important information to another and a number of service areas may be involved when an investigation is planned and during an assessment.

The work of one service area may have implications for the Strategy and the conversely the Strategy may have implications for the work and future work of other service areas.

The Contaminated Land Officer meets regularly with representatives from other service areas to discuss on-going and planned work in each of their work areas.

### 9.1.4 | Council owned property

Flintshire County Council owns large areas of land and many buildings and other assets which may be affected by the Contaminated Land Strategy.

The **Public** **Community and Business** Protection service is not responsible for the management of Council owned land or property.

**Commented [RD76]:** Update name of service area

The Strategy will be applied impartially and sites in the Council's ownership will be considered in the same way that other sites will be.

It is likely that the Council will be responsible to bear the cost of any investigative or remedial work required at its own sites. The Council should also bear the cost of remedial works required at 'orphan' sites, where liability for land contamination cannot be attributed or apportioned to anyone else.

The cost of site investigations **land contamination assessments** and remediation depends on a number of factors including the size of the area affected and the type of contamination present and so can vary greatly from one site to another.

Commented [RD77]: Updated terminology

Private companies, individuals and property owners wishing to carry out voluntary assessments and voluntary acts of remediation will be encouraged and supported to do so, to **both** assist them and to reduce financial burdens on the taxpayer.

Commented [RD78]: Insert word

## 9.2 | Collection of information

A great deal of information has been gathered and recorded since the introduction of Part 2A of the Environmental Protection Act 1990 in 2001 and since the Contaminated Land **Inspection** Strategy was first published in 2002.

Commented [RD79]: Insert word

The information has been used to identify historical, natural and geological features, past land uses, areas which do not require any further assessment and some areas which will require further consideration.

The information has been gathered from a number of sources including:

- Historical maps
- Geological maps and memoirs
- Hydrogeological maps
- Coal authority records
- Local Authority records
- Environment Agency records
- Natural Resources Wales records
- Flintshire Record Office and County Archives
- Records of previous land uses
- Site plans
- Assessment of previous land uses
- Assessment of current land use
- Assessment of proposed land use

- Review of any previous investigations
- Anecdotal records
- Photographs
- Aerial photographs

The information is used to identify potential contaminants, pathways and receptors so that individual sites can be prioritised and subsequent stages of investigation can be planned and investigations to assess the potential pollutant linkages can be designed.

Some sites were investigated many years ago and some remedial works were carried out at others. In some cases, the information may be sufficient and in other cases it may not. It is important to remember that legislation, guidance, best practice and industry standards are updated and changed frequently. This means that investigations and reports from some time ago may be out of date and may need to be reviewed to make sure that they are up to date and consistent with current standards. If the report is very old, the information in it may be so out of date that it can't be used and the investigation may need to be started again from scratch.

### 9.2.1 | Complaints to the Council

The Council regularly receives complaints concerning land contamination and pollution. Most complaints concern escapes of fuel and domestic heating oil and some concern pollution caused by commercial premises or industry.

A guidance document explaining what to do if an oil leak is suspected is available free of charge on the Council's contaminated land webpages or from the Contaminated Land Officer.

In cases where land contamination has taken place at a point in the past or has recently taken place but does not continue, the Contaminated Land Officer may, after investigating the complaint, decide to take action in accordance with Part 2A of the Environmental Protection Act 1990.

In cases where land contamination has taken place and is continuing, the Contaminated Land Officer may, after investigating, decide to take action in accordance with other legislation for example, the Environmental Damage and Liability Regulations 2009 or other sections of the Environmental Protection Act 1990.

In any case, any person wishing to make a complaint will be asked to provide their name, address and telephone number, in accordance with the Public **Community and Business** Protection Enforcement Policy. This information will not be disclosed unless exceptional circumstances require it to be.

The Public **Community and Business** Protection Service does not accept or investigate anonymous complaints for a number of reasons not least that it reduces to reduce the number of malicious complaints that are received and . The Contaminated Land Officer cannot investigate allegations of statutory nuisance relating to land contamination where there is nobody identifiable for a nuisance to affect.

**Commented [RD80]:** Update name of service area

**Commented [RD81]:** Update name of service area

**Commented [RD82]:** Insert word

**Commented [RD83]:** Insert description

## 9.2.2 | Information volunteered to the Council

The Council uses a variety of sources to find information to use to inform land contamination assessments.

Sometimes, useful and important information is not revealed by these sources and sometimes the most useful information is held by other organisations and individuals.

Anecdotal and photographic information can provide context that other sources cannot. It is often information held by individuals who live and have lived and worked in a particular area and can remember important detail about a particular site, provide photographs and recall stories, memories and other informative and fascinating details.

One of the objectives of the Contaminated Land **Inspection** Strategy and the Part 2A regime is to provide a means of addressing unacceptable risks posed by land contamination to health and the environment.

Investigations will only be carried out where, following an assessment of risk, there is reasonable ground to suspect that unacceptable risks exist.

Any assessment or other action that the Council takes as a result of the implementation of the Contaminated Land **Inspection** Strategy and Part 2A will seek to ensure that the burdens faced by individuals, industry, commerce and society as a whole as a result are proportionate, manageable and compatible with the principles of sustainability and sustainable development.

Current and past owners and occupiers of land are able to carry out investigations voluntarily and the Contaminated Land Officer will encourage and support voluntary assessments and voluntary acts of remediation.

Commented [RD84]: Insert word

Commented [RD85]: Insert word

## 9.2.3 | How will the Council manage the information it collects?

Since the introduction of Part 2A **of the Environmental Protection Act 1990** in 2001, an extensive amount of information has been gathered and generated as a result of the prioritisation process, development of land, investigations and remedial work. The information includes historical maps, reports, records, photographs, paper and electronic records.

The management, storage, recording and disclosure of the information is coordinated and directed by the Contaminated Land Officer.

### Storage of information

Historical information such as plans, maps, anecdotes and photographs, site investigation reports, engineering plans and notes are usually retained as paper records. Some of the information held includes copies of records available at the County Record Office in Hawarden.

Contemporary and historical maps are stored electronically on a Geographical Information System (GIS).

Commented [RD86]: Insert full title of primary legislation

Some of the information held in paper records and gathered as a result of the prioritisation of sites is also recorded on the GIS. The information is recorded as points on the maps, for example closed landfill sites and historical features, with annotations, for example a grid reference or an explanation of the type of waste disposed, where necessary. The annotations do not include and personal, private or commercially sensitive data.

Each piece of information recorded on the GIS can be retrieved, overlain and compared with other information recorded on the GIS. The GIS is used to assist the prioritisation process and to identify and assess any potential pollutant linkages.

### Access to information at the Council

Access to the information recorded on the GIS in connection with the Contaminated Land Strategy is restricted and can only be edited and updated by the Contaminated Land Officer and the GIS manager.

Information stored on the GIS may be viewed, but not edited or changed, by a small number of officers working in other service areas within the Environment Directorate. For this reason, personal, sensitive and confidential information is not recorded on the GIS.

Other information about land contamination, including complaints is recorded in a separate electronic database that is used by Public **Community and Business** Protection. There are restrictions imposed on the database to limit who has access to the information that has been stored. Access to view and edit the information is limited to the Contaminated Land Officer and Pollution Control Officers and their administrative support staff who are aware of the requirements and implications of data protection legislation.

Some of the information held in paper records is confidential, commercially sensitive or legally privileged.

Access to this information is restricted to the Contaminated Land Officer and the Council's legal representatives.

Information stored on the GIS may be viewed, but not edited or changed, by a small number of officers working in other service areas within the Environment Directorate **Community and Business Protection service**. For this reason, personal, sensitive and confidential information is not recorded on the GIS.

Any requests to view paper or electronic records held in respect of land contamination and as a result of any stage of the implementation of the Contaminated Land **Inspection** Strategy will be directed to the Contaminated Land Officer. Personal, sensitive or confidential information will not be disclosed except in circumstances where there is a legal obligation to do so.

### Access to information by the Public

The Council has a duty to keep a Public Register of Contaminated Land which the public can view.

The Public Register includes information about land which has been investigated **specific regulatory actions, including land** formally determined as Contaminated Land and remediated. **The Register is**

**Commented [RD87]:** Update name of service area

**Commented [RD88]:** Update name of service area

**Commented [RD89]:** Insert word

**Commented [RD90]:** Update terminology

not a list of land where there is reasonable ground to suspect that land may be affected by contamination. It can be viewed free of charge on the Councils contaminated land web pages or at County Hall in Mold at [www.flintshire.gov.uk](http://www.flintshire.gov.uk) or by appointment at Ty Dewi Sant, Ewloe between the hours of 9am and 5pm by making an appointment with the Contaminated Land Officer.

Commented [RD91]: Insert updated address

For reasons of national security or commercial confidentiality, Part2A of the Environmental Protection Act 1990 sets out restrictions on the information that can be placed on the Public Register of Contaminated Land.

Other information is also available from the Council, for example environmental information which is not held on the public register. Any requests for the provision of information should be made in writing to the Council [FOI@flintshire.gov.uk](mailto:FOI@flintshire.gov.uk). Where possible and to avoid disappointment, delays and requests for further information, requests should include as much information about a site as possible for example, grid reference, address and specific questions. It is not necessary to explain; and the Council should not ask, why the information has been requested. There is not normally a charge for this service.

Commented [RD92]: Insert email address

It is important to understand that some information, as explained in the Environmental Information Regulations 1992 and the Freedom of Information Act 2000 will not be disclosed. The reasons why information has not been disclosed will be given.

### Buying and selling property and conveyancing

Commented [RD93]: Insert heading

When buying, selling or re-mortgaging a property, it is common to request information and to make enquiries about aspects of its history, events and features of its surroundings which may have or have had an effect on it.

Environmental searches usually rely on information such historical maps and trade directories to find out what the land has been used for in the past but without assessing risks to health or the environment.

Whilst during the sale or purchasing process, vendors or purchasers may be keen to secure a mortgage or please mortgage lender, it is important to remember that these issues may be raised again when the property comes to be sold or re-financed in future.

The Council can't tell someone whether to buy a property or not. The Council can provide factual information but not an opinion. Having done their research it'll be up to purchasers and vendors and their legal advisors to make such decisions.

The law in respect of land contamination, Part 2A of the Environmental Protection Act 1990, came into force in Wales in July 2001. This law introduced a detailed way by which land contamination could be regulated.

If a property was purchased before then, it is unlikely that the environmental searches carried out by a Solicitor would have included a search for potentially contaminated land.

If a property has been bought or sold since then and the purchaser or vendor was not told about any potential land contamination during the conveyance process or if the results of the environmental searches were not brought to their attention, they choose to contact a Solicitor for advice.



## 9.3 | Prioritisation

A large number of sites will be identified as land that may be affected by contamination. This does not mean that the land is affected by contamination or that the land may be considered as statutorily Contaminated Land.

Each site that is identified as potentially affected by land contamination will be considered for investigation in a prioritised manner to ensure that sites that pose the greatest risk to receptors are investigated first.

The prioritisation process will be followed to organise sites into the order that they are to be investigated **assessed** in. The process is flexible and allows for amendments to be made as the process is applied and develops. It also allows for sites to be investigated **assessed** as a matter of urgency should there be evidence that land contamination is causing actual harm. This applies to all sites regardless of their position in the prioritisation process. ~~and the list of prioritised sites.~~

**Commented [RD94]:** Updated terminology

**Commented [RD95]:** Updated terminology

**Commented [RD96]:** Remove end of sentence.

The prioritisation process will be carried out in 2 stages:

- Primary Prioritisation
- Secondary Prioritisation (Detailed Inspection)

At the end of the prioritisation process the sites that present the greatest potential risk to receptors will have been identified, risk assessed, scored and organised into an order for more detailed inspection so that sites with the highest risk are ~~investigated~~ **assessed** first.

**Commented [RD97]:** Update terminology

### 9.3.1 | Primary Prioritisation

At this stage, potential sources of contamination and potential receptors will be identified and the proximity of the receptors to the site will be considered.

The receptors will be organised into 3 categories:

- Terrestrial receptors
- Surface waters
- Groundwater

The terrestrial receptor group includes residential properties, allotments, schools, playgrounds, nursing homes, commercial and industrial properties, crops, livestock, non-aquatic ecosystems, domesticated animals and pets, wild animals subject to shooting or fishing rights and buildings of archaeological importance.

The surface waters group includes drains, streams, ponds, pools, canals, rivers and aquatic ecosystems.

The groundwater group includes aquifers and source protection zones.

Other receptors may be taken into account at a later stage in the assessment process.

The following diagrams explain how the proximity of the receptors will be considered and how this stage of the process will organise the sites into groups to be considered at the next stage.

For the purpose of the prioritisation process, where the answer to the questions is not known or is uncertain, the worst case will be assumed. Where the process places a site into one group for one category of receptor and into a lower group for another, the site will be placed into the higher priority group.

# Primary Prioritisation - Terrestrial Receptors

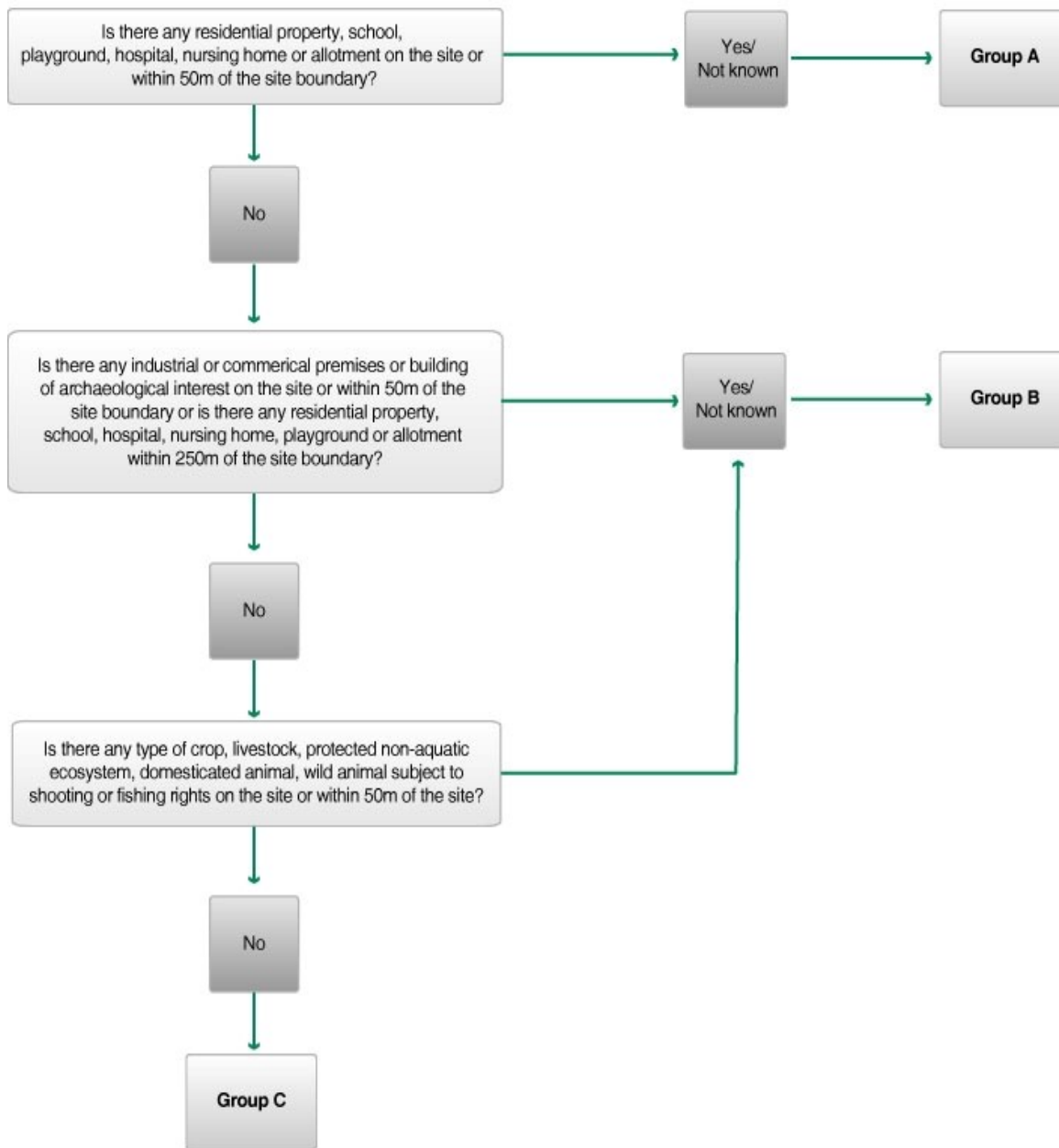

# Primary Prioritisation - Groundwater

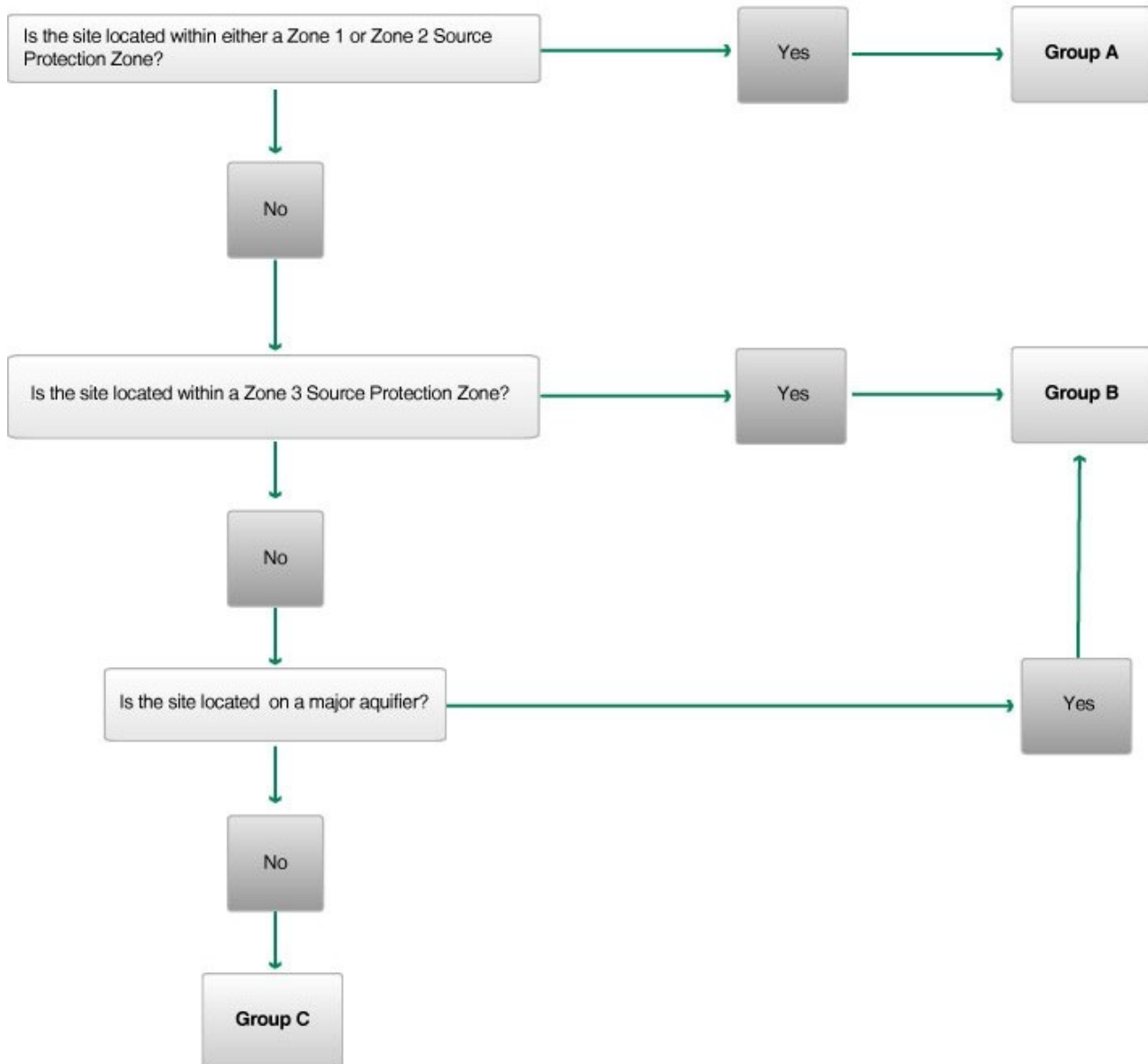

## Primary Prioritisation - Surface Water

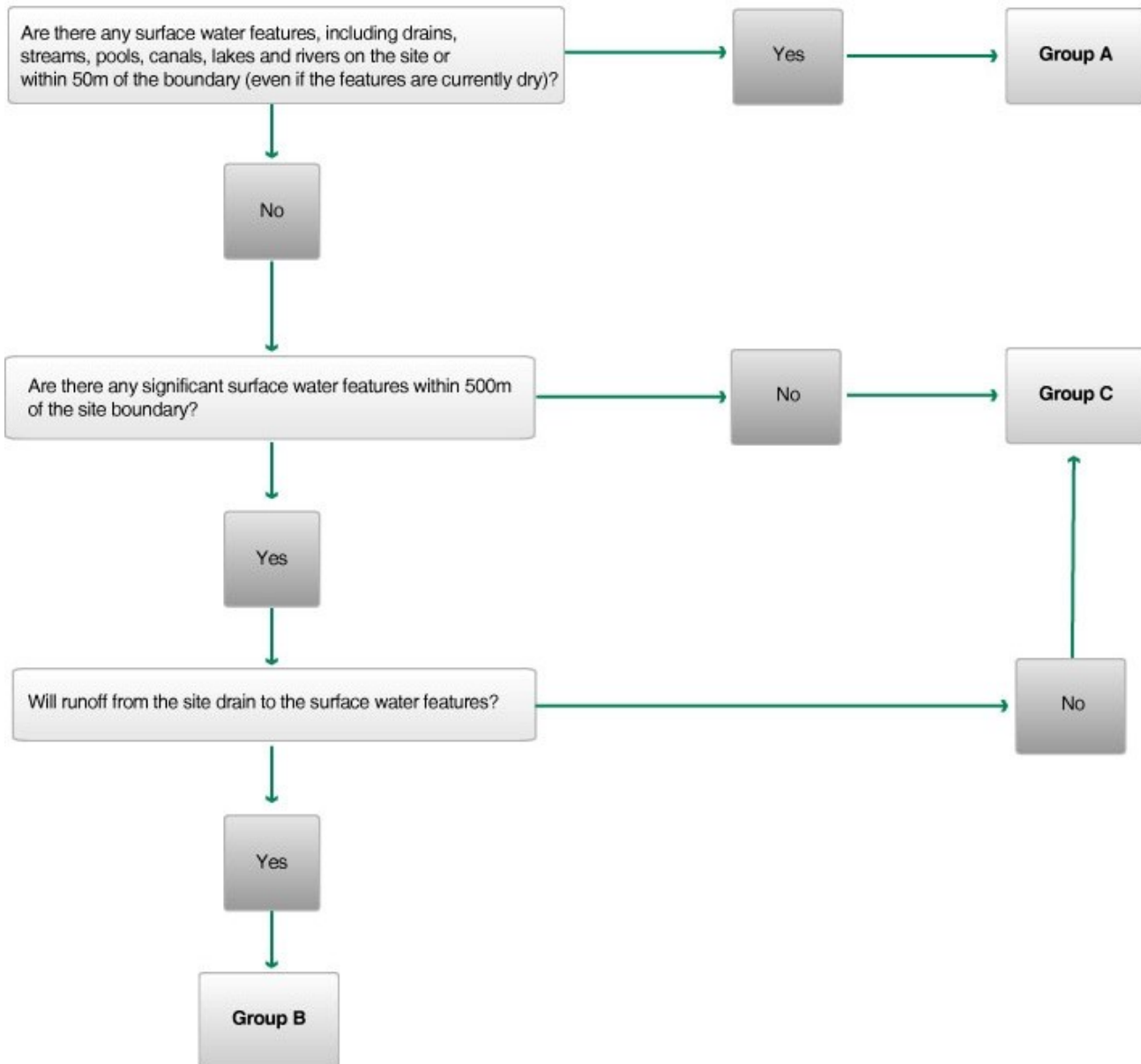

### 9.3.2 | Secondary Prioritisation (Detailed Inspection)

At this stage a more detailed assessment will be carried out.

Land contamination investigations and the assessment of risk are carried out in phases. There are usually 4 phases.

1. Desk Study (preliminary risk assessment)
2. Intrusive Investigation (detailed risk assessment)
3. Remediation
4. Verification

The outcome of the assessments carried out at each stage will determine if it necessary to progress to the next stage. For example, if the Desk Study finds that there are likely to be unacceptable levels of contamination present then it will be necessary to carry out an intrusive investigation. If the intrusive investigation finds that there are unacceptable risks as a result of the presence of the contamination then it will be necessary to carry out remediation.

The purpose of this phase of the assessment is to use a variety of sources of information to identify potential contaminants, pathways and receptors so that each site can be assessed and assigned a score depending on the significance of the receptors and an intrusive investigation can be designed to investigate the potential pollutant linkages.

**Sources of information include for example;**

- Historical maps
- Geological maps and memoirs
- Hydrogeological maps
- Coal authority records
- Local Authority records
- Environment Agency records
- Natural Resources Wales records
- Flintshire Record Office and County Archives
- Records of previous land uses
- Site plans
- Assessment of previous land uses
- Assessment of current land use
- Assessment of proposed land use
- Review of any previous investigations

Each individual site will be considered on its own merits. The individual characteristics and combinations of characteristics will be taken into account, including the significance of the receptors.

Most of the more highly populated areas of Flintshire are found around the same area as industry and it is likely that sites with greater potential risks to receptors will be found in these areas.

Surface waters and groundwater are valuable sources of potable water and are important to the economy. Surface waters also have economical importance and are valuable to leisure and amenity.

Protected ecosystems, wildlife and habitat sites, livestock, crops and wild animals subject to shooting or fishing rights are usually found in rural areas and areas away from settlements and industry. In some cases plants, animals and ecosystems themselves are reliant on the

contaminants in the ground. Some of the protected sites in the lead mining areas of Flintshire have been awarded protection because of the plants that grow there are rare and depend on elevated levels of lead and metals in the soil to thrive.

This has been taken into account and the following order of significance will be applied when considering receptors:

- Humans, pets, buildings, schools, allotments and playgrounds
- Controlled Waters – surface water and groundwater
- Protected ecosystems, crops, wild animals subject to shooting and fishing rights, livestock, and ancient monuments.

## 9.4 | Detailed inspection of individual sites

When the prioritisation process has been completed and an organised list of sites requiring more detailed inspection has been compiled; investigations to look into the potential risks to receptors can begin.

Detailed investigations and the assessment of risk will be carried out in stages. There will usually be 2 stages.

1. ~~Desk Study (preliminary risk assessment)~~ Preliminary Risk Assessment
2. ~~Intrusive Investigation (detailed risk assessment)~~ Detailed Risk Assessment

The outcome of the assessments carried out at each stage will determine if it necessary to progress to the next stage. For example, if the ~~Desk Study~~ preliminary risk assessment finds that there are likely to be unacceptable levels of contamination present then it will be necessary to carry out an ~~intrusive investigation~~ a detailed risk assessment. If the ~~intrusive investigation~~ detailed risk assessment finds that there are unacceptable risks as a result of the presence of the contamination then it will be necessary to consider whether or not the land will be formally determined as Contaminated Land and it may be necessary to carry out remediation.

Commented [RD98]: Update terminology

Once the detailed inspection is complete the Council will have sufficient understanding of the risks to receptors attributable to the presence of land contamination to be able to make regulatory decisions.

### 9.4.1| Desk Study (preliminary risk assessment)

The purpose of this phase of the investigation is to use a variety of sources of information to identify potential contaminants, pathways and receptors so that the intrusive investigation can be designed to investigate the potential pollutant linkages.

Sources of information include for example:

- Historical maps
- Geological maps and memoirs
- Hydrogeological maps
- Coal authority records
- Local Authority records
- Environment Agency records
- Natural Resources Wales records
- Flintshire Record Office and County Archive
- Records of previous land uses
- Site plans
- Assessment of previous land uses
- Assessment of current land use
- Assessment of proposed land use
- Review of any previous investigations

At this stage, a visual inspection of the site will also take place. Features on the surface of the ground can often be indicative of features and areas of contamination present under the surface for example:

- Areas of dead, dying or stressed vegetation
- Presence of plant species tolerant of particular substances
- Discolouration and staining of the ground
- Discolouration of water
- Abandoned structures
- Pipes
- Tanks
- Unusual odours
- Waste heaps

This phase of the investigation also provides an opportunity to identify any constraints or restrictions that may affect subsequent phases for example:

- Access points and emergency access
- Location of drains



- Location of water pipes
- Location of gas mains
- Nature and extent of concrete hard standings
- Old foundations
- Conservation designations such as SSSI, RAMSAR and SAC
- The presence of protected species, geology or archaeology
- Highway limitations or height restrictions
- Occupation of the site

Once the potential contaminants, pathways, receptors and potential pollutant linkages have been identified, these are used to put together a Conceptual Site Model.

The Conceptual Site Model is a compilation of all the potential pollutant linkages. It is a very important part of the land contamination assessment process and although it can be expressed as a table, a diagram or both, it is important that it is presented in a format that can be easily followed through and back through each phase.

It is used to understand and identify potential pollutant linkages and interactions between them, to design the intrusive investigation, to inform the detailed risk assessment and to design and verify remedial works.

#### 9.4.2 | ~~Intrusive Investigation~~ Detailed Inspection

It is expected that an ~~intrusive investigation~~ a Detailed Inspection will be carried out when the preliminary risk assessment has found that there are potential pollutant linkages and potentially unacceptable risks present.

Phase 1 of the assessment must be sufficient to show that the potential risks have been thoroughly understood and this means that a high level of confidence in the preliminary risk assessment is required to demonstrate that any other outcome is acceptable.

The ~~investigation~~ inspection itself will be designed on a site specific basis, taking into account the individual characteristics and relationships between them to look into the potential pollutant linkages and discover whether or not they exist.

Depending on the level of detail and risk assessment required, it may be necessary to carry the investigation out in phases. Some types of contaminants, for example gasses and vapours, are affected by temperature and weather conditions and so some investigations will also need to be carried out over many months to take account of seasonal variations in groundwater levels, air pressure, rainfall and temperature.

The scope of the investigation will depend on the contamination suspected to be present and the scale may range from the collection of a few shallow samples of soil to the continuous analysis and monitoring of potentially explosive vapours in boreholes drilled deep into the bedrock.

Commented [RD99]: Update terminology

Commented [RD100]: Update terminology

In any case, samples will be taken and sent to a suitably accredited laboratory for analysis. Depending on the type of contamination that the investigation **Inspection** is looking for, samples of soil, rock, made ground, water, gasses and vapours may be taken. All samples will be collected using the most appropriate technology or method. In some cases it will be necessary to use specialist equipment such as drilling rigs, probes and analysers to recover samples and install equipment such as monitoring wells. Where necessary, the services of specialist consultants with the equipment necessary will be purchased. The cost and availability of specialist equipment will be taken into account by the Contaminated Land Officer when designing the investigation **Inspection**.

**Commented [RD101]:** Update terminology

All samples will be handled, transported, stored and preserved correctly so that the quality of the samples and ultimately the results of the analyses performed on them are not compromised.

**Commented [RD102]:** Update terminology

Land contamination assessments at every stage, including the intrusive investigation stage, will be carried out in accordance with current UK guidance and best practice. See Appendix 2.

Current and past owners and occupiers of land are able to carry out investigations voluntarily and the Contaminated Land Officer will encourage and support voluntary assessments and voluntary acts of remediation.

### 9.4.3 | Powers of Entry

Privately owned sites that have been identified for further **Detailed** inspection will be discussed with the individual owners or occupiers who will be provided with detailed information and will be kept fully informed by the Contaminated Land Officer at every stage.

**Commented [RD103]:** Update terminology

In the event that an investigation **Inspection** will not be undertaken voluntarily or a landowner or occupier will not cooperate with the Council or refuses to allow access to their property, the Council will consider using formal means of carrying out the investigation **Inspection**.

**Commented [RD104]:** Update terminology

**Commented [RD105]:** Update terminology

The Environment Act 1995 (Section 108), allows the Council statutory Powers of Entry to enter property for the purpose of undertaking visual and intrusive site investigations **this**.

**Commented [RD106]:** Simplified sentence

The Council will consider using the powers of entry when other reasonable attempts to access a site have been unsuccessful and when,

- There is reasonable ground to suspect or where it is known that a pollutant linkage exists at the site,
- It is likely that the contaminant is present,
- The receptor is actually present or is likely to be present as a result of the current use of the land.

The powers of entry will not be considered when,

- Detailed information concerning the condition of the land has already been provided and the Council can make a decision as to whether or not the land meets the statutory definition of Contaminated Land,

- Information is offered and provided to the Council within a reasonable and specified time.

#### 9.4.4 | Risk Summaries

Once the ~~detailed assessment~~ **Detailed Inspection** of a site is complete, the Council may decide to produce a risk summary to explain the outcome of the assessment and the Councils understanding of the risks to receptors and any other issues associated with the site that are considered to be relevant.

**Commented [RD107]:** Update terminology

The risk summary will not be a technical document. It will be written so that the Councils understanding of the pollutant linkages and risks associated with the presence of contamination, the potential impacts and likelihood that the impacts may take place, the times over which the impact and risk may take place, an explanation of anything that the Council is uncertain about, an explanation of the context of the risks and an explanation of the potential solutions are set out and can be understood by the layperson.

#### The Council is unlikely to produce a risk summary where:

- The land will not be determined as ~~statutorily~~ Contaminated Land
- Land for which the prioritisation process has identified detailed inspection will be necessary but which has not yet been assessed
- Contaminated Land determined as such before the Contaminated Land Statutory Guidance 2012 was introduced.

Further information about land which has been ~~investigated~~ **inspected**, formally determined as Contaminated Land and remediated is recorded in the Councils Public Register of Contaminated Land. The Public Register can be viewed free of charge on the Councils contaminated land web pages ~~at~~ [www.flintshire.gov.uk](http://www.flintshire.gov.uk) or by making an appointment with the Contaminated Land Officer.

**Commented [RD108]:** Update terminology

**Commented [RD109]:** Update website link

#### 9.4.5 | Special Sites

Land contamination at some sites may be found to be affecting Controlled Waters such as Rivers, Lakes, Streams and Groundwater. These sites are known as Special Sites and will be referred to Natural Resources Wales.

If during any part of the prioritisation or assessment process it becomes apparent that a site may be considered a Special Site, the Council will notify Natural Resources Wales.

If it is the case that the site is considered a Special Site, the Council will make arrangements with Natural Resources Wales for Natural Resources Wales to proceed with the assessment of the site.

#### 9.4.6 | What happens when a contamination affects another County?

Flintshire shares its boundary with Cheshire, Wrexham, Denbighshire and Wirral. It is possible that the prioritisation process will identify sites that are at, cross or are very close to the border with other Counties.

If a detailed inspection of a site at, across or close to the boundary with another Local Authority is found to be necessary, Flintshire County Council will notify the Local Authority responsible for the area in which the affected receptor is located.

In the event that during the course of an assessment, pollutant linkages affecting receptors on both or either side of the boundary are found, Flintshire County Council will notify the Local Authority responsible for the area in which the affected receptor is located.

If it is the case that urgent investigations **assessments** are required, Flintshire County Council will notify the appropriate Local Authority without undue delay.

Commented [RD110]: Update terminology

In any case, the local authorities, including Flintshire County Council will cooperate and agree a mutually acceptable scope for each stage of the investigation **assessment** and where found to be necessary, for remedial works. Each local authority will identify and agree each of their individual responsibilities.

Commented [RD111]: Update terminology

For the purpose of regulation and enforcement, the Local Authority responsible for the area in which the contaminant is present will assume the role of regulator and enforcing authority, in agreement that the arrangement is without prejudice to statutory guidance, legislation and any legal advice received.

The same will apply to sites at, crossing or very close to Flintshire's border with Cheshire and Wirral. Although the Part 2A regimes and Contaminated Land Regulations and statutory guidance are separate for England and Wales the principles and processes are fundamentally and effectively the same.

In the unlikely event that there is a dispute, the Welsh Government will be asked to intervene. In the unlikely event that there is a dispute with a local authority in Cheshire or Wirral, the Welsh Government or the Secretary of State will be asked to intervene.

## 9.5 | How will the process be reviewed?

The implementation of the Contaminated Land **Inspection** Strategy is a continuous process and over time it is likely that some of the factors that were considered during the prioritisation process will change for some sites.

Commented [RD112]: Insert word

Where any changes are considered relevant to the Strategy and to the priority of the site, they will be taken into account and a review of the prioritisation of the site will be carried out.

The changes that may affect the priority of a site include:

- Proposed or actual changes to the use of the surrounding land
- Proposed changes, including development, to the use of the site
- Unforeseen events such as accidents, spillages, leaks and flooding
- Reports of health effects which could be connected with the site

- Verifiable reports of unusual or abnormal conditions on a site
- New information that comes to light about a site

In accordance with Part2A of the Environmental Protection Act 1990, the Council has a duty to make occasional inspections of the Flintshire area to identify land which may be affected by contamination.

The implementation of the Contaminated Land **Inspection** Strategy, including the prioritisation process is therefore continuous and will be reviewed at regular intervals to ensure that:

**Commented [RD113]:** Insert word

- Changes to legislation and guidance are taken into account
- The Strategy and procedures comply with legislation
- The prioritisation process is effective
- The objectives of the Strategy are met
- Any improvements that could be made are identified
- A satisfactory level of service is provided to customers

If a review finds that changes are necessary then the Council will publish a revised Contaminated Land **Inspection** Strategy to reflect them.

**Commented [RD114]:** Insert word

### 10.0 | When will this take place?

The implementation of the Contaminated Land Inspection Strategy is an on-going process and as new information becomes available or the circumstances at a particular site change, the priority awarded may also change.

During the prioritisation process, many sites will either be developed or investigated voluntarily and the list of prioritised sites will evolve.

For these reasons, it is not possible to state a date by which all sites will have been considered by the prioritisation process, investigated or remediated.

The following table explains how long it is anticipated that the most important stages of the Strategy will take to complete.

**Commented [RD115]:** Remove table to align with guidance

**Table 3: Tasks and Timescales**

What will be done?	By when?
Consultation — revision of Contaminated Land Inspection Strategy	March 2019 — Completed
Adoption and publication of Strategy	June 2019

Review Public Register of contaminated Land and publish risk summaries where appropriate	June 2019
Identification of land which may be affected by contamination	On-going
Record data on GIS	On-going
Review Strategy	March 2019
Report to Cabinet	April 2019
Primary Prioritisation	Under review 2019
Secondary Prioritisation	Under review 2020
Site Investigations	On-going
Investigate sites posing imminent risk	On-going
Publish risk summaries	Within 3 months of completion of assessment
Review strategy and prioritisation process	On-going 2019-2020

To assist the planning process and to minimise delays in deciding whether or not planning permission may be granted, the Pollution Control section will respond to every consultations received from the Planning Department **service** within 19 working days.

Complaints alleging land contamination will be responded to within 1 working day **5 working days** and will be investigated in accordance with the Public Protection **Service Community and Business Protection** Enforcement Policy.

**Commented [RD116]:** Substitute word

**Commented [RD117]:** Substitute of number

**Commented [RD118]:** Update name of service area

## Appendix 1 | Useful Contacts

Contaminated Land Strategy Contacts	
Principle Contact:	Contaminated Land Officer
Address:	Pollution Control Flintshire County Council Ty Dewi Sant   Ewloe   Flintshire   CH5 3FF
Telephone:	01352 703400
Email:	<a href="mailto:pollution.control@flintshire.gov.uk">pollution.control@flintshire.gov.uk</a>

Contact:	
Address:	Community and Business Protection Pollution Control Section Flintshire County Council Ty Dewi Sant  Ewloe  Flintshire   CH5 3FF
Telephone:	01352 703330
Email:	<a href="mailto:pollutioncontrol@flintshire.gov.uk">pollutioncontrol@flintshire.gov.uk</a>
<b>Planning Department Contacts</b>	
Contact:	Development Control General Enquiries
Address:	Flintshire County Council Ty Dewi Sant   Ewloe  Flintshire   CH5 3FF
Telephone:	01352 703234
Contact:	Planning Strategy General Enquiries
Address:	Flintshire County Council Ty Dewi Sant   Ewloe  Flintshire   CH5 3FF
Telephone:	01352 703213
<b>Building Control Contacts</b>	
Contact:	Building Control General Enquiries
Address:	Building Control Flintshire County Council Ty Dewi Sant   Mold   Flintshire   CH5 3FF
Telephone:	01352 703647

## Appendix 2 | Reference material and Standards

None of the guidance or reference material applicable to land contamination provides a definitive test or value that may be applied to decide when risks are significant or when land may be considered as Contaminated Land.

The following list indicates a number of useful reference documents. The list is not exhaustive.

- British Standards Institution (2011) Investigation of Potentially Contaminated Sites, Code of Practice, BS: 10175:2011
- British Standards Institution (2010) Amendment 2: Code of Practice for Site Investigation, BS5930:1999+
- British Standards Institution (2007) Specification for Topsoil and Requirements for Use, Code of Practice, BS: 3882:2007
- British Standards Institution (2002) Soil Quality, Sampling. Guidance on sampling techniques, Code of Practice BS: 10381:2002
- CIRIA Report C665 (2007) Assessing Risks Posed by Hazardous Ground Gases to Buildings
- CL:AIRE (2011) Definition of Waste: Development Industry Code of Practice.
- Department of the Environment (1995) Industry Profiles
- Environment Agency (2010) Guiding Principles for Land Contamination
- Environment Agency (2004) Model Procedures for the Management of Land Contamination (CLR 11)
- Environment Agency (2006) Remedial Targets Methodology, Hydrogeological Risk Assessment for Land Contamination
- Environment Agency (2010) Petroleum Hydrocarbons in Groundwater: Supplementary Guidance for Hydrogeological Risk Assessment
- Environment Agency (2002) Technical Advice to Third Parties on Pollution of Controlled Waters for Part IIA EPA 1990
- Environment Agency (2005) Science Report P5-080/TR3, The UK Approach for Evaluating Human Health Risks from Petroleum Hydrocarbons for Soil



- Environment Agency (2003) MCERTS Performance Standards for Laboratories Undertaking—Chemical Testing of Soil
- Environment Agency (2009) Science Report SC050021/SR2, Human Health Toxicological Assessment of Contaminants in Soil, Background to the CLEA Model
- Environment Agency (2009) Science Report SC050021/SR3, Updated
- Environment Agency (2009) CLEA Software Handbook Version 1.04
- Environment Agency, National House Building Council (2008) Guidance for the Safe Development of Housing on Land Affected by Contamination, R&D Publication 66:2008
- Health and Safety Executive (1991) Protection of Workers and the General Public during the Development of Contaminated Land
- Health and Safety Executive (2012) Lead and You—Working Safely with Lead
- Raybould JG, Rowan DL & Barry DL, 1995, CIRIA Report C150, Methane Investigation Strategies
- Welsh Assembly Government (2012) Statutory Guidance on Contaminated Land
- Wilson S, Oliver S, Mallett H, Hutchings H & Card G, 2007, CIRIA Report C665, Assessing Risks Posed by Hazardous Ground Gases to Buildings
  - British Standards Institution (2013) Guidance on Investigations for Ground Gas. Permanent Gases and Volatile Organic Compounds (VOCs), BS: 8576:2013

- Welsh Government (2012) Statutory Guidance on Contaminated Land
- Welsh Government (2021) Planning Policy Wales edition 11
- Department of the Environment (1995) Industry Profiles
- Environment Agency (2020) Land Contamination Risk Management Guides 1-4 (as applicable to Wales and Natural Resources Wales specification for the use of these documents in Wales). British Standards Institution (2017) Investigation of Potentially Contaminated Sites, Code of Practice, BS: 10175:2011+A2
- British Standards Institution (2020) Amendment 2: Code of Practice for Site Investigation, BS5930:2015+A1:2020
- CIRIA Report C735 (2014) Good practice on the testing and verification of protection systems for buildings against hazardous ground gases
- CL:AIRE (2020) Professional Guidance: Comparing Soil Contamination Data with a Critical Concentration

- CL:AIRE (2021) Good Practice for Risk Assessment for Coal Mine Gas Emissions
- Department of the Environment (1995) Industry Profiles
- Environment Agency (2010) Guiding Principles for Land Contamination
- Environment Agency (2021) Land Contamination Risk Management (LCRM)
- Environment Agency (2004) Guidance on the management of landfill gas
- Environment Agency (2006) Remedial Targets Methodology, Hydrogeological Risk Assessment for Land Contamination
- Health and Safety Executive (1991) Protection of Workers and the General Public during the Development of Contaminated Land

**Commented [RD119]:** Updated references list

## Glossary

**Hydrology** is the name given to the study of the movement and distribution of water around the World including, rivers, lakes, streams, seas and oceans. It is also a term used to describe surface water features and the way in which they move.

**Hydrogeology** is the name given to the study of water beneath the ground in soil and rocks and in aquifers. It is also a term used to describe groundwater features and the way in which water moves under the ground and in aquifers.

**Aquifer** is the name given to water-bearing layers of rock under the ground from which groundwater can be extracted. Aquifers can be classified according to their properties and how important a source of drinking water they are.

**Groundwater** is the name given to water found in layers of rock under the ground and in the tiny gaps between particles in the soil, called soil pore spaces.

**Tailings** are made up of the left over materials after the valuable part of the ore has been separated from the materials with little value.

**Spoil** heaps are piles of overburden and other wastes. They are not the same as tailings.

**Overburden** is the term used to describe the rock and soil overlying the ore that is to be mined.

**Remediation** is the process of addressing unacceptable risks associated with the presence of contamination. ~~The purpose of remediation is to either remove the risks or reduce them.~~

Mae'r dudalen hon yn wag yn bwrpasol

## Summary of updates to Contaminated Land Inspection Strategy

2017	2023
Page 2	Update address to Ty Dewi Sant
Page 2	Update portfolio name
Page 3	Change 'investigations' to 'assessments'
Page 3 (and Pages 49, 50, 51, 52 & 54)	Update terminology relating to stages of assessment - 'desk study' to 'preliminary risk assessment' and 'intrusive investigation' to 'detailed risk assessment'.
Page 3	Amend text to align references to stages of assessment.
Page 3	Update terminology – replace 'remove or reduce those risks to acceptable level' with 'address those risks'.
Page 5	Update terminology – replace 'investigate' with 'inspect' or 'assess'
Page 6	Add bullet point 'To enhance and protect the natural environment and biodiversity'
Page 6	Add bullet point 'To take account of the effect of climate change on the lifespan of remediation measures'
Page 6	Update bullet point with references to current corporate plans and policies. Remove outdated and replace with current.
Page 6	Update terminology. Replace 'investigate' with assess.
Page 7	Add 'where there is reasonable ground to suspect' to 4.1.
Page 7 (and Pages 35, 37, 40 & 41)	Update terminology – change Contaminated Land Strategy to Contaminated Land Inspection Strategy.
Page 8 (and Pages 41 & 42)	Clarify purpose of Public Register – add 'specific' to 'actions'.
Page 8 (and Page 40)	Add reference to (Part 2A of) Environmental Protection Act 1990 in 5.0
Page 8	Add 'professionally accredited'

Page 14	Update references to corporate plans and policies. Replace outdated with current in 6.0
Page 14 (and Pages 38 & 43)	Update terminology – replace ‘investigate/investigated’ with ‘assess/assessed’.
Page 15	Update portfolio name on map legend (FCC N Wales context map)
Page 21	Include reference to NRW
Page 21	Add reference to new legislation – ‘Conservation of Habitats and Species Regulations as the many of the designated environmental conservation sites including the River Dee, are sensitive to the presence of phosphates’.
Page 22	Amend reference – replace ‘Environment Agency’ with NRW
Page 23	Updated figures for numbers of listed buildings, historical landscapes, scheduled ancient monuments and conservation areas.
Page 27	7.10.2 removed words ‘open cast’.
Page 31	7.10.8 removed text ‘The wings....by sea’.
Page 32	Updated reference to Deeside Industrial Park to reflect Northern Gateway development in 7.11
Page 33	Updated figures to reflect number of planning applications and number of sites assessed through Part 2A.
Page 34 (and Pages 38, 39 & 41)	Updated portfolio name.
Page 55	Removed Table 3 – timescales neither applicable nor relevant to on-going work or required by Statutory Guidance.
Appendix 1	Updated addresses to Ty Dewi Sant
Appendix 2	Updated list of basic references



Mae'r dudalen hon yn wag yn bwrpasol



# Eitem ar gyfer y Rhaglen 7



## CABINET

<b>Date of Meeting</b>	Tuesday 16 <sup>th</sup> January 2024
<b>Report Subject</b>	North East Wales Archive Project
<b>Cabinet Member</b>	Cabinet Member for Education, Welsh Language, Culture & Leisure
<b>Report Author</b>	Chief Officer (Education and Youth Services)
<b>Type of Report</b>	Strategic

### **EXECUTIVE SUMMARY**

All Councils have legislative duties to collect, preserve and make accessible documents of historical importance. Flintshire (FCC) and Denbighshire (DCC) Councils are facing several challenges in relation to the existing archive buildings which are not suitable for purpose, lack storage capacity and are costly to operate.

Traditionally, archive services have had a very narrow user base, meaning their rich collections that offer so much potential for supporting education, well-being, and community engagement, are under-utilised. This is particularly relevant in the post-Covid context and so the service needs to develop the capacity to reach out and engage with more diverse audiences. This would help to ensure the service's long-term future and maximise the benefits from the extensive archive materials for the benefit of all sections of our society.

The archive services of Flintshire and Denbighshire Councils have been working collaboratively over the last few years under a Memorandum of Understanding, to share skills and resources to create a more sustainable and improved archive service for the region. This resulted in the launch of a single shared service, North East Wales Archives (NEWA), in April 2020, working over the Councils' 2 current sites – The Old Rectory in Hawarden and Ruthin Gaol.

To maximise the impact of archive services on our communities and extend their reach across Flintshire and Denbighshire, and to address major deficiencies in the current archive buildings in Hawarden and in Ruthin, both Councils have a shared ambition to build a new, state of the art archive facility for NEWA on the County Hall campus, next to Theatr Clwyd. This would bring the Flintshire and Denbighshire collections together in a single location. This new building would also act as a hub in a 'hub and spoke' model, which would provide digital access to the archive

materials through access points in libraries and other public buildings to widen participation across both Flintshire and Denbighshire.

NEWA, with the support of both Councils, submitted a bid to the Heritage Horizons pot of the National Lottery Heritage Fund in February 2021 and narrowly missed out on being awarded funding. Whilst there was no negative feedback on the content and quality of the bid, and we were actively encouraged to make a new application to the Wales National Lottery Heritage Fund. A new grant application has now been submitted to the Lottery Heritage Fund and we should hear whether we have been granted funding or not by the end of March 2024.

The move to a single building enables NEWA to combine and better utilise its resources, protects the archive services in both Councils and enables us to deliver an exciting activity plan that will introduce archives to a wider and more diverse audience, making a positive contribution to the learning and wellbeing of our residents.

## RECOMMENDATIONS

1	Informal Cabinet notes the submission of a further grant application to the NLHF Wales for £7.336m by North East Wales Archive (NEWA) on 15 November 2023.
2	Informal Cabinet notes the outcome of the grant application will be known by the end of March 2024, and that if the bid and the project are successful, then the service delivery model will be fully operational by the end of the financial year 2027-28.
3	Informal Cabinet notes the challenges faced by the project since 2021 and the ongoing developments, including the impact on the potential costs of the project in light of inflationary pressures in the current market conditions.

## REPORT DETAILS

<b>1.00</b>	<b>EXPLAINING THE NORTH EAST WALES ARCHIVE PROJECT</b>
1.01	Both Councils have legislative duties to collect, preserve and make accessible documents of historical importance. Flintshire (FCC) and Denbighshire (DCC) Councils are facing several challenges in that regard relative to the existing archive buildings, which are not suitable for purpose, lack storage capacity and are costly to operate. NEWA also has a very narrow user base, meaning their rich collections that offer so much potential for supporting education, well-being and community engagement is underutilised. The service also lacks the capacity to reach out and engage with wider more diverse audiences; This needs to be expanded and widened to ensure the service's long-term future, and to maximise the benefits from the extensive archive materials held.

1.02	<p>The Archive Services of both Councils have been working collaboratively over the last few years, to share skills and resources to create a more sustainable and improved archive service for the region. This resulted in the launch of a single shared service – NEWA, in April 2020, initially over 2 sites – The Old Rectory in Hawarden &amp; Ruthin Gaol. A Memorandum of Understanding is in place and the project is overseen by a Project Board comprising of two senior Council Managers from FCC and DCC, two Cabinet members, one from each Council, the NEWA Service Manager and is supported by a part time Project Manager. The Project Board meets regularly and has clearly defined terms of reference.</p>
1.03	<p>This project aims to provide a sustainable and improved archive service for Flintshire and Denbighshire via:</p> <ol style="list-style-type: none"> <li>1. the creation of a single shared service, to formalise the existing joint working relationship between and Flintshire and Denbighshire, which is known as NEWA;</li> <li>2. the construction of a new purpose built net zero carbon building (repository to Passivhaus specification), next to Theatr Clwyd Mold, to house both the physical archives &amp; the new service operations</li> <li>3. an associated activity plan which will make the collections; accessible to a wider and diverse audience.</li> </ol>
1.04	<p>The joint service had submitted a NLHF Heritage Horizons Grant bid in February 2021, to fund both the construction of a new purpose built Passivhaus building adjacent to Theatr Clwyd in Mold and an associated 3-year activity plan. This would have provided a repository to safeguard the collections of both authorities and provide some 30 years of future proofing in respect of storage capacity, as well as enabling the staff to co-locate and benefit from the wider skills within the amalgamated team and have capacity to provide an outreach provision within both counties.</p>
1.05	<p>The initial bid requested £11.588 million from the NLHF with match funding agreed by both local authorities – FCC £3,027,782m and DCC £2,034,521 The FCC match funding contribution was approved by Cabinet in November 2019.</p>
1.06	<p>During July 2021, the NLHF advised that the Joint Archive funding application had been unsuccessful. The Joint Archive Service Manager was advised that the application was the last to be declined and encouraged us to present a new funding bid to the National Lottery Grants for Heritage (Wales), as the Welsh team were supportive of the ambitious project; but the maximum grant value they could offer would be £5 million.</p>
1.07	<p>The Joint Archive Project Board agreed that this new funding opportunity should be progressed and that the site identified in Mold still represented the preferred site for NEWA, given its proximity to Theatr Clwyd and the opportunities for joint working/shared footfall, and the strategic positioning with potential to provide a gateway to North East Wales, but equally it</p>

	<p>recognised that the ambitions for the project will need to be pared back in order to meet the smaller funding envelope.</p>
<p>1.08</p>	<p>The Project costs to deliver the building and the activity plan needed to be reduced from the previous estimated cost of £17.2m, to reflect the reduced funding anticipated to be available. In terms of the building, which represents most of the cost, a process of reverse engineering was undertaken, and the following project changes were identified to reduce costs: -</p> <ul style="list-style-type: none"> <li>• The environmental standard for the building was changed from passivhaus to net zero carbon in operation. Whilst passivhaus would have been the optimum standard, a net zero carbon building provides an exceptionally high environmental standard whilst reducing capital costs. (The repository was still to be built to Passivhaus specification, although not accredited as such, to ensure that the service benefits from the operational savings associated with providing the controlled environment required).</li> <li>• Discussions with Theatr Clwyd had presented opportunities to utilise their excellent exhibition facilities rather than have our own, so this was removed from the building design.</li> <li>• The repository had the same overall capacity but includes shelving which is future proofed for 20 years, after which time, shelving for the further 10 years of future proofing can be purchased and installed.</li> <li>• There was a rationalisation of room sizes within the building, which included the self-service area, search-room, staff areas, storage areas and digitisation space, which in conjunction with the use of exhibition facilities within Theatr Clwyd when required, still accommodated the enhanced service delivery planned. The changes outlined resulted in the building size being reduced from 3,000m<sup>2</sup> to 2,100m<sup>2</sup>, which represented a significant cost saving.</li> <li>• The activity plan remained intact and maintained the project's ambition to engage with wider and diverse audiences. The NEWA team had analysed the costs associated with the activity plan and worked with delivery partners to reduce them.</li> <li>• The appointment of a Digital Archive Assistant paid for via NEWA revenue budgets had eliminated the need for digitisation costs from the project.</li> <li>• Student placement costs were eliminated, as funding is available via the further education and higher education sector.</li> </ul>

	<ul style="list-style-type: none"> <li>• Apprenticeship costs were removed, as these would be included as part of community benefits element of the construction framework.</li> <li>• The NEWA team would be used to develop and deliver the activity plan rather than hiring costly consultants. This would include a skills analysis and a restructure of the team, supported by a targeted training and mentoring programme, (complete by the time that the new facility is delivered), which would enable the refocused NEWA team to deliver the activities.</li> <li>• An accelerated construction timetable, to reduce the level of inflation on building materials. This would necessitate the RIBA 4 technical design process being undertaken at risk, whilst the NLHF are assessing the submission at the end of the development phase, (RIBA 3), before offering a contract for the delivery phase, (the assessment is for reassurance purposes not a competitive process). As RIBA stage 4 activities would have been commenced prior to the award of the NLHF delivery phase contract, they are ineligible for funding. For the purposes of the funding application the RIBA 4 costs, would be ring fenced and not included in the project costs of the funding application, and an equivalent value of match funding would likewise be omitted from the NLHF application, to meet the RIBA 4 costs.</li> </ul>
1.09	<p>Given the project had been able to reduce costs significantly, a new bid was submitted to the NLHF Wales during November 2021 requesting the maximum grant of £5 million. Regrettably in March 2022 the funding application was withdrawn, as delays to the theatre project were impacting on the availability of the proposed archive site, which was putting the proposed joint archive project at risk. NLHF advised that they were still supportive of the project and would welcome a future funding application.</p>
1.10	<p>Since the original business case was written, world events and economic forces have resulted in significant inflationary increases which have had a major impact on construction costs. Despite the reverse engineering which has been undertaken, it is highly likely that the final costs for the building will require further capital investment from both Councils. The increased capital commitment required from FCC based on current estimates and with extensive contingencies would be £4,123,246. This is a potential increase of £1,095,464.</p> <p>The update in September, was a total projected expenditure of £12.521m.</p> <p>The revised Appendix F is now showing £12.857m, which is an increase of £0.336m. All income streams, income FCC match funding have remained the same.</p> <p>Denbighshire County Council formally approved their match funding in November 2023.</p>

	The ask from the Welsh Heritage Lottery Funding has gone from £7m to £7.336m to cover this increase in costs.
1.11	The need for the project has not diminished and this was reinforced by the recent accreditation process of NEWA. The maintenance of the required stringent BSI standards is achieved through The Archive Service Accreditation Scheme which is administered in Wales by Welsh Government. The service accreditation is due for renewal every four years, and recently a joint application from NEWA was prepared and submitted. NEWA was advised that it had retained its accreditation status on the 9 <sup>th</sup> November 2022, but through the process and in the subsequent report, were made very aware of the shortcomings associated with the buildings.
1.12	<p>Although the new archive centre represents much of the project cost, it is the activity plan and the potential outcomes for service users that represents the most exciting element. The new archive centre will enable NEWA to efficiently meet the storage and operational aspects of its in-house service, but most importantly it will allow it to maximise the skills and capacity to deliver a wider range of outreach activities, and to develop its digital service offer.</p> <p>NEWA has an ambition to widen their offer and reach out to new audiences, through the delivery of an activity programme that uses the rich collections as a source for storytelling and performance.</p> <p>Over the three year period of the initial delivery plan outlined in the bid, it is estimated that the service will reach 12,000 participants within the communities of both Councils, as well as offering a walk-in service at the new archive centre, so effectively offering a hub and spoke approach to service delivery, and a digital offer.</p>
1.13	<p>The Outline Activity Plan developed details for events and activities designed to engage new audiences across Flintshire and Denbighshire. Its delivery will be very much delivered in partnership with organisations involved with our priority audiences, including Theatr Clwyd, Libraries, charities, schools, colleges, HMP Berwyn and in specific locations, such as the former archive location at Ruthin Gaol and in Gladstone's Library in Hawarden, where people may feel that their service has been withdrawn. Only very limited engagement activities will be possible, unless NEWA can combine its resources within one facility.</p> <p>Welsh identity and heritage are vitally important for NEWA and its activity programme will be delivered bilingually and all literature and exhibitions will be bilingual.</p>
1.14	<p>KEY MILESTONES (should the bid be successful)</p> <p>June 2023- NLHF funding decision  Sept 2023- NLHF contract for the development phase (RIBA 1-3)  Sept 2023-Dec 2023- Procurement of Design and Build contractor</p>

	<p>Jan 2024-Mar 2024 – complete RIBA 2  Apr 2023- Jun 2024- complete RIBA stage 3  Jul 2024-Dec 2024 Planning  Sept 2024- NLHF development phase submission (assurance)  Sept 2024-Feb 2025- RIBA 4 Technical design  Jan 2025 – NLHF contract for the delivery phase (RIBA 5-7)  Jan 2025- Feb 2025 Approval of delivery phase contract  March 2025 Approval for construction contract  April 2025- May 2025 Mobilisation  May 2025 RIBA 5 construction starts on site  April 2026 NEWA Service contract in place  June 2026- RIBA 6 Handover of site  June 2026-Aug 2026 decant and recant service and collections  Sept 2026 NEWA operational in new archive centre  Sept 2027 Project evaluation and defects period concluded.</p>
1.15	<p>The revenue element of the business case for the joint service has yet to be fully developed but the business change proposed will need to be managed within the existing archive budget. Further to an in-principle agreement to the project and prior to any acceptance of any NLHF grant funding, the expectations of each Council and associated financial terms will need to be explored and contractually agreed to protect the interests of both parties. The financial and contractual terms would confirm that FCC will take on the lead responsibility for the commissioning, building and maintenance of any new building as it is located within the County Hall site. DCC would undertake the role of lead authority for the archive service and Flintshire staff would be employed by DCC and transferred under the appropriate employment conditions. The contract would include DCC's capital contribution to the project and the terms under which DCC will occupy the new building.</p>
1.16	<p>Should Informal Cabinet not support the ongoing development of the project then NEWA will have to remain as a joint service operating out of two buildings with the acceptance of the costs and risks remaining at The Old Rectory in Hawarden.</p>
1.17	<p>Should the project not attract the funding it requires from the NLHF Wales, the 'do nothing' option still attracts a cost, does not manage the risk and results in none of the proposed benefits being delivered. The Council would still need to maintain the Old Rectory building which would still leave an ongoing concern from Welsh Government regarding its suitability for a modern archive service and future accreditation status. An increasing revenue pressure for offsite commercial storage requirements would also remain.</p>

2.00	RESOURCE IMPLICATIONS
2.01	<p>The project is now estimated to cost £12,857m which is an increase of £0.366m. The ask from the Welsh Heritage Lottery Funding has gone from £7m to £7.336m to cover this increase in costs.</p> <p>The funding sources include £7.336m of NLHF funding, £300k WG Culture and Leisure department capital grant funding, (supported in principle by the department, but applied for prior to the year of use), with the balance of funding identified as a match funding requirement from both FCC and DCC based on a ratio of 60:40. The increased level of match funding identified, is due in part to increased inflation on construction materials. Other sources of funding for aspects of the project will be investigated in the development phase of the project, with a view to reducing the match funding requirement from both Councils.</p>
2.03	<p>The phased approach to the delivery of the project and the programme milestones, assist with the management of risk, by enabling informed decisions to be made at key points in the project.</p>
2.04	<p>In respect of the original project business case, the redesigned building in the same location will enable the delivery of the projected cashable benefits. In terms of the non- cashable benefits, the delivery of permanent exhibition space cannot now be achieved; instead Theatr Clwyd's exhibition space will be used as required. Although the building will now achieve net zero carbon standard in operation as opposed to Passivhaus, the repository will still be built to Passivhaus, and given that the building is significantly smaller, overall, it is not anticipated to have a greater carbon impact.</p>
2.05	<p>The provision of a joint archive facility would enable FCC to generate a capital receipt from the disposal of the Hawarden site.</p>
2.06	<p>During the life of the building, it is proposed that FCC to retain freehold for the land and the building and DCC will enter into a lease with FCC outlining clearly the terms of the shared occupation of the building (e.g. expectations around building management, maintenance and compliance). This lease would be for 25 years to begin with, pepper corn rate, and review periods and the opportunity to renew at the end of 25 years or expire. Cost sharing will be done based on population- currently 60/40 and reviewed in light of any new census data.</p>
2.07	<p>Considering the end of life of the building, it is proposed that DCC would not seek any return from sale or otherwise of the asset as the initial investment of capital by DCC, over the 25 years of operation, would have delivered a benefit to the organisation over and above any sort of return from sale.</p>
2.08	<p>Whilst FCC will have responsibility for the building, it is proposed that DCC will undertake the lead authority role in respect of the NEWA joint service contract, with both authorities equally represented on a Joint Service Board.</p>



2.09	In terms of the operational budget for the NEWA service, the restructure and business change proposed will be managed within the existing service budgets. The smaller building will be less costly to operate, although the rateable value is anticipated to be higher. This is offset against the ongoing cost to the service of offsite storage which will be negated by a new building. An outline business plan has been developed for the service, and will be updated during the development phase, as more work is done, and costs are confirmed.
2.10	Prior to any acceptance of any NLHF grant funding offered, the heads of terms between Flintshire County Council and Denbighshire County Council need to be agreed. This manages any risk to Flintshire County Council in terms of Denbighshire County Council's commitment to its proportion of the match funding, and the project delivery arrangements. Equally it will provide Denbighshire County Council with security of tenure within the new archive facility and provide the terms of the arrangements between both Councils going forward, in respect of the building, the staff, the operational budgets and the management arrangements.
2.11	<p>Impact on other services</p> <ul style="list-style-type: none"> <li>i. Legal – support required relating to contractual arrangements related to any grant funding and the collaborative arrangements between the Councils.</li> <li>ii. Financial support- relating to any grant funding administration and the establishment and support of the collaborative service</li> <li>iii. HR- support required in creation of a single shared service.</li> <li>iv. ICT-support and input related to the future ICT solution and application</li> <li>v. Archive- restructure and introduction of new way of working. Engagement with the design process, decant and recant of archives, and business as usual working across 2 counties,</li> <li>vi. Building Design and Cost Consultancy- input into procurement of contractor and specification of the building</li> <li>vii. Procurement-advice and guidance</li> <li>viii. Building Maintenance- advice and support related to the delivery of the grant outputs, and the collaborative arrangements related to the building</li> <li>ix. Strategic Assets – the requirement to operate, manage the Old Rectory, Hawarden, in a different way once Archive's vacate or/and arrange for is disposal.</li> </ul>
2.12	<p>Impact on Biodiversity and the environment include:</p> <ul style="list-style-type: none"> <li>i. The design will incorporate garden areas which will be used to "rewild" the landscape creating biodiversity rich spaces. The plans for the gardens will also complement the drainage and attenuation strategy for the site, creating channels that hold water and thus provide a more diverse plant and animal habitat.</li> <li>ii. Opportunities to incorporate features for biodiversity into the new building will also be maximised. For example, in built bat and bird</li> </ul>

	<p>boxes that will complement the landscaping and provide homes for species already on site.</p> <p>iii. It is estimated this project will generate a significant carbon saving of that will contribute towards FCC's commitment to reducing its carbon emissions, and the move to becoming a carbon neutral Council in line with Welsh Government's ambition for a carbon neutral public sector by 2030.</p> <p>iv. This project supports the Council's "Green Council" priority by reducing carbon emissions, via its Net zero Carbon/Passivhaus design, and increase the amount of energy generated by renewables, via installation of solar PV on the roof and consideration of inclusion of a small ground source heat pump to provide space heating and cooling requirements.</p>
2.13	<p>Anti-Poverty impact include:</p> <p>i. Consideration will be given to providing supportive rates on any fees and charges activity undertaken by the Joint Archive Service (e.g. search room bookings)</p>
2.14	<p>Equalities impact include:</p> <p>ii. The new building will be fully DDA compliant and accessible for all users which the current sites are not.</p> <p>iii. The new building will be purposely designed as an archive facility and therefore designed with health and safety of staff and customers in mind.</p> <p>iv. The Joint Archive Service delivery model is that of a hub and spoke. The hub being the new building in Mold and the spokes being permanent and temporary outreach activity across the two counties. Permanent archive access points within libraries for example for digitalised records and temporary initiatives out in communities and with partners on specific topics.</p>

<b>3.00 CONSULTATIONS REQUIRED / CARRIED OUT</b>	
3.01	<p>Formal reports have been presented to the following groups:</p> <p>i. Informal Cabinet (November 2018, October 2019, September 2021)</p> <p>ii. Capital and Assets Programme Board (July 2019)</p> <p>iii. Special COT (September 2019)</p> <p>iv. COT Business (October 2019, January 2022 &amp; November 2022)</p> <p>v. Education and Youth Operational Scrutiny Committee (November 2019)</p> <p>vi. Cabinet (November 2019)</p>
3.02	<p>Specific engagement meetings have been had with the following internal stakeholders within Flintshire:</p> <ul style="list-style-type: none"> <li>• Political: Lead Members and ward Members</li> <li>• Operational: CEO, Chief Officers Team, Flintshire Record Office (archive service), Legal Services, Financial Services, Biodiversity Officer,</li> </ul>

	Conservation Officer, Trees Officer, Building Design & Cost consultancy Team Leader, Carbon Officer, Health and Safety Officer, and Strategic Assets.
3.03	Externally the following have been engaged with: <ul style="list-style-type: none"> <li>• Denbighshire County Council</li> <li>• Wrexham County Borough Council</li> <li>• Theatr Clwyd</li> <li>• The National Archive (TNA)</li> <li>• Wales Assembly Government – Culture and Leisure Department</li> <li>• The National Lottery Heritage Fund (NLHF)</li> <li>• Glyndwr University</li> <li>• HMP Berwyn</li> <li>• Various charities and other providers</li> </ul>
3.04	Consultation and engagement with our key funder NLHF, archive users and traditionally non-users and activity plan delivery partners will be ongoing. So far, the public have been engaged as follows: <ul style="list-style-type: none"> <li>• Stand and questionnaire at the Flint and Denbigh Show (August 2019)</li> <li>• Public Briefing and online questionnaire launched via social media (September 2019)</li> <li>• Consultation with service users about proposed changes. Majority of responses received were in favour of proposals.</li> </ul>
3.05	Consultation with elected members, especially Cabinet and Hawarden ward members, which will be ongoing.
3.06	Consultation with local stakeholders and key partners will also be undertaken e.g. local history groups, Gladstone Library, Aura Libraries and Leisure etc.

<b>4.00</b>	<b>IMPACT ASSESSMENT AND RISK MANAGEMENT</b>						
4.01	The Project Risk Register is included at Appendix E						
4.02	<p>Under the five delivery principles of the Well-being of Future Generations Act this project scored 3 out of 4 stars (actual score 28/36). Implications of the score include: -</p> <p><b>Ways of Working (Sustainable Development) Principles Impact</b></p> <table border="1"> <thead> <tr> <th>Ways of Working Principle</th> <th>Impact</th> </tr> </thead> <tbody> <tr> <td>Long-term</td> <td rowspan="3">The business case does evidence a long term view, particularly on the impact and outcomes it aims to achieve from the delivery of its Activity Plan.</td> </tr> <tr> <td>Prevention</td> </tr> <tr> <td>Integration</td> </tr> </tbody> </table>	Ways of Working Principle	Impact	Long-term	The business case does evidence a long term view, particularly on the impact and outcomes it aims to achieve from the delivery of its Activity Plan.	Prevention	Integration
Ways of Working Principle	Impact						
Long-term	The business case does evidence a long term view, particularly on the impact and outcomes it aims to achieve from the delivery of its Activity Plan.						
Prevention							
Integration							

	<b>Collaboration</b>	The business case can be improved by considering in greater detail the legacy for the vacated spaces in Ruthin and Hawarden, and plans for transport and travel to the new site in Mold (particularly from the bus station in central Mold up onto the hill) including active travel options
	<b>Involvement</b>	
4.03	Against the seven well-being goals of the Act, the potential impact of the report is evaluated as follows: -	
	<b>Well-being Principle</b>	<b>Impact</b>
	Prosperous Wales	Positive
	Resilient Wales	Neutral
	Healthier Wales	Positive
	More Equal Wales	Positive
	Cohesive Wales	Positive
	Vibrant Wales	Positive
	Globally Responsible Wales	Neutral

<b>5.00</b>	<b>APPENDICES</b>
5.01	<ul style="list-style-type: none"> <li>• Appendix A- Memorandum of Understanding</li> <li>• Appendix B- Service Design Summary</li> <li>• Appendix C- Relationship Basis</li> <li>• Appendix D- Joint Archive Project Structure</li> <li>• Appendix E- Project Risk Register</li> <li>• Appendix F- Revised Project Cost Summary</li> </ul>

<b>6.00</b>	<b>LIST OF ACCESSIBLE BACKGROUND DOCUMENTS</b>
6.01	<p><b>Contact Officer:</b> Sian Price, Project Manager / Craig Berry, Joint Archive Manager  <b>Telephone:</b> 07917 06731 / 01824 708023  <b>Email:</b> <a href="mailto:sian.lloydprice@denbighshire.gov.uk">sian.lloydprice@denbighshire.gov.uk</a>  <a href="mailto:craig.berry@denbighshire.gov.uk">craig.berry@denbighshire.gov.uk</a></p>

7.00	<b>GLOSSARY OF TERMS</b>
7.01	<p><b>Passivhaus</b>  Passive house refers to buildings created to rigorous energy efficient design standards so that they maintain an almost constant temperature. Passivhaus buildings are so well constructed, insulated and ventilated that they retain heat from the sun and the activities of their occupants, requiring very little additional heating or cooling.</p> <p><b>Net Zero Carbon</b>  Net zero carbon refers to achieving net zero carbon emissions by balancing a measured amount of carbon released with an equivalent amount sequestered or offset, or buying enough carbon credits to make up the difference.</p> <p><b>Service delivery model</b>  There will be 1 archive service covering Denbighshire and Flintshire together. At the minute there are 2 Archive Services- 1 covering just Denbighshire and 1 covering just Flintshire.</p> <p><b>Hub and spoke service delivery model</b>  This is where the archive service is taken out to where the public are (e.g. in communities) instead of the public coming to where the archive service is (e.g. in Mold, Hawarden, Ruthin).</p> <p><b>Outreach</b>  This is where the archive service is taken out to where the public are (e.g. in communities) instead of the public coming to where the archive service is (e.g. in Mold, Hawarden, Ruthin).</p> <p><b>RIBA</b>  Relates to the Royal Institute of British Architects. When RIBA appears with a number after it, e.g. RIBA 3, this relates to a stage of the Plan of Work which is used by Architects and Building Professionals to organise the tasks, information gathering and consultation that they need to undertake, when delivering a construction project.</p>

Mae'r dudalen hon yn wag yn bwrpasol

# Memorandum of understanding for joint working by public bodies

## Flintshire and Denbighshire Joint Archive

This agreement is dated 13 November 2023

### PARTIES

- (1) DENBIGHSHIRE COUNTY COUNCIL of Wynnstay Road, Ruthin Denbighshire (DCC)
- (2) FLINTSHIRE COUNTY COUNCIL of Raikes Lane, Mold, Flintshire (FCC)

### 1. BACKGROUND

1.1 DCC and FCC have been working together on the Project detailed in [Annex A \(Project\)](#) since 2019.

1.2 The Parties wish to record the basis on which they will continue to collaborate with each other on the Project. This Memorandum of Understanding (**MoU**) sets out:

- (a) the key objectives of the Project;
- (b) the principles of collaboration;
- (c) the governance structures the Parties will put in place; and
- (d) the respective roles and responsibilities the Parties will have during the Project.

### 2. KEY OBJECTIVES FOR THE PROJECT

2.1 The Parties shall undertake the Project to achieve the key objectives set out in [Annex A](#) to this MoU (**Key Objectives**).

2.2 The Parties acknowledge that the current position with regard to the Project and the contributions already made (financial and otherwise) are as detailed in the [Annex A](#) to this MoU.

### 3. PRINCIPLES OF COLLABORATION

3.1 The Parties agree to adopt the following principles when carrying out the Project (**Principles**):

- (a) collaborate and co-operate. Establish and adhere to the governance structure set out in this MoU to ensure that activities are delivered and actions taken as required;
- (b) be accountable. Take on, manage and account to each other for performance of the respective roles and responsibilities set out in this MoU;
- (c) be open. Communicate openly about major concerns, issues or opportunities relating to the Project;
- (d) learn, develop and seek to achieve full potential. Share information, experience, materials and skills to learn from each

## Appendix A

other and develop effective working practices, work collaboratively to identify solutions, eliminate duplication of effort, mitigate risk and reduce cost;

- (e) adopt a positive outlook. Behave in a positive, proactive manner;
- (f) adhere to statutory requirements and best practice. Comply with applicable laws and standards including EU procurement rules, data protection and freedom of information legislation;
- (g) act in a timely manner. Recognise the time-critical nature of the Project and respond accordingly to requests for support;
- (h) manage stakeholders effectively;
- (i) deploy appropriate resources. Ensure sufficient and appropriately qualified resources are available and authorised to fulfil the responsibilities set out in this MoU. [In particular the Parties agree to make the contributions detailed in [Annex C](#) to this MoU]; and
- (j) act in good faith to support achievement of the Key Objectives and compliance with these Principles.

### 4. PROJECT GOVERNANCE

#### 4.1 Overview

The governance structure defined below provides a structure for the development and delivery the Project.

#### 4.2 Guiding principles

The following guiding principles are agreed by both Parties on which the Project Board will operate:

- (a) members of the Board to provide strategic oversight and direction;
- (b) Board be based on clearly defined roles and responsibilities at organisation, group and, where necessary, individual level;
- (c) that decision making required for the Project is aligned both in terms of timing and level in both organisations (e.g. that papers are considered at Cabinet at the same meeting month in both Flintshire and Denbighshire County Councils)
- (d) that Board membership be aligned with Project scope [and each Project phase] (and may therefore require changes over time);
- (e) that Board utilise existing organisational, group and user interfaces in carrying out its work;
- (f) that Board provide coherent, timely and efficient decision-making; and
- (g) that Board correspond with the key features of the Project governance arrangements set out in this MoU.

#### 4.3 Project Executives

- (a) **Project Executives** provide overall strategic oversight and direction to the Project Board. Project Executives are:

**Denbighshire County Council:** Chief Executive – Graham Boase

**Flintshire County Council:** Chief Executive – Neal Cockerton



## Appendix A

(b) Project Executives shall receive updates from the Project Sponsors - Head of Housing and Communities Service, Denbighshire County Council, and Chief Officer Education & Youth, Flintshire County Council, at no later than quarterly intervals. The Project Board may provide decision recommendations to the Project Executives for decisions deemed large enough. However, this is by exception and it is expected most decision making is taken at Project Board level chaired by Project Sponsors.

(c) In the circumstance of personnel changes the aforementioned will be replaced by their successor or, if the post is no longer there, a manager of equivalent standing or above.

### 4.4 Project Board

(a) The Project Board will provide the strategic management for Project, chaired by Project Sponsors. The Project Manager works to the Project Board and will provide assurance to the Project Board that the Key Objectives are being met and that the Project is performing within the boundaries set by the Project Board.

(b) The Project Board consists of representatives from each of the Parties. The Project Board shall have responsibility for the creation and execution of the Project plan and deliverables, and therefore it can draw technical, commercial, legal and communications resources as appropriate into the Project Board. The core Project Board members are:

Liz Grieve	<b>Project Executive</b> and Head of Housing and Customer Services, Denbighshire County Council
Craig Berry	NEWA Joint Archive Service Manager, employed by Denbighshire County Council
Cllr Emrys Wynne	Cabinet Member for Welsh Language, Culture and Heritage, Denbighshire County Council
Cllr Christopher Bithell	Cabinet Member for Planning and Public Protection, Flintshire County Council
Claire Homard	<b>Project Executive</b> and Chief Officer Education & Youth, Flintshire County Council
Sian Lloyd Price	Project Manager, Denbighshire County Council

The Project Board shall meet monthly.

(c) In the circumstance of personnel changes the aforementioned will be replaced by their successor or, if the post is no longer there, a manager of equivalent standing or above.

### 4.5 Reporting

Project reporting shall be undertaken at two levels:

(a) **Project Board:** Minutes and actions will be recorded for each Project Board meeting. Any additional reporting requirement shall be at the discretion of the Project Board.

(b) **Organisational:** The Project Board members shall be responsible for drafting reports into their respective sponsoring organisation as required for review by the Project Board before being issued.

## 5. ROLES AND RESPONSIBILITIES

5.1 The Parties shall undertake the following roles and responsibilities to deliver the Project:

Activity	Denbighshire County Council	Flintshire County Council
Project Management	Lead	Assure
Phase I- Single Shared Service	Lead	Assure
Phase II- New Building	Assure	Lead
Phase III – Activity Plan	Assure	Lead

## Appendix A

National Lottery Heritage Fund Major Grant Application	Assure	Lead
Accountable Body (financial manager for the Project and main contact with bodies as the project is developed)	Lead	Assure
Accountable Body (financial manager for the Project related to any major grants that are secured)	Assure	Lead
ICT	Lead	Assure

### 5.2 For the purpose of the table above:

**(a) Lead:** the Party that has principal responsibility for undertaking the particular task, and that will be authorised to determine how to undertake the task. The Lead must act in compliance with the Objectives and Principles at all times, referring back to Project Board, and consult with the other Party in advance if they are identified as having a role to Assure the relevant activity;

**(b) Assure:** the Party that will defer to the Lead on a particular task, but will have the opportunity to review and provide input to the Lead before the Lead takes a final decision on any activity. All assurance must be provided in a timely manner. Any derogations raised must be limited to raising issues that relate to specific needs that have not been adequately addressed by the Lead and/or concerns regarding compliance with the Key Objectives and Principles.

### 5.3 Within 3 months of the date of this MoU the Party with the lead role for any aspect of the Project shall continue to develop a delivery plan for that part of the Project which shall identify the following:

- (a)** the key milestones for the delivery the Key Objectives;
- (b)** what employees (other than employees identified in this MoU) will be required to work on the Project itself;
- (c)** whether any staff will need to be seconded from one Party to the other;
- (d)** what staff will require access to the premises of the other Party;
- (e)** What cost allocation model, if any, will be deployed to fund the task needing to be completed.

Each delivery plan must be approved by the Project Board prior to being implemented.

## 6. ESCALATION

**6.1** If either Party has any issues, concerns or complaints about the Project, or any matter in this MoU, that Party shall notify the other Party and the Parties shall then seek to resolve the issue by a process of consultation. If the issue cannot be resolved within a reasonable period of time [10 working days], the matter shall be escalated to the Project Board, which shall decide on the appropriate course of action to take.

**6.2** If either Party receives any formal inquiry, complaint, claim or threat of action from a third Party (including, but not limited to, claims made by a supplier or requests for information made under the Freedom of Information Act 2000) in relation to the Project, the matter shall be promptly referred to the Project Board (or its nominated representatives). No action shall be taken in response to any such inquiry, complaint, claim or action, to the extent that such response would adversely affect the Project, without the prior approval of the Project Board (or its nominated representatives). However, each Party must comply with its legal obligations and time frames under any specific legislation relevant. No Party should put itself in a detrimental position because the Board hasn't managed to meet or make a decision for example.

## **7. INTELLECTUAL PROPERTY**

**7.1** The Parties intend that [notwithstanding any secondment] any intellectual property rights created in the course of the Project shall vest in the Party whose employee created them (or in the case of any intellectual property rights created jointly by employees of both Parties in the Party that is lead Party noted in [Clause 5](#) above for the part of the Project that the intellectual property right relates to).

**7.2** Where any intellectual property right vests in either Party in accordance with the intention set out in [Clause 7.1](#) above, that Party shall grant an irrevocable licence to the other Party to use that intellectual property for the purposes of the Project.

## **9. CHARGES AND LIABILITIES**

**9.1** Except as otherwise provided, the Parties shall each bear their own costs and expenses incurred in complying with their obligations under this MoU.

**9.2** The Parties agree to share the costs and expenses arising in respect of the Project between them in accordance with the Contributions Schedule set out in [Annex C](#) to this MoU.

**9.3** Both Parties shall remain liable for any losses or liabilities incurred due to their own or their employee's actions and neither Party intends that the other Party shall be liable for any loss it suffers as a result of this MoU.

## **10. STATUS**

**10.1** This MoU is not legally binding, and no legal obligations or legal rights shall arise between the Parties from this MoU. The Parties enter into the MoU intending to honour all their obligations.

**10.2** Nothing in this MoU is intended to, or shall be deemed to constitute either Party as the agent of the other Party, nor authorise either of the Parties to make or enter into any commitments for or on behalf of the other Party.

## **11. GOVERNING LAW AND JURISDICTION**

This MoU shall be governed by and construed in accordance with the laws of England and Wales and, without affecting the escalation procedure set out in [Clause 6](#), each Party agrees to submit to the exclusive jurisdiction of the courts of Wales.

Appendix A

**Signed for and on behalf of DCC**

Signature:

Name: Liz Grieve

Position: Head of Housing & Communities Service

Date: 13/11/23

**Signed for and on behalf of FCC**

Signature:



Name: Neal Cockerton (on behalf of Claire Homard)

Position: Chief Executive

Date: 13/11/23

## Appendix A

### CONTACT POINTS

#### **Authority One**

#### **Denbighshire County Council**

Name:

Liz Grieve

Office address:

Denbighshire County Council

County Hall

Wynnstay Road

Ruthin

Denbighshire

LL15 1YN

Tel No:

01824 708019

E-mail Address:

Liz.grieve@denbighshire.gov.uk

#### **Authority Two**

#### **Flintshire County Council**

Name:

Claire Homard

Office Address:

Flintshire County Council

County Hall

Raikes Lane

Mold

Flintshire

CH7 6ND

Tel No:

01352 704190

## Appendix A

E-mail Address:

claire.homard@flinshire.gov.uk

### **ANNEX A - THE PROJECT**

#### **Project overview**

To provide a sustainable, efficient and improved archive service for Denbighshire & Flintshire via:

- PHASE 1 - the creation of a single shared service.
- PHASE 2 - the construction of a new purpose built building, (ideally to Passiv Haus standard), adjacent to Theatr Clwyd, Mold, to house both the physical Archives and the new Service operations.
- PHASE 3- an associated 3 years activity plan which will deliver a revolutionary and radical archive offer to the public.

Phases 2 and 3 are dependent on National Lottery Heritage Fund funding. If NLHF cannot be secured, then PHASE 1- the creation of a single shared service would still be progressed, and other options progressed to deliver a permanent solution to the accommodation issues.

#### **The Key Objectives**

##### Phase 1 - Single Shared Service

The Project will deliver a single shared service covering Flintshire County Council and Denbighshire County Council to start with, with the potential to extend to more partners in the future.

The service has been created via structured informal collaboration initially with associated agreements and a cost allocation model put in place. This model is reviewed at least annually with the potential to move to a formal delegation of service from one organisation to the other at a later date if Parties deem it appropriate.

A new joint archive manager role was to be created to manage this single shared service and seconded to Denbighshire County Council as the employing authority for that role for a 12-month period to begin with, with a look to extend if the funding application to NLHF is successful. The wider staff groups will remain on their current contracts with their existing employer. The Project Board will oversee the business change that will be required as the Service works towards a new operating model, which may include some earlier appointments to key roles as opportunities present themselves within the existing staff structure.

The Single shared service went live in 1<sup>st</sup> April 2020, and the Joint Archive Service Manager secondment commenced in January 2020.

The Vision for the Joint Service is: 'We will use the rich documentary heritage of NE Wales to inspire, educate and entertain people'.

The Mission for the Joint Service is: Our mission is to preserve our collections for future generations and to engage people with the documentary heritage of NE Wales.

It will deliver upon the following objectives:

- deliver the long-term creation of a resilient, relevant combined service
- delivering into the heart of its communities to support skills
- play its part in The Wellbeing of Future Generations Act
- securing historic collections, diversifying audiences, volunteers and depositors.

## Appendix A

### Phase 2- New Building

The Project will deliver an accommodation solution for the new, single shared service.

The first choice option was a purpose-built, 'state of the art', Passivhaus archive building adjacent to Theatr Clwyd, Mold using NLHF Heritage Horizon grant (unlimited). The second choice option is a purpose-built archive building adjacent to Theatr Clwyd, Mold using NLHF Wales standard grant (up to maximum £5m). The third choice option is the conversion of an existing or procured asset into environmentally controlled storage, vacation of existing Archive building, no external grant funding but should not cost more than the 2 authorities would need to put in as match funding to a NLHF funded project. The fourth choice option is the retention of existing archive buildings (Ruthin and Hawarden) and the utilisation of commercial storage to house expanding collections.

### Phase 3- Activity Plan

Alongside the new building, if option 1 or 2 is progressed using NLHF funding, the Project will deliver a 3 years activity plan which will deliver the preparation of resources, service offering and partnerships in the lead up to the new building opening and in the first 18 months of the new building operating.

#### **The existing position and contributions already made**

As at 13<sup>th</sup> November 2023 the Project position is as follows:

- Project Board set up and meeting monthly
- Project Brief presented to Informal Cabinet at both organisations in November 2018
- Business case shared with Chief Officer Group, (FCC) and Strategic Investment Group, (DCC) in September 2019 and politically in November 2019.
- Welsh Government Museum, Archive and Libraries Division (MALD) grant funding secured with Denbighshire County Council administering the grant
- Informal reports to both Cabinets in September 2021, regarding the next steps further to the unsuccessful HLF Heritage Horizon Award funding application.
- National Lottery Heritage Funding Expression of Interest was successful and Round 1 application is due to be submitted in November 2021.
- Cabinets of both authorities are aware of the project application and the NLHF Local Authority match funding requirement; in respect of FCC there is a signed decision.
- NLHF application submitted in November 2021 was withdrawn in February 2022
- Update shared with Chief Officer Group (FCC) and Informal Cabinet(FCC) in January 2023, endorsed support for new NLHF application in 2023
- Business Case shared with Capital Scrutiny Group (DCC) in September 2023, and Cabinet in 2023, where the NLHF Local Authority match funding requirement was approved.
- Project Manager was appointed by Denbighshire County Council to work 1 day per week on the Project up until 30<sup>th</sup> September 2019 and since 2 days per week on the Project up until 31<sup>st</sup> March 2023.
- Joint Archive Service Manager commenced 1<sup>st</sup> January 2020, and post was made permanent in December 2022.

Contributions (including commitments) already made by both Parties as at 31<sup>st</sup> March 2023:

	<b>DENBIGHSHIRE COUNTY COUNCIL</b>	<b>FLINTSHIRE COUNTY COUNCIL</b>
Welsh Government MALD grant funding 2018/19- match	£200	£200
Project Management 1 day a week for 6 months (1 <sup>st</sup> April- 30 <sup>th</sup> Sept 2019)	£5149.50	£5149.50
Revenue feasibility monies	£4987.50	£4987.50
Joint Archive Service Manager for 12 months (1 <sup>st</sup> January 2020 - 21 <sup>st</sup> March 2020)	£ 3490.01	£5235.01

## Appendix A

Project Management 2 days a week for 6 months (1 <sup>st</sup> Oct 2019-31 <sup>st</sup> Mar 2020)	£4885	£4885
Project Management 2 days a week for 12 months (1 <sup>st</sup> April 2020-31 <sup>st</sup> Mar 2021+ additional resource approved by Project Board 15/01/21)	£15,949.50	£15,949.50
Joint Archive Service Manager for 12 months (full time from Jan 2021)	£12711.16	£19066.74
Revenue feasibility monies	£1500	£1500
Project Management 2 days a week for 12 months (1 <sup>st</sup> April 2021-31 <sup>st</sup> March 2022)	£13000	£13000
Joint Archive Service Manager for 12 months (1 <sup>st</sup> April 2021-31 <sup>st</sup> March 2022)	£27730	£41595
Revenue feasibility monies	£4720	£4720
Joint Archive Service Manager for 12 months (1 <sup>st</sup> April 2022 -31 <sup>st</sup> March 2023)	£29400	£44100
Project Management 2 days a week for 12 months (1 <sup>st</sup> April 2022-31 <sup>st</sup> March 2023)	£11527	£11527
Joint Archive Service Manager for 12 months (1 <sup>st</sup> April 2023 -31 <sup>st</sup> March 2024)	£30430	£45645
Project Management 2 days a week for 12 months (1 <sup>st</sup> April 2023-31 <sup>st</sup> March 2024)	£9702	£9702

## ANNEX B - INFORMATION SHARING PROTOCOL

Our citizens and communities expect that we work together with our partners to deliver effective and joined-up services. Sharing of personal information for service delivery purposes is one of the key enabling mechanisms for improving collaboration, integration and ensuring effective decision-making. There are seven golden rules for information sharing:

- Ensure Information you share is necessary, proportionate, relevant, adequate, accurate, timely and secure. It should be shared only with those individuals who need to have it.
- Consider safety and well-being - base decisions on the safety and well-being of the individual and others who may be affected by their actions.
- Gather consent where appropriate - Share with informed consent and, where possible, respect the wishes of those who do not consent to share confidential information. You may still share information without consent if, in your judgement, there is good reason to do so, such as where safety may be at risk.
- Keep a record of your decision and the reasons for it – whether it is to share information or not. If you decide to share, then record what you have shared, with whom and for what purpose.
- Be open and honest with the individual from the outset about why, what, how and with whom information will, or could be shared, and seek their agreement, unless it is unsafe or inappropriate to do so.
- Data protection is a framework to work to and not a barrier - Remember that Data Protection legislation and human rights law are not barriers to justified information sharing, but provide a framework to ensure that personal information about



## Appendix A

living individuals is shared appropriately.

### **ANNEX C - CONTRIBUTIONS / RESOURCE MANAGEMENT**

#### **Accountable Body**

Denbighshire County Council is nominated as the Accountable Body for the collaboration and will act on the collaborations decisions, including:

- Securing and signing contracts or service level agreements and funds.
- Administering and taking responsibility for the funding (e.g. ensuring structured financing procedures are in place).
- Providing resources (e.g. staff, facilities) to carry out the financial obligations of the collaboration.
- Ensuring that the grant allocated is spent according to the agreed plan.
- Establishing and maintaining effective systems for auditing and monitoring expenditure.

Flintshire County Council is nominated as the Accountable Body for any major grants and will

- Secure and sign contracts with funding bodies
- Administering and taking responsibility for the funding (e.g. ensuring structured financing procedures are in place).
- Providing resources (e.g. staff, facilities) to carry out the financial obligations of any major grants
- Ensuring that the grant allocated is spent according to the agreed plan.
- Establishing and maintaining effective systems for auditing and monitoring expenditure.

#### **Grant Funding**

The collaboration has secured the following external grant funding as at 05.08.19 to carry out its work:

<b>DATE</b>	<b>SOURCE</b>	<b>AMOUNT</b>
2018/19	Welsh Government MALD	£3,600
2019/20	Welsh Government MALD	£10,000

The collaboration agrees to spend funds in accordance with the grants' terms and conditions and agrees to be responsible for understanding grant funding criteria and ensure that their respective organisations can work within the confines of the criteria.

#### **Apportionment of losses**

The apportionment of any losses to the date of National Lottery Heritage Fund grant decision in December 2020 will be apportioned equally between organisations, i.e. 50/50. This will be limited to the cost of pursuing the funding application.

## Appendix A

### Cross charging

Any cross charging will be done on the following terms:

	Denbighshire's Contribution	Flintshire's Contribution
Development costs for National Lottery Heritage Fund bid (to date of decision – December 2020)	50%	50%
Cost of client side Project management	50%	50%
Cost of match funding the NLHF bid (assuming bid approved)	*40%	*60%
Costs of operating the single shared service	*40%	*60%
Costs of operating the new building	*40%	*60%
Costs of Joint Archive Service Manager secondment	*40%	*60%

\* Based on the population sizes of each Council administrative area as at 2011 and by reference to the latest Census.

It is one of the overriding principles that the Parties should not end up with a service which costs more than it currently does to provide. So for the cost of operating the single shared service, the organisation currently paying the least will represent the common denominator and the corresponding percentage contribution calculated from that. For example, DCC has the lowest current operating budget of £154,488 (as at 2019/20) and therefore represents 40%. FCC contribution calculated as follows:  $154,488/40*60 = £231,732$ . If this is less than what FCC is currently paying, that Party may choose to contribute more to the single shared service but they would not be obliged to. Equally FCC may choose to reduce its contribution to the £231,732 level on a gradual basis or/and only once the joint service has moved into the new building.

### Partners Contribution to the Collaboration

Contributions (including commitments) already made by both Parties as at 31<sup>ST</sup> March 2023:

## Appendix A

	DENBIGHSHIRE COUNTY COUNCIL	FLINTSHIRE COUNTY COUNCIL
Welsh Government MALD grant funding 2018/19- match	£200	£200
Project Management 1 day a week for 6 months (1 <sup>st</sup> April- 30 <sup>th</sup> Sept 2019)	£5149.50	£5149.50
Revenue feasibility monies	£4987.50	£4987.50
Joint Archive Service Manager for 12 months (1 <sup>st</sup> January 2020 - 21 <sup>st</sup> March 2020)	£ 3490.01	£5235.01
Project Management 2 days a week for 6 months (1 <sup>st</sup> Oct 2019- 31 <sup>st</sup> Mar 2020)	£4885	£4885
Project Management 2 days a week for 12 months (1 <sup>st</sup> April 2020- 31 <sup>st</sup> Mar 2021+ additional resource approved by Project Board 15/01/21)	£15,949.50	£15,949.50
Joint Archive Service Manager for 12 months (full time from Jan 2021)	£12711.16	£19066.74
Revenue feasibility monies	£1500	£1500
Project Management 2 days a week for 12 months (1 <sup>st</sup> April 2021- 31 <sup>st</sup> March 2022)	£13000	£13000
Joint Archive Service Manager for 12 months (1 <sup>st</sup> April 2022-31 <sup>st</sup> March 2023).	£27730	£41595
Revenue feasibility monies	£4720	£4720
Project Management 2 days per week for 12 months (1 <sup>st</sup> April 2022-31 <sup>st</sup> March 2023),	£11527	£11527
Joint Archive Service Manager for 12 months (1 <sup>st</sup> April 2022- 31 <sup>st</sup> March 2023).	£29400	£44100
Joint Archive Service Manager for 12 months (1 <sup>st</sup> April 2023 -31 <sup>st</sup> March 2024)	£30430	£45645
Project Management 2 days a week for 12 months (1 <sup>st</sup> April 2023- 31 <sup>st</sup> March 2024)	£9702	£9702

Calls for additional contributions will be made as and when required.

The Service collaborations budget will be managed by the Joint Service Manager.

The Project Budget will be managed by the Client Project Manager

Developments will be funded as per details in cross charging section above.

Under and overspends will be dealt with according to the cross charging section above.

### Joint Archive Service Manager

A new post entitled Joint Archive Service Manager is to be created. This is a 0.5 FTE role and was recruited in the first instance for 15 months commencing 6<sup>th</sup> January 2020 to 31<sup>st</sup> March 2021. This secondment is to be continued until further notice.

The appointing organisation is Denbighshire County Council. Liz Grieve will be the line manager for the role and the role will take strategic direction from The Joint Archive Project Board who will also set the roles forward work programme.

## Appendix A

The post is funding jointly with Flintshire County Council paying 60% of the salary + on costs and Denbighshire County Council paying 40% of the salary + on costs.

Denbighshire will manage all costs related to the role and invoice Flintshire County Council annually based on the 60/40 cost allocation model.

### **Sustainability**

Denbighshire County Council shall be liable for any redundancy costs associated with the downsizing or termination of the post of Project Manager assigned to this Project.

The Parties to the Project shall each bear their own costs in association with any redundancies which may arise as a result of the creation of a single shared service.

### **Audit arrangements**

Any requirement for internal audit reviews will be led by the Accountable Body's internal audit service following agreement of the partner organisations' internal audit services.

### **Contracting**

The collaboration will adhere to Denbighshire County Council's Contract Procedure Rules [July 2016], including contracts procedures and requirements for tendering.

## The North East Wales Archive Service (NEWAS) Service Design Summary January 2019

### Introduction

This is a synthesis of the work undertaken by Denbighshire and Flintshire Councils to create a conceptual design for a joint archive service in 2018 to provide the basis for developing a strategic plan and funding strategy for the new service. This summary includes:

- The Vision p1
- The conceptual structure p1
- Desired services p2
- Desired impacts p3
- Potential 'markets' for services p4
- Channels for service delivery p5
- Attributes of the archive building p5
- Digital functionality p6
- Vision ideas for an integrated service p7
- Stakeholder analysis p8

### 1. The Vision

Harnessing the power of our shared documentary heritage to promote education, well-being and identity for the people and communities of North-East Wales.

### 2. Conceptual structure of the joint service

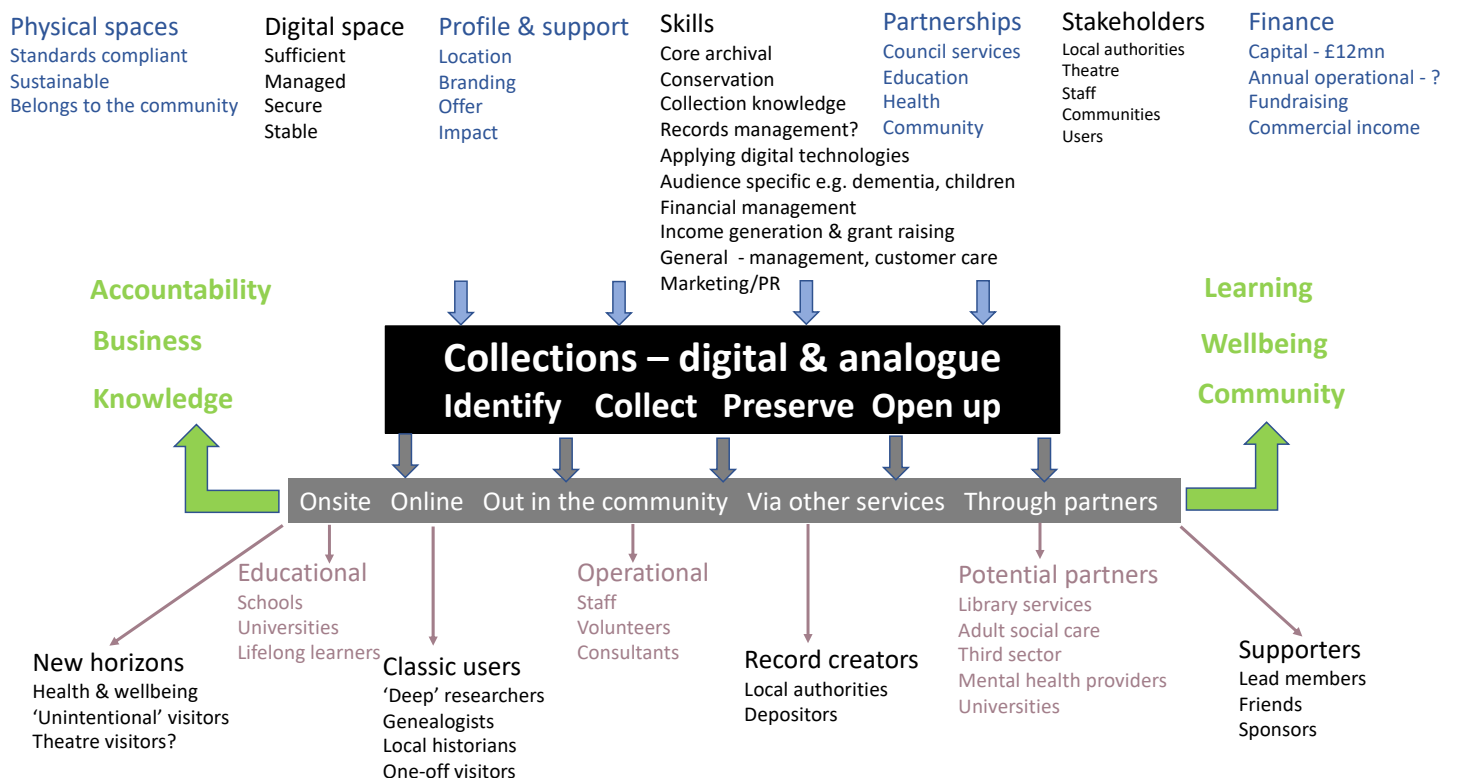

### 3. Desired Services

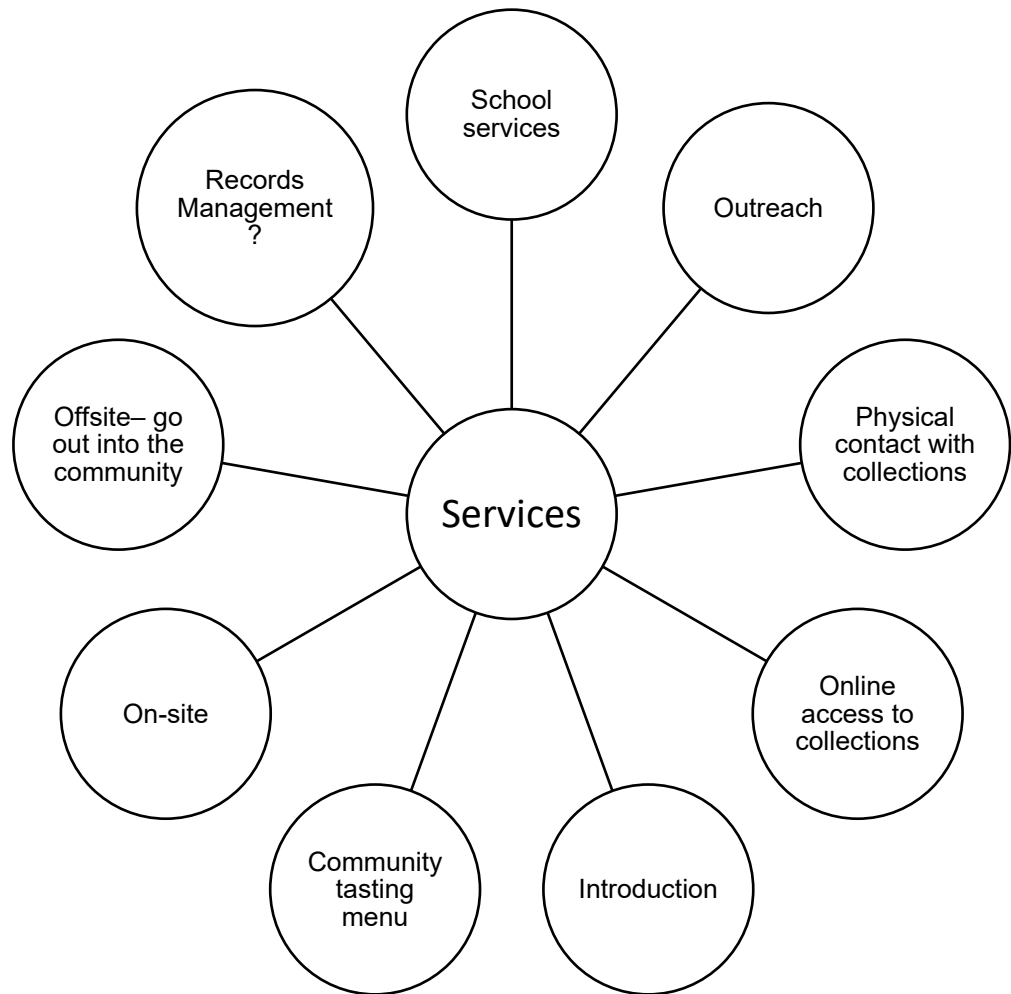

#### 4. Desired impacts

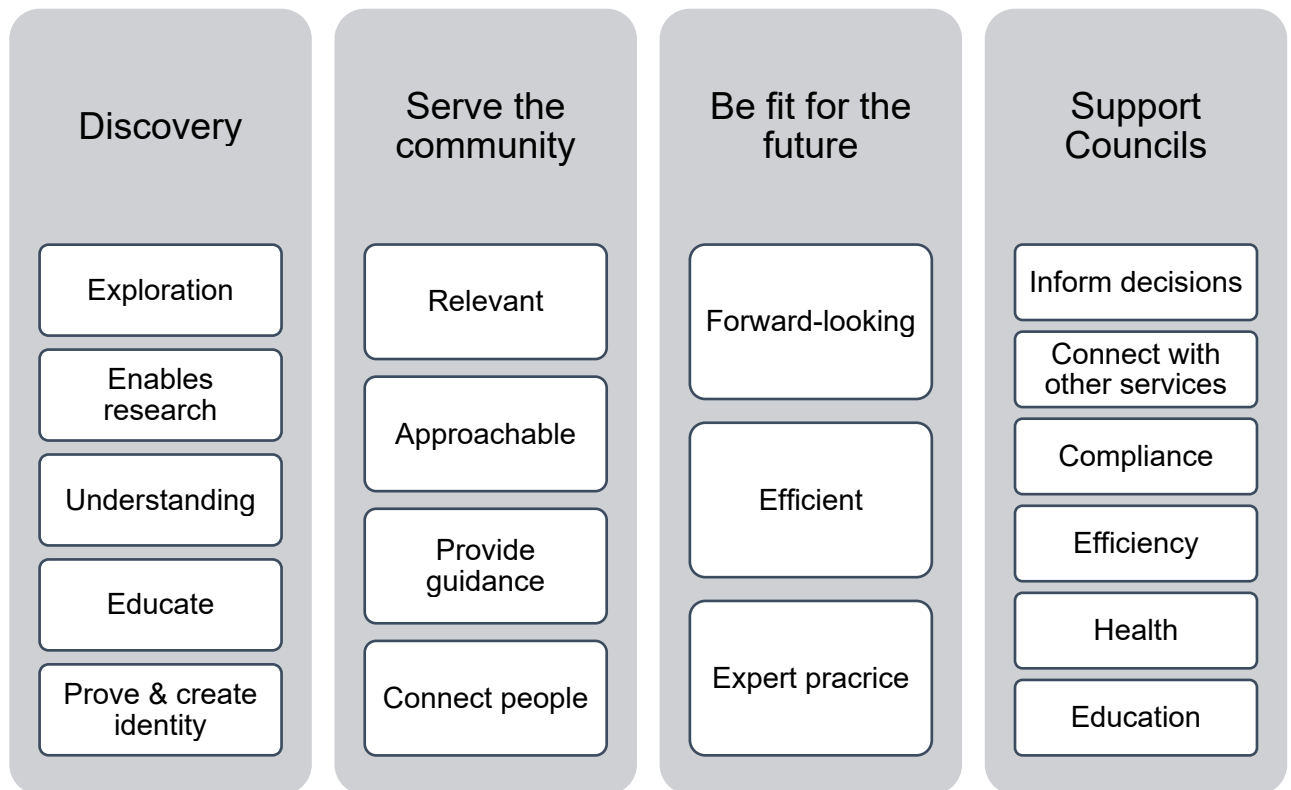

### 5. Potential 'markets' for services

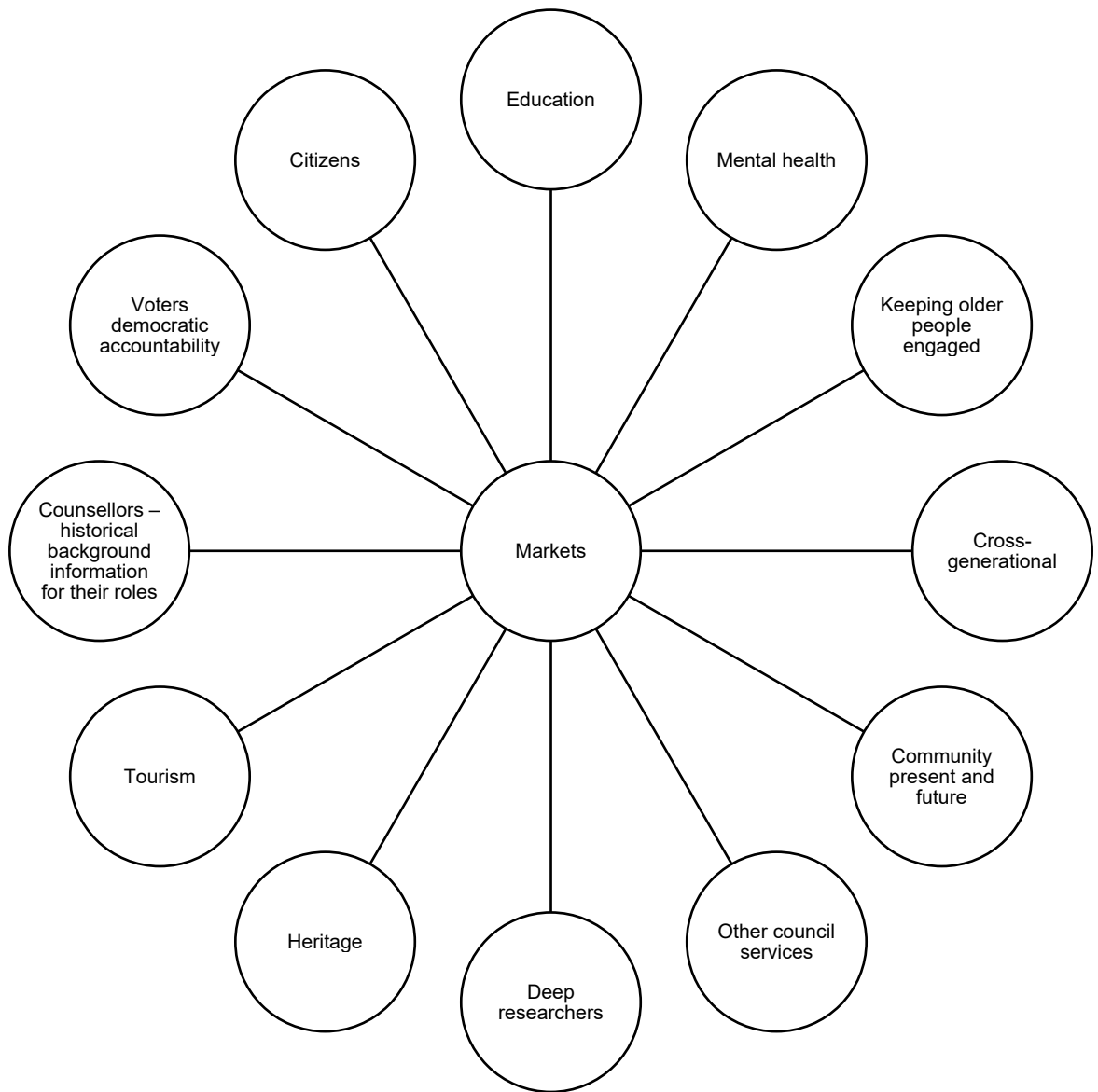



## 6. Channels of delivery

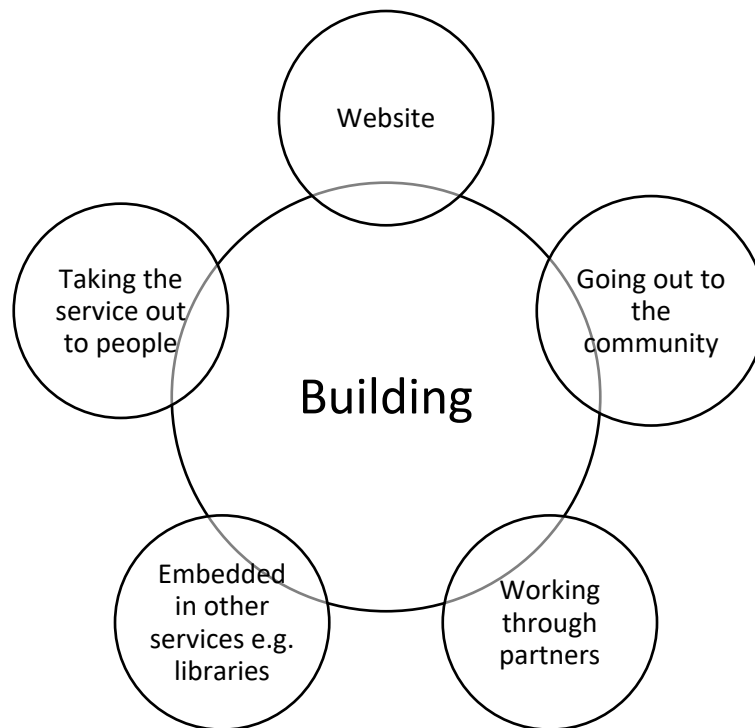

### Attributes of the archive building

<p>Encourage entry</p>	<ul style="list-style-type: none"> <li>• Route to entry is part of the civic space</li> <li>• Outdoor space</li> <li>• Welcoming - not clinical, soft architecture</li> <li>• Fun and engaging (dig up your archive!)</li> <li>• Cafe?</li> </ul>
<p>Practical &amp; sustainable</p>	<ul style="list-style-type: none"> <li>• Flexible spaces</li> <li>• Capacity for group activities</li> <li>• Clean, simple design</li> <li>• Location for developing services to take out to the community</li> <li>• Passivhaus design approach</li> </ul>
<p>Joined up</p>	<ul style="list-style-type: none"> <li>• Contextualised e.g. relates to neighbouring theatre</li> <li><input type="checkbox"/> Referenced from and linked into surrounding buildings e.g. Being in theatre in exhibition space</li> <li><input type="checkbox"/> Potential market links with local hotels, gyms, restaurants</li> </ul>

## 7. Digital functionality

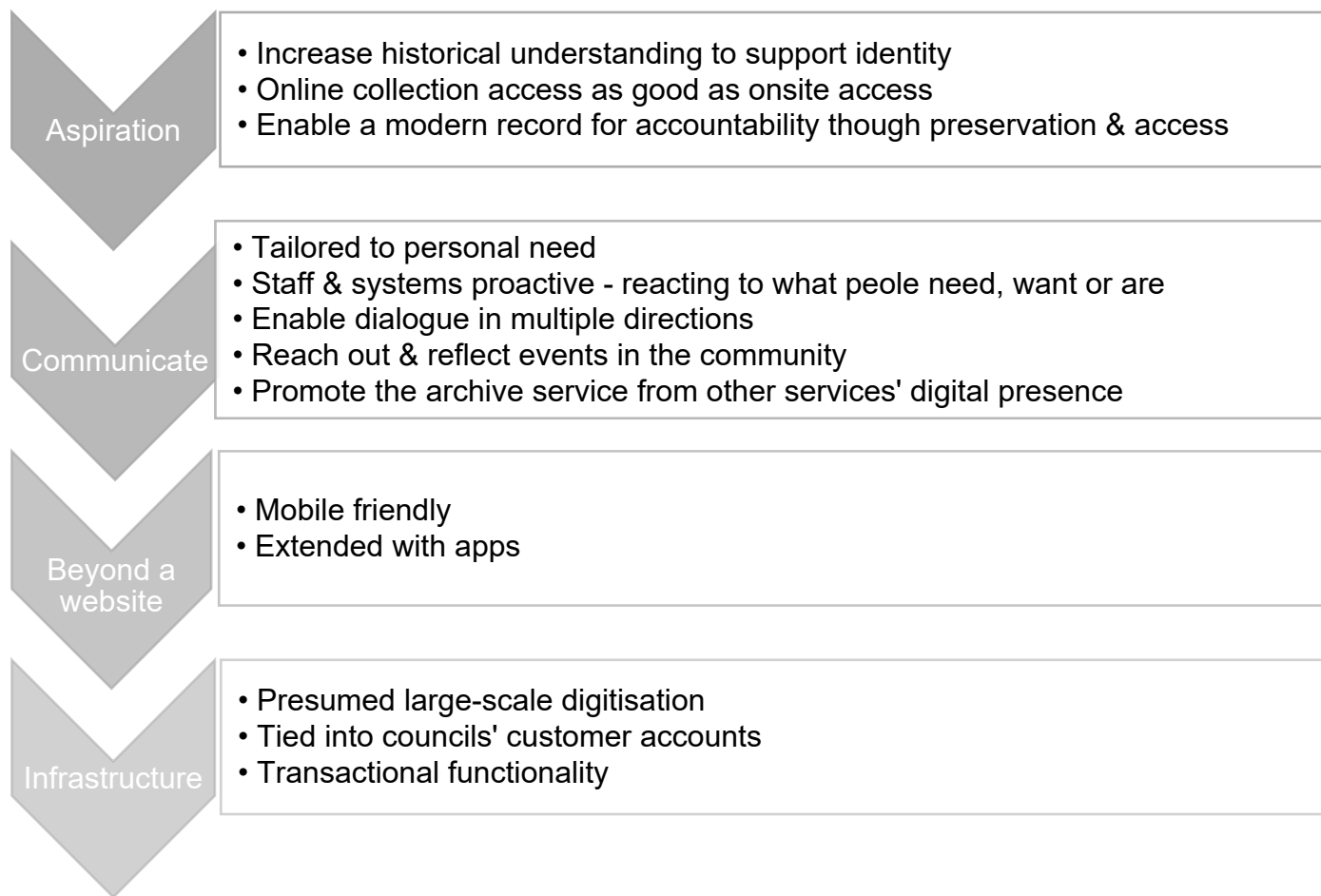

## 8. Vision ideas for an integrated service

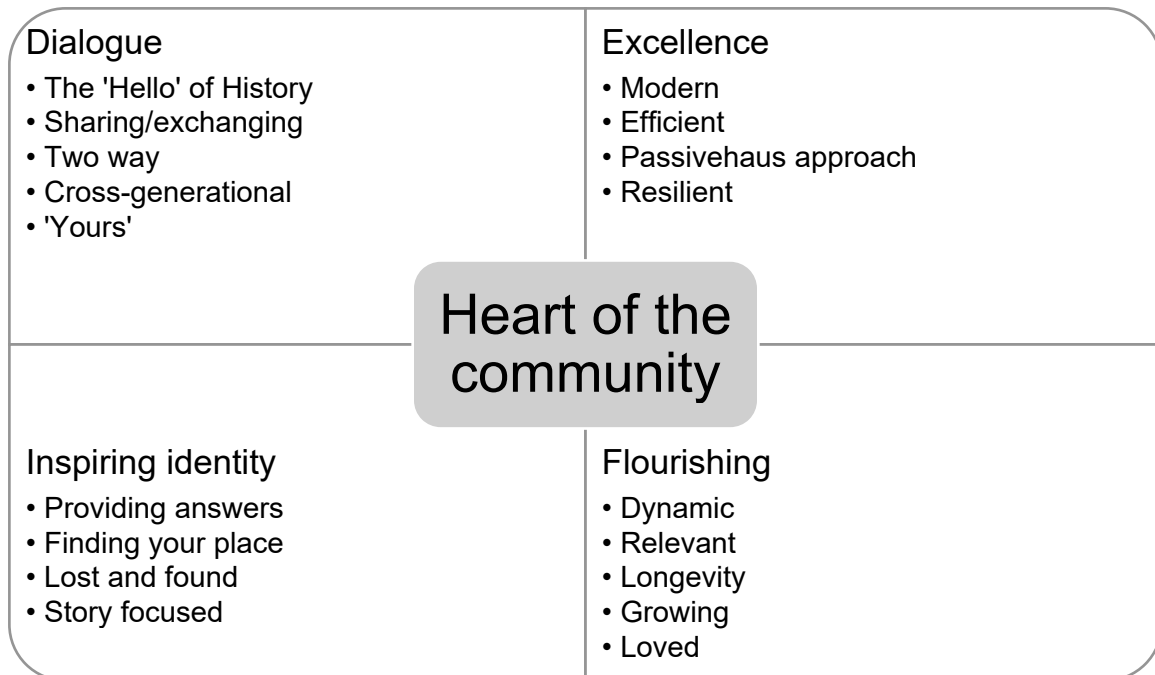

## 9. Analysis of stakeholder profiling for the joint service January 2019

### 19 stakeholders identified:

1. Universities
2. Schools
3. Friends group
4. Volunteers
5. Deep researchers - academics, researchers
6. Genealogists/local historians
7. Staff
8. Lead members
9. One off visitors
10. Universities as partners
11. Local clubs
12. unintentional users
13. Sponsors
14. Depositors
15. Public Records creators
16. 16-23 year olds Schools Universities
17. Library service
18. Adult Social Care/Council Services/ 3rd sector
19. Mental Health Provider

### Current level of engagement vs desired level

	Current engagement	Desired engagement
Staff	Continuous	Continuous
Volunteers	Continuous	Continuous
Genealogists/local historians	Continuous	Continuous
Schools	Regular	Frequent
One off visitors	Regular	Regular
Universities as partners	Regular	Continuous
16-23 year olds Schools Universities	Regular	Frequent
Universities	Occasional	Frequent
Friends group	Occasional	Continuous
Local clubs	Occasional	Regular
Unintentional users	Occasional	Regular
Sponsors	Occasional	Continuous
Public Records creators	Occasional	Regular
Library service	Occasional	Frequent
Adult Social Care/Council Services/ 3rd sector	Occasional	Regular
Mental Health Provider (Denbighshire)	Occasional	Continuous
Depositors	Very infrequent	Occasional

Appendix B

	<b>Current engagement</b>	<b>Desired engagement</b>
Deep researchers - academics, researchers	Very frequent	Continuous
Lead members	Very infrequent	Regular

Looking just at the desired level of engagement the pattern of engagement the services want to aim for is:

<b>Name or type of stakeholder</b>	<b>Desired level of engagement with the joint service</b>
Staff	Continuous
Volunteers	Continuous
Genealogists/local historians	Continuous
Universities as partners	Continuous
Friends group	Continuous
Sponsors	Continuous
Mental Health Provider (Denbighshire)	Continuous
Deep researchers - academics, researchers	Continuous
Schools	Frequent
16-23 year olds Schools Universities	Frequent
Universities	Frequent
Library service	Frequent
One off visitors	Regular
Local clubs	Regular
Unintentional users	Regular
Public Records creators	Regular
Adult Social Care/Council Services/ 3rd sector	Regular
Lead members	Regular
Depositors	Occasional

For most of the stakeholders the services want to increase the level of engagement. The biggest shifts in engagement they would like to see are:

	<b>Current engagement</b>	<b>Desired engagement</b>
Universities	Occasional	Frequent
Friends group	Occasional	Continuous
Sponsors	Occasional	Continuous
Library service	Occasional	Frequent
Mental Health Provider (Denbighshire)	Occasional	Continuous
Deep researchers - academics, researchers	Very frequent	Continuous
Lead members	Very infrequent	Regular

Key barriers to engagement were identified as:

- Location or travel distance
- Opening hours
- Availability of time to visit
- Lack of awareness of the archive services (hopefully somewhat reduced by FRO's move into Education and Youth portfolio)
- Lack of interest in what the services could provide
- Lack of storage space to accept collections (e.g. from public record creators in Flintshire).
- Staff time – particularly for managing volunteers
- Other priorities competing for the attention of Lead Members
- Uncertainty about rules for accepting financial donations
- Funding restricting both the archive services and potential partners from working together
- Difficulty of building relationships with continuous changes in personnel especially in local authority bodies

### **Benefits for target stakeholders**

These are varied but focus around opening up historical resources and the impact of doing so, taking the impact of archives beyond just more knowledge to wider social and health effects, and creating a place (real and virtual) with relationships, partnerships and communities can flourish:

- Vastly improve access to collections
- Source material for a massive variety of research topics
- Providing new sources for education
- Improve educational standards and widen knowledge
- Guidance and assistance in conducting research
- Meeting others with similar research interests
- Access to corporate memory
- Develop an initial or wider interest in heritage
- Assure legal compliance for the Councils
- Greater efficiency through better managed records
- Enhanced longevity of collections through better managed records
- A secure place for the deposit of the stakeholder's historical records and thus attract more historical records to boost the historical collections
- Storage accommodation that meets professional standards
- Health and well being
- Provide opportunities to experience personal history
- Supporting the community
- Engage the community in its own heritage
- Creating a place for individuals and groups to make contact with their wider community
- Providing a conduit for the community to make contact with the university
- A place to meet both for individuals and groups
- A new service outlet for comparator services such as libraries

## Appendix B

- A mechanism for creating collaborative projects
- Good quality public amenities
- Work experience placements including for university students
- Introduction to archiving and conservation as careers
- Bringing history to life for children
- Increased membership for Friends
- Provision of talks etc. to Friends
- A place for the Friends to gather
- Promotion of the services and councils
- Possible tax benefits for benefactors
- Attract more users to partner services
- Enable partner services to offer a wider experience to their visitors

The following word cloud gives some sense of the greatest benefits to stakeholders as the services see them:



## **Type of service/function the joint service could provide to deliver that stakeholder benefits**

### *Opening up access to the counties' archive collections*

- Sufficient opening hours that do actually invite and enable meaningful engagement with the collections
- Accessible collections i.e. sufficiently catalogued and described
- Guidance and advice regardless of the experience or background of the user
- Providing interpretation of archival resources suitable to the audience's/user's capacities and needs
- Share knowledge between the archive service and stakeholders and between stakeholders e.g. sharing research interests
- Access to microfilm/microfiche
- Training/introductory /taster sessions
- Creating opportunities across stakeholders to engage with collections
- Exhibitions
- Leaflets/publications about the service
- Engaging outreach such as talks
- One-off events such as Open Doors
- Reminiscence and nostalgia sessions
- Working across collections both from with the two archive services and with collections from other services e.g. local museums, other Welsh record offices, library collections
- Training staff in other services to understand, promote and even use the archive collections

### *Going beyond history to supporting the community and its members*

- Volunteering and work placements
- Engaging with reminiscence work
- Work experience - conservation, IT and media

### *Broadening education and assisting schools*

- Group visits to study original documents, tours of the building and other activities
- On-line resources for class use.
- Staff visits to schools.

### *Supporting further and higher education*

- Participation in education of students
- archive introduction to the collections and research

### *Nurturing research*

- Raise awareness amongst university students of the service as a source of original material for t research.
- Exhibition space for academic research (to meet Impact Assessment requirements for academic research)



*Being a destination*

- Provide meeting space

*Enable collecting and secure collections*

- Storage of records from depositors
- Creation and storage of university
- Remaining a Place of Deposit

*Supporting the supporters*

- Staff time to support the development of a friends' group or another form of supporters' organisation

*Enabling its own resilience*

- Enabling donations
- Generating publicity
- Driving advocacy
- Providing assurance/agreement of use of financial support

**Skills required of the joint service**

The joint service will have to both maintain its archival skills (and be able to move into managing and accessing digital collections as well as analogue) and learn or access the skills required to reach new audiences, work with new partners and effectively manage all aspects of the new service.

*Learning how to work with other professions*

- Academics
- Teachers
- Healthcare especially around mental health

*Skills for specific audiences*

- Working with children
- Supporting education
- Dementia patients
- Mental health

*Maintaining a high level of archival skills*

- Constant development of relevant archive skills relevant to a post holder's responsibilities

*Knowledge of core processes where they impact on a role within the service e.g.*

- Donating collections
- Archive collection management

*Core general operational skills*

- Marketing
- IT
- Customer service
- Presentation skills

*Vital 'soft' skills*

- Interpersonal skills

*Knowing the collections inside out*

Staff from each service having a good working knowledge of collections from both services

*Generating an attractive culture amongst the service staff*

- Knowledgeable
- Enthusiastic
- Committed
- Professional

**External input required**

The joint service will need the resources, experience contacts and knowledge of others to help it thrive and reach its potential. The following areas suggest where some of those key inputs will come from

*Building and strengthening external relationships*

- Closer working with universities - Bangor (e.g. Institute for the Study of Welsh Estates), Glyndwr and Chester.
- Working with ELY staff
- Individual schools and teachers.
- Local businesses
- Local organisations
- Building relationships with third parties who can connect the joint service with particular stakeholders e.g. to create contacts with hard-to-reach communities
- friends website development
- Funders

*A workable location*

- Good transport links
- Central location

*A known service*

- Building partnerships (see above)
- Signposting from other services and partners
- Advocacy by bodies outside of the archive service both inside and outside the councils

## Appendix B

### *A resilient service*

- Diverse funding base
- Funding for all the services' activities e.g. conservation, outreach, community engagement, collection management
- Provide staff with sufficient time to build relationships, learn and apply new skills

### *A service with current, relevant knowledge*

- Training for staff to work with external partners and new audiences
- Keeping staff updated and capable around legal requirements from legal professionals
- Up-to-date training in educational curricula and needs from teaching professionals
- Up-to-date training in good practice in chosen areas of activity e.g. mental health

## **Key collections for future engagement with chosen stakeholders**

The following collections have been identified as having particular interest for stakeholders and this can be used to programme work to improve access to collections e.g. cataloguing, exhibitions, online resources, educational material

- Hospitals
- Estate records
- Schools
- Newspapers
- Census records
- Maps
- Photographs
- Name rich resources such as electoral registers, parish registers, quarter sessions
- Council records
- Solicitors,
- Coroners
- Courts
- Police
- Clubs and groups

For any level of academic research the whole body of collections is important to provide the capacity to range across topics and provide depth

Mae'r dudalen hon yn wag yn bwrpasol

## **Basis of the Joint Archive Service relationship**

It is one of the overriding principles that the **Parties should not end up with a service which costs more than it currently does to provide.** So for the cost of operating the single shared service, the organisation currently paying the least will represent the common denominator and the corresponding percentage contribution calculated from that. For example, DCC has the lowest current operating budget and therefore represents 40%. If this is less than FCC is currently paying, that Party may choose to contribute more to the single shared service but they would not be obliged to.

In respect of the operation of the asset outside the county boundary, during the life of the building it is proposed that FCC to retain freehold for the land and the building and DCC will enter into a lease with FCC outlining clearly the terms of the shared occupation of the building. This lease would be for 25 years to begin with, pepper corn rent, and periodic review periods and the opportunity to renew at the end of 25 years or expire. Cost sharing will be done based on population- currently 60/40 and reviewed in light of any new census data. Considering the end of life of the building, it is proposed that DCC would not seek any return from sale or otherwise of the asset as the initial investment of capital by DCC, over the 25 years of operation, would have delivered a benefit to the organisation over and above any sort of return from sale.

Mae'r dudalen hon yn wag yn bwrpasol

### 3. Project management

Below is the proposed Project Management structure.

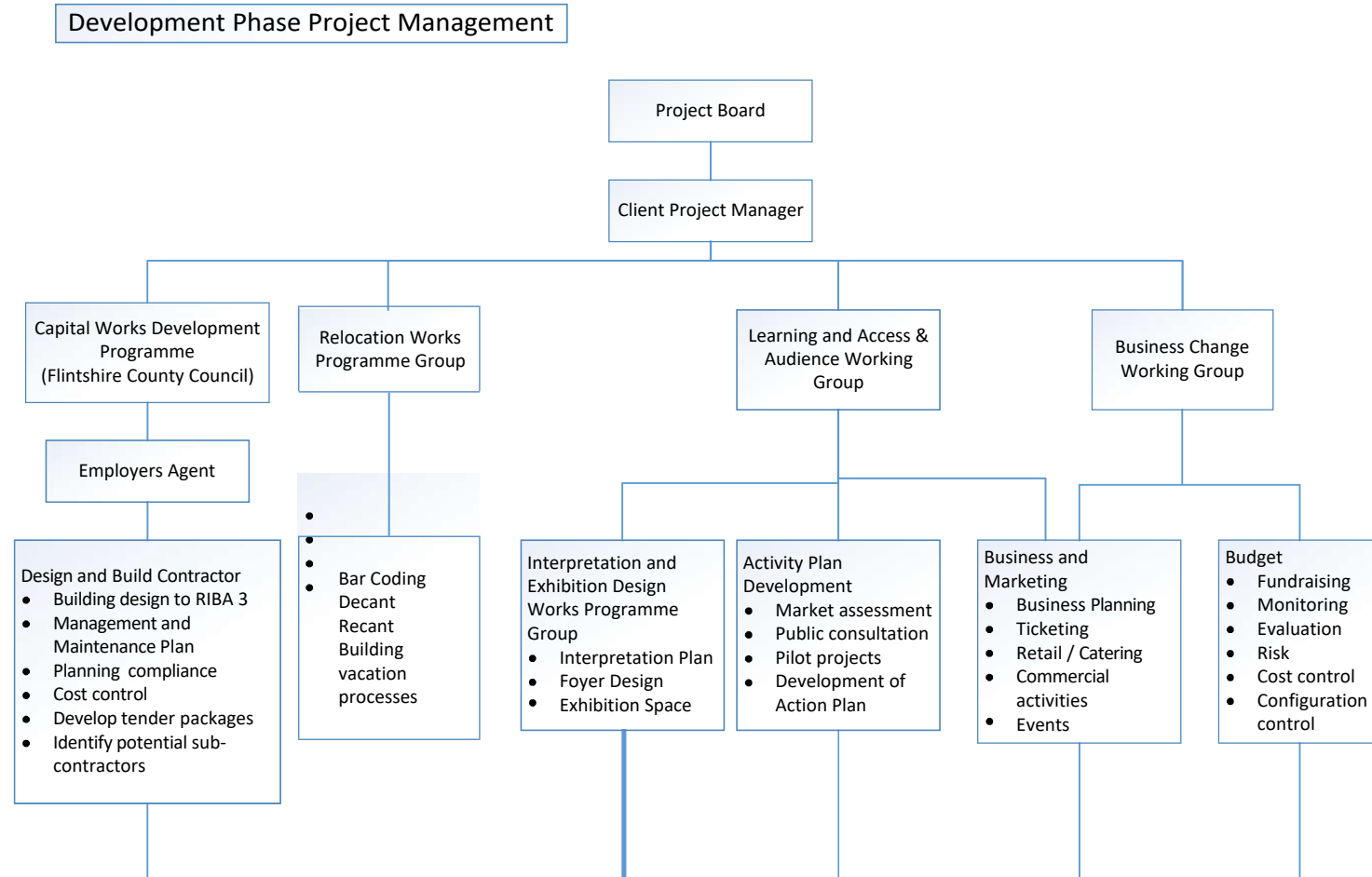

Tudalen 255

Mae'r dudalen hon yn wag yn bwrpasol



**MAJOR RISKS TO THE PROJECT**

A summary of the key risks associated with the project together with the likely impact and plans should they occur is provided below:

Title	Inherent Risk	Mitigating Action	Residual Risk
The project costs exceed the funding available	B2	Construction costs and programme for the project were updated in July 2023, and include contingency @ 15% and inflation based on BCIS Index. An element of inflation has been factored into other costs such as ICT, decant/recant, and staff costs. A separate client contingency of £500k has also been included in the costs. HLF funding contracted in 2 phases, development phase RIBA 1-3 and then delivery phase. Opportunity to sense check costs and risks at RIBA 3.	C2
HLF Grant funding application is not successful	D1	Expression of Interest for the project was accepted in December 2023, and the project meets the current grant criteria. Good dialogue and advice has already been provided by the Welsh Capital Grant funding team, and there is in principle support for the project.	D1
WG transitional grant funding application is not successful	C3	WG Culture division is aware and supportive of the project, and have advised that would welcome an expression of interest in 2024, with a view to drawing down capital grant funding in yr 2 (2026).	D3
Local Authority match funding for the project cannot be secured	D3	FCC Cabinet approved their proportion of the match funding in September 2019, and their support for the revised project was reiterated in January 2023. DCC have yet to approve their proportion of the match funding, and some considerable work has been undertaken recently to evaluate the options, given that there is a need to do something.	E4

Appendix E

Tudalen 258

Title	Inherent Risk	Mitigating Action	Residual Risk
Timescales for the project are exceeded	B3	Construction programme has been well considered, and grant funders have stated response times which have been built in. Need to ensure that the project is adequately supported by both authorities to ensure that there are no delays in the contractual relationships between the authorities, which could potentially delay the project. Project risks need to be effectively managed.	B4
Scope of the construction element of the project is exceeded	C2	Costs based on concept design, and within a plot defined by FCC. Prior to the acceptance of any grant funding scope of Joint archive building, and its curtilage needs to be confirmed. Changes to scope mutually agreed.	C4
Ineffective Risk Management	B3	Project risks are generally assigned to the party best placed to manage them. Consideration of risk register and assign risks to relevant parties. Adequate resource made available by client to proactively manage risks.	D3
Roles and responsibilities of both authorities are not fully understood and adhered to	C2	Prior to the acceptance of any grant funding DCC and FCC will need to enter into a contract in respect of the delivery of the capital project, and agree a basis of understanding for the shared costs of the joint archive relationship for the operation of the service and the occupation of facility, in return for DCC's financial investment in a FCC asset.	D2
Archive Service revenue assumptions for the delivery of the project and the ongoing sustainability of the service aren't realistic	C2	Consideration of revenue budgets and contractual arrangements in place to enable both authorities to manage expectations in relation the new joint service delivery	D2

Appendix E

Title	Inherent Risk	Mitigating Action	Residual Risk
Partnership breakdown between FCC and DCC	D1	Contract between both authorities to govern the relationship in build and in operation. Will include exit strategy and process within the contractual terms.	D2
Unforeseen site conditions on the proposed site for the new build	C2	Feasibility work has been undertaken, and there is provision for some abnormal costs within the budget related to ground conditions, as well as a construction contingency and a client contingency.	C4

	A - Almost Certain				
	B - Highly Likely				
Likelihood	C - Probable				
	D - Possible				
	E - Rare				
	5 - Very Low	4 - Low	3 - Medium	2 - High	1 - Very High
	Impact				

Mae'r dudalen hon yn wag yn bwrpasol

## Appendix F

<b>Cost Summary</b>	
<u>Expenditure Budget</u>	
Construction Costs	£ 11,491,769.61
Additional Project Costs	£ 1,003,903.55
Activity Plan	£ 306,620.39
Volunteering	£ 90,000.00
<b>TOTAL EXPENDITURE</b>	<b>£ 12,892,293.55</b>
<u>Income</u>	
Welsh Heritage Lottery Funding	£ 7,371,397.00
FCC Match Funding	£ 3,078,537.93
DCC Match Funding	£ 2,052,358.62
Volunteers	£ 90,000.00
WG Culture & Leisure Dept funding	£ 300,000.00
<b>INCOME TOTAL</b>	<b>£ 12,892,293.55</b>

Mae'r dudalen hon yn wag yn bwrpasol

# Eitem ar gyfer y Rhaglen 8



## CABINET

<b>Date of Meeting</b>	Tuesday 16th January, 2024
<b>Report Subject</b>	Revenue Budget Monitoring Report 2023/24 (Month 8)
<b>Cabinet Member</b>	Cabinet Member for Finance, Inclusion, Resilient Communities including Social Value and Procurement
<b>Report Author</b>	Corporate Finance Manager
<b>Type of Report</b>	Operational

### EXECUTIVE SUMMARY

This monthly report provides the latest detailed overview of the budget monitoring position for the 2023/24 financial year for the Council Fund and Housing Revenue Account and presents the position, based on actual income and expenditure as at Month 8.

The projected year end position is as follows:

#### **Council Fund**

- An operating deficit of £2.942m which is a favourable movement of £0.728m from the deficit figure reported at Month 7.
- A projected contingency reserve available balance as at 31 March 2024 of £4.918m. (after the actual impact of pay awards and taking account of previously approved allocations).

#### **Housing Revenue Account**

- Net in-year revenue expenditure is forecast to be £0.018m higher than budget which is an adverse movement of £0.118m from the figure reported at Month 7.
- A projected closing balance as at 31 March, 2024 of £3.297m

The economic outlook remains challenging due to inflation levels remaining high.

The impacts of this, together with continued increases in service demand is becoming increasingly hard to deal with as our funding fails to keep up with the scale of these pressures.

To assist with managing these risks and mitigating the overall projected overspend, a moratorium on non-contractually committed spend has been put in place alongside a vacancy management process which continues.

At Month 8, £1.293m of deferred and/or delayed expenditure has been identified and is analysed by service within Appendix 2. The robust challenge of budget lines and commitments will continue, and further updates provided in future reports.

## RECOMMENDATIONS

1	To note the report and the estimated financial impact on the 2023/24 budget.
---	--

## REPORT DETAILS

<b>1.00</b>	<b>EXPLAINING THE REVENUE BUDGET MONITORING 2023/24</b>
1.01	<p>The projected year end position is as follows:</p> <p><b>Council Fund</b></p> <ul style="list-style-type: none"> <li>An operating deficit of £2.942m which is a favourable movement of £0.728m from the deficit figure reported at Month 7.</li> <li>A projected contingency reserve available balance as at 31 March 2024 of £4.918m (after the actual impact of pay awards and taking account of previously approved allocations).</li> </ul> <p><b>Housing Revenue Account</b></p> <ul style="list-style-type: none"> <li>Net in-year revenue expenditure forecast to be £0.018m higher than budget which is an adverse movement of £0.118m from the figure reported at Month 7.</li> <li>A projected closing balance as at 31 March, 2024 of £3.297m</li> </ul> <p>To assist with managing these risks and mitigating the overall projected overspend, a moratorium on non-contractually committed spend has been put in place alongside a vacancy management process which continues.</p> <p>At Month 8, £1.293m of deferred and/or delayed expenditure have been identified and is analysed by service within Appendix 2. The robust challenge of budget lines and commitments will continue, and further updates provided in future reports.</p>
1.02	<p>Hardship Funding from Welsh Government helped secure £16m of direct financial help in 2022/23 for areas such as self-isolation payments, statutory sick pay enhancement, free school meals direct payments and winter fuel payments. However, this funding ceased on 31 March 2023.</p>



1.03 **Table 1. Projected Position by Portfolio**

The table below shows the projected position by portfolio:

Portfolio/Service Area	Approved Budget	Projected Outturn	In-Year Over / (Under) spend
	£m	£m	£m
Social Services	89.235	89.905	0.670
Out of County Placements	17.285	18.812	1.526
Education & Youth (Non-Schools)	10.289	9.923	(0.367)
Schools	114.081	114.313	0.232
Streetscene & Transportation	42.227	43.694	1.467
Planning Env & Economy	7.557	6.880	(0.678)
People & Resources	4.697	4.501	(0.195)
Governance	11.943	11.718	(0.225)
Assets	11.141	10.817	(0.324)
Housing & Communities	15.990	18.714	2.724
Chief Executive	1.672	1.667	(0.005)
Central & Corporate Finance	26.003	24.120	(1.882)
<b>Total</b>	<b>352.121</b>	<b>355.064</b>	<b>2.942</b>

The changes made to the approved budget since Month 7 relate to the disaggregation of the Pay Award budget (Non Schools) previously held Corporately now allocated proportionately to Portfolios.

1.04 The reasons for the monthly movements over £0.025m are shown in Appendix 1 and overall projected variances over £0.050m are summarised within Appendix 2 together with a summary of minor variances for each portfolio.

**Significant Movements from Month 7**

1.05 **Out of County £0.190m**

The adverse movement relates to:

- Children's Services £0.231m - Net impacts of new placements, changes of placements, ended placements and reduction of contingency provision.
- Education & Youth (£0.041m) - Net impacts of new placements, changes of placements and reduction of contingency provision.

1.06	<p><b>Education &amp; Youth (£0.181m)</b></p> <p>The favourable movement relates in part to the Inclusion and Progression Service identifying further savings of (£0.110m).</p> <ul style="list-style-type: none"> <li>• Within the Additional Learning Needs (ALN) service previously committed spend to cover the ALN Band C overspend within Primary Schools from the Local Authority Education Grant for ALN has now become available, therefore maximisation of the grant has allowed the Council to fund the Band C pressure within schools, releasing base budget as a saving (£0.055m).</li> <li>• Within the EAL/Traveller Service a £0.095m budget from 2022-23 was agreed to be carry forward to be used for Trauma Training. One course has been run at a reduced cost of £0.035m. The service has decided not to run any future courses, therefore leaving an underspend of the carry forward balance of (£0.060m).</li> </ul> <p>There is a further movement is within Schools Improvement Service where further savings of (£0.034m) have been identified.</p> <p>Minor variances across the Portfolio account for the remainder (£0.037m).</p>
1.07	<p><b>Streetscene &amp; Transportation (£0.130m)</b></p> <p>The favourable movement relates to:</p> <p><b>Transportation</b></p> <ul style="list-style-type: none"> <li>• Vacancies and impact of moratorium on spend (£0.089m).</li> </ul> <p><b>Regulatory Services</b></p> <ul style="list-style-type: none"> <li>• Vacancies and impact of moratorium on spend (£0.072m).</li> </ul> <p>Minor variances across the Portfolio account for the remainder £0.031m</p>
1.08	<p><b>Planning Environment &amp; Economy (£0.154m)</b></p> <p>The reasons for the favourable movement are as follows:</p> <p>Staff savings from vacant posts across the Portfolio together with the maximisation of Grant Income for Countryside Projects (£0.136m).</p> <p>Minor variances across the Portfolio account for the remainder (£0.018m).</p>
1.09	<p><b>Governance (£0.086m)</b></p> <p>The favourable movement relates to the delayed / deferred expenditure across the Portfolio, savings from vacant posts, reduction in the employer contribution percentage for Superannuation pension costs within Member Services and a slight increase in projected fee income (£0.117m). This is mitigated by an adverse movement in the projected Surplus on the Council Tax Fund resulting from potential exemptions following the impact of the recent Storms £0.031m.</p>

1.10	<p><b>Assets (£0.115m)</b></p> <ul style="list-style-type: none"> <li>Corporate Property Maintenance &amp; Design Services (£0.098m) due to increased fee income.</li> </ul> <p>Minor variances across the Portfolio account for the remainder (£0.017m).</p>
1.11	<p><b>Central &amp; Corporate (0.239m)</b></p> <p>Following an update on the Central Loans &amp; Investment Account (CLIA), with continuing increased income from investments and reduced borrowing, a further favourable movement of £0.250m is reported at Month 8.</p> <p>Minor variances account for the remainder £0.011m.</p>
1.12	<p>Cumulative minor variances across the Council of (£0.028m) account for the remainder of the total monthly movement.</p>
1.13	<p><b>Tracking of In-Year Risks and Emerging Issues</b></p> <p>Members were made aware when setting the budget that there were a number of open risks that would need to be kept under close review. An update on these is provided below.</p>
1.14	<p><b>Council Tax Income</b></p> <p>The 'in-year' collection level is 75.2% compared to 75.3% the previous year. The reduction in collections of 0.1% is mainly because the rising costs-of-living are impacting on the ability of some households to make payment of council tax on time. Other local authorities in Wales are also seeing similar, if not greater, reductions in collections.</p>
1.15	<p><b>Pay Award (Teacher and Non-Teacher)</b></p> <p><u>NJC (Green Book)</u></p> <p>The actual impact of the pay offer for 2023/24 was an additional £2.702m compared to the estimated £2.727m that was referred to previously.</p> <p><u>Teachers Pay</u></p> <p>Increases as previously outlined have been accepted by all teaching unions.</p>
1.16	<p><b>Pay Modelling</b></p> <p>No figures are currently included for any impact of the pay modelling review which is needed to try and address the difficulties currently being experienced in recruitment and retention. It is due to be completed later this year.</p>
1.17	<p><b>Waste Recycling Infraction Charge</b></p>

	<p>The Council did not meet the statutory minimum target, (64%) in 2021/22, for the percentage of municipal waste which must be recycled, prepared for re-use and composted, as specified in Section 3 of the Waste (Wales) Measure 2010. Welsh Government can therefore take steps to impose a penalty on the Council by way of an infraction fine. A potential penalty of up to £0.663m has been confirmed so presents a significant financial risk to the Council.</p> <p>Discussions took place in March,2023 between Welsh Government (WG) and the Council as to the reasons for not achieving the target. The Council has subsequently been instructed by WG to engage with the Waste and Resources Action Programme (WRAP) and Local Partnerships to review our waste strategy and develop a new action plan. Depending on the outcome of the review, the Minister will take a decision at that point whether to levy the fine.</p> <p>Unfortunately, the statutory recycling targets have not been achieved in 2022/23 too (non-verified), which means that a further infraction fine could be levied of around £0.470m should WG choose to do so, and monitoring of the authority's recycling performance for 2023/24 to date shows that the rates of recycling and residual waste tonnages are not improving, which could lead to not achieving the targets in 2023/24 also.</p>
1.18	<p><b>Homelessness</b></p> <p>There is a significant and growing demand within the Homelessness service. The Council has a statutory duty to provide suitable temporary accommodation for Homeless persons and families who meet the Welsh Government eligibility criteria which are less stringent than in England. The growth in demand commenced in the second half of 2022/23 and has accelerated markedly since the start of 2023.</p> <p>One of the more significant influences of many is the sparsity of affordable accommodation in the private rented sector which is being influenced by the cost-of-living crisis and an increase in the numbers of no-fault evictions as many private rented sector landlords are leaving the sector and seeking to sell their properties. There is also an acute shortage of suitable available accommodation within the Council's own HRA housing stock and with other Registered Social Landlords (RSL's) within the area. This is particularly the case for single persons below age 55 which make up the highest proportion of those who are currently homeless in Flintshire. The Flintshire position in terms of both demand and supply pressures is known to be consistent on both a regional and national basis within Wales.</p> <p>The Council will continue to lobby Welsh Government via the WLGA in conjunction with other Welsh LA's who are experiencing these pressures to seek additional financial support.</p> <p>WG are currently providing support via the No One Left Out grant for which the 2023/24 allocation is currently £0.382m. One favourable impact of the increase in costs and demand is the ability to recover additional Housing</p>

Benefit income over and above the amount budgeted which is currently helping to offset the projected overspend by £0.447m.

A separate report on the issues and potential mitigations around homelessness was considered by Community and Housing Overview and Scrutiny Committee in November.

**1.19 Storm Babet**

Storm Babet was an intense extratropical cyclone which affected many parts of the County from 19 October through to the end of 21 October 2023. This was followed rapidly by Storm Ciaran, which although saw less impact, still necessitated significant resources in response.

The storm caused severe disruption to travel with many roads closed, railways flooded, schools closed, and properties being affected by flood water. Storm Ciaran also required a priority response and caused some additional costs.

The Council has been incurring the financial impact of the emergency response, assessing damage to infrastructure and arranging the necessary remedial works to be carried out in the aftermath. This is currently estimated at £1m.

There is an Emergency Financial Assistance Fund (EFAS) that Welsh Government have in place. However, Authorities are expected to make reasonable provision in their budgets to deal with contingencies. Therefore, if an Emergency Financial Assistance Scheme is activated, the authority affected will be expected to meet all eligible expenditure up to the level of its threshold.

Thresholds are calculated at 0.2% of authority's annual budget requirement and apply to the whole financial year, not to each incident within the financial year and for Flintshire, this amounts to emergency funding being provided at 85% for costs over and above the threshold of £0.711m. WG have been notified of our intention to allocate the costs against the EFAS scheme, which will require Minister approval.

There is a Severe Weather Earmarked Reserve totalling £0.250m which can assist in funding some of these costs.

The financial impact of Storms Babet and Ciaran is estimated as follows: -

Description	Costs to date £m	Projected future costs £m	Total Costs £m
Clean Up	0.300	0.150	0.450
Priority re-instatement works		0.500	0.500
Other storm damage costs		0.050	0.050
<b>Total Projected Costs</b>	<b>0.300</b>	<b>0.700</b>	<b>1.000</b>
<b>Severe Weather Reserve</b>			<b>-0.250</b>
<b>EFAS Funding @ 85%*</b>			<b>-0.246</b>

	<b>Projected net cost of storms</b>			<b>0.504</b>
*£1.0m less £0.711m threshold = £0.289m x 85% = £0.246m				
1.20	<b>Other Tracked Risks</b>  In addition, there are a number of risks being tracked which may be subject to change and these are summarised below.			
1.21	<b>Medium Term Financial Strategy (MTFS) Impact</b>  The Council received its provisional Welsh local government settlement on 20 December as planned and a separate report on this agenda provides an update on budget planning for 2024/25.  All Portfolios consider their financial position, the risks within their service and the impacts on the Medium Term on a monthly basis as part of their Portfolio Management Team meetings.			
1.22	<b>Out of County Placements</b>  The risks include continued high demand for placements where children and young people cannot be supported within in-house provision, and market supply limitation factors and inflationary pressures leading to higher costs. An additional amount of £1m was approved in the 2023/24 budget to reflect this.  However, there remains a projected overspend for the current cohort of placements of circa £1.526m, although with 4 months of the year remaining this is likely to increase and a contingency of £0.200m is currently built into the outturn position for this, £0.100m for Children’s Services and £0.100m for Education placements.  The service areas within this pooled budget will continue to do everything possible to manage these risks and additional investment has already been made to further develop in-house provision to help to mitigate against such financial pressures.			
1.23	<b>Streetscene &amp; Transportation</b>  <u>Fleet Contract Renewal</u> The current fleet contract, which has been in operation for 7 years, was renewed for a temporary period of 6 months from October 2023. Due to the current market conditions in re-procurement of contracts of this type, the cost of the new contract is considerably more than what was previously being paid, due to being protected from inflationary increases during the previous contract life. The cost of the contract will further increase from April 2024 and provision is being made within the 2024/25 budget considerations for this.  <u>Sustainable Waste Management Grant (SWMG)</u>  The Minister for Climate Change has confirmed that the SWMG grant will be retained at the same level for this financial year. However, those local authorities that are not yet meeting the statutory recycling target of 70% will			

	<p>be required to use the grant to reach 70% and be required to demonstrate this. It has also been confirmed that the SWMG grant will likely become part of the Revenue Support Grant (RSG) funding from 2024/25. The current value of the grant is £0.742m per annum, but it is not yet confirmed whether the proportion that Flintshire will receive within the Welsh Local Government settlement will be similar to current levels.</p>
1.24	<p><b>Education &amp; Youth (Non-Schools)</b></p> <p><u>Inclusion and Progression</u></p> <p>The services that the Inclusion and Progression teams provide within Education and Youth portfolio are under significant pressure.</p> <p>Prior to the pandemic the service had seen increasing numbers of children and young people presenting with an increased level of significant and complex needs, resulting in the council being dependent on non-Flintshire provision.</p> <p>Post pandemic the situation has worsened with increasing numbers of pre-school children needing support and challenging behaviour causing concern across both primary and secondary schools. In addition, there are increased rates of emotionally based school avoidance. As a result, levels of attendance have reduced, whilst all forms of exclusions have increased. All of which contributes to a requirement for more specialist and bespoke intervention.</p> <p>The service is taking steps to actively manage demand, alongside reviewing provision, and seeking to develop and enhance in house provision.</p> <p>The pressures are being experienced across Wales, at a time when schools and central services are implementing the Additional Learning Need (ALN) reforms.</p> <p>Welsh Government have made additional grants available to support schools and councils. However, there are risks over reliance on temporary grant funding and its ability to meet demand within existing budgets and available grants.</p>
1.25	<p><b>Harpur Trust vs Brazel Case</b></p> <p>The potential financial impacts are still being determined in response to the Employment Appeal Tribunal (EAT) decision in the case of Harpur Trust v Brazel. The Supreme Court upheld the EAT judgment in the Brazel case in July 2022 which impacts on the calculation of holiday pay entitlements for staff who work for part of the year (i.e., term time). An approved carry forward from 2022/23 for £0.254m will provide some funding towards these costs.</p>
1.26	<p><b>Achievement of Planned In-Year Efficiencies</b></p> <p>The 2023/24 budget contains £9.265m of specific efficiencies which are tracked and monitored throughout the year. The Council aims to achieve a 95% rate in 2023/24 as reflected in the MTFs KPI's and fully achieved all efficiencies in the previous financial year.</p>

	It is projected that 99% of efficiencies will be achieved in 2023/24 and further details can be seen in Appendix 3.
1.27	<p><b>Unearmarked Reserves</b></p> <p>The final level of Council Fund Contingency Reserve brought forward into 2023/24 was £9.508m as detailed in the 2022/23 outturn report (subject to Audit).</p> <p>The brought forward balance on the COVID-19 Hardship Reserve was £3.743m. Internal claims for Quarters 1 and 2 in 2023/24 totalling £0.531m for Holywell Leisure Centre, Cambrian Aquatics, Streetscene &amp; Transportation and Free School Meals covering the Christmas holiday period have been approved so far. The current balance remains at £3.212m.</p> <p>The projected contingency reserve available as at 31 March, 2024 is £4.918m (after the actual impact of final pay awards and previously approved allocations) and is shown in Appendix 4.</p>
1.28	<p><b>Housing Revenue Account</b></p> <p>The 2022/23 Outturn Report to Cabinet on 18th July 2023 showed an un-earmarked closing balance at the end of 2022/23 of £3.786m and a closing balance of earmarked reserves of £2.690m.</p>
1.29	The 2023/24 budget for the HRA is £39.418m which includes a movement of (£0.589m) from reserves.
1.30	<p>Net in-year revenue expenditure forecast to be £0.018m higher than budget with a projected closing balance as at 31<sup>st</sup> March, 2024 of £3.179m.</p> <p>This is an adverse movement of £0.118m since Month 7.</p> <ul style="list-style-type: none"> <li>• Repairs &amp; Maintenance increase in Sub Contractor spend £0.250m</li> <li>• Adjustment to bad debt provision (£0.075m)</li> <li>• Reduction in equipment hire in Laundries (£0.029m)</li> </ul> <p>Minor variances account for the remainder (£0.028m).</p>
1.31	The budget contribution towards capital expenditure (CERA) is £12.712m.

<b>2.00</b>	<b>RESOURCE IMPLICATIONS</b>
2.01	As set out within the report.

<b>3.00</b>	<b>IMPACT ASSESSMENT AND RISK MANAGEMENT</b>
3.01	The financial impacts as set out in the report are a combination of actual costs and losses to date and estimates of costs and losses for the future. There is the possibility that the estimates will change over time. The



	budget will be monitored closely, and mitigation actions taken wherever possible.
--	---

<b>4.00</b>	<b>CONSULTATIONS REQUIRED/CARRIED OUT</b>
4.01	None specific.

<b>5.00</b>	<b>APPENDICES</b>
5.01	Appendix 1: Council Fund – Movement in Variances from Month 7 Appendix 2: Council Fund - Budget Variances Appendix 3: Council Fund – Programme of Efficiencies Appendix 4: Council Fund – Movement on Un-earmarked Reserves Appendix 5: Housing Revenue Account Variances

<b>6.00</b>	<b>LIST OF ACCESSIBLE BACKGROUND DOCUMENTS</b>
6.01	Various budget records.
<b>7.00</b>	<b>CONTACT OFFICER DETAILS</b>
7.01	<b>Contact Officer:</b> Dave Ledsham Strategic Finance Manager <b>Telephone:</b> 01352 704503 <b>E-mail:</b> <a href="mailto:dave.ledsham@flintshire.gov.uk">dave.ledsham@flintshire.gov.uk</a>

<b>8.00</b>	<b>GLOSSARY OF TERMS</b>
8.01	<b>Budget:</b> a statement expressing the Council's policies and service levels in financial terms for a particular financial year. In its broadest sense it includes both the revenue budget and capital programme and any authorised amendments to them.  <b>Council Fund:</b> the fund to which all the Council's revenue expenditure is charged.  <b>Financial Year:</b> the period of twelve months commencing on 1 April.  <b>Housing Revenue Account:</b> the Housing Revenue Account (HRA) is a local authority account showing current income and expenditure on housing services related to its own housing stock. The account is separate from the Council Fund and trading accounts and is funded primarily from rents and government subsidy.  <b>Projected Outturn:</b> projection of the expenditure to the end of the financial year, made on the basis of actual expenditure incurred to date.

**Regional Integration Fund (RIF):** funding provided by Welsh Government to encourage integrated working between local authorities, health and housing.

**Reserves:** these are balances in hand that have accumulated over previous years and are held for defined (earmarked reserves) and general (general reserves) purposes. Councils are required to regularly review the level and purpose of their reserves and to take account of the advice of the Chief Finance Officer.

**Revenue:** a term used to describe the day-to-day costs of running Council services and income deriving from those services. It also includes charges for the repayment of debt, including interest, and may include direct financing of capital expenditure.

**Variance:** difference between latest budget and actual income or expenditure. Can be to date if reflecting the current or most up to date position or projected, for example projected to the end of the month or financial year.

**Virement:** the transfer of budget provision from one budget head to another. Virement decisions apply to both revenue and capital expenditure heads, and between expenditure and income, and may include transfers from contingency provisions. Virements may not however be approved between capital and revenue budget heads.

## Council Fund Variances

## MONTH 8 - SUMMARY

Service	Movement between Periods (£m)	Narrative for Movement between Periods greater than £0.025m
<b>Social Services</b>		
<b>Older People</b>		
Localities	0.138	Residential care costs have increased by £0.084m and domiciliary care costs increased by £0.132m, both of these are demand led services, There was a decrease in staffing costs of £0.077m as vacancies are to be filled later than previously planned.
Resources & Regulated Services	-0.106	There have been positive variances for residential care £0.044m, Extra Care £0.032m, Homecare £0.022 and Day Services £0.08m. Recruitment and retention continues to be challenging and prolonged recruitment delays lead to a reduction in costs for services.
Minor Variances	-0.033	
<b>Adults of Working Age</b>		
Resources & Regulated Services	0.055	There has been an overall increase to care packages costs within Disability Services.
Children to Adult Transition Services	-0.034	There is a decrease to the cost of care packages for young people transferring from Children's Services to Adult Social Care. As these care packages are new, an initial estimate is required and it is not uncommon for there to be differences between the cost of care package agreed and the initial estimate.
Professional and Administrative Support	-0.031	Delays to recruitment are resulting in longer time periods where posts are vacant.
Minor Variances	-0.071	
<b>Children's Services</b>		
Legal & Third Party	0.055	There has been an increase in legal costs which includes one high cost case.
Professional Support	0.049	Cost increases are due to increasing demand for Direct Payments for children with disabilities £0.032m and leaving care costs (which includes asylum seeking children) and agency costs £0.056m. These increases are being partially mitigated by a net decrease to overall employee costs of £0.039m.
Minor Variances	0.007	
<b>Safeguarding &amp; Commissioning</b>		
Minor Variances	-0.037	
<b>Total Social Services</b>	<b>-0.009</b>	
<b>Out of County Placements</b>		
Children's Services	0.231	Net impacts of new placements, changes of placements, ended placements and reduction of contingency provision
Education & Youth	-0.041	Net impacts of new placements, changes of placements and reduction of contingency provision
<b>Total Out of County Placements</b>	<b>0.190</b>	
<b>Education &amp; Youth</b>		
Inclusion & Progression	-0.110	Movement of £0.110m due to further savings identified. £0.050m within the Additional Learning Needs (ALN) service, which has funds committed to cover the ALN Band C overspend within Primary Schools. Previously committed spend from the Local Authority Education Grant for ALN has now become available, therefore we can maximise the grant by using it to fund the Band C pressure within schools, releasing base budget as a saving. A further £0.060m has been identified within the EAL/Traveller service. £0.095m budget from 2022-23 was agreed to be c/f to be used for Trauma Training One course has been run at a cost of £0.035m. The service have decided not to run any future courses, therefore leaving an underspend of the carry forward balance of £0.060m.
School Improvement Systems	-0.045	Movement of £0.034m within the School Improvement Service due to further grant funding. £0.027m from the Shared Prosperity Fund Multiply project. The service Manager for ACL (Adult Community Learning) has been co-ordinating the SPF project until the project manager is appointed. Additional £0.003m funding from the Citizens Curriculum grant and £0.004m for secondment work to Estyn.
Minor Variances	-0.026	
<b>Total Education &amp; Youth (Non-Schools)</b>	<b>-0.181</b>	
<b>Schools</b>	<b>-0.000</b>	
<b>Streetscene &amp; Transportation</b>		
Highways Network	0.026	Minor movements across the service
Transportation	-0.089	Vacancies and moratorium spend reductions are contributing to the overall positive movement.
Regulatory Services	-0.072	Vacancies and moratorium spend reductions are contributing to the overall positive movement.
Minor Variances	0.005	
<b>Total Streetscene &amp; Transportation</b>	<b>-0.130</b>	
<b>Planning, Environment &amp; Economy</b>		
Development	-0.021	Staff savings from vacant posts
Access	-0.057	Maximisation of Grant income for Countryside projects
Shared Services	-0.058	Staff savings from vacant post

Service	Movement between Periods (£m)	Narrative for Movement between Periods greater than £0.025m
Minor Variances	-0.018	
<b>Total Planning &amp; Environment</b>	<b>-0.154</b>	
<b>People &amp; Resources</b>		
HR & OD	-0.017	Staff savings from vacant posts
Corporate Finance	-0.024	Staff savings from vacant posts
<b>Total People &amp; Resources</b>	<b>-0.041</b>	
<b>Governance</b>		
Democratic Services	-0.020	Savings following a reduction in the employer superannuation contribution percentages for Members
Internal Audit	-0.031	Commitment for Agency cover removed in response to the moratorium, Reduction in Postage costs anticipated to March, 2024
ICT	-0.023	Staff savings from vacant posts £0.010m, delayed project following Moratorium £0.030m, minor variances across the Services.
Customer Services	-0.043	Staff savings from vacant post, Increase in projected fee income Registrars; Consultation and Engagement software deferred £0.015m
Revenues	0.031	Projected surplus on the Council Tax Collection Fund £0.150m reduced at Month 7 due to potential exemptions following the recent storms
<b>Total Governance</b>	<b>-0.086</b>	
<b>Assets</b>		
CPM & Design Services	-0.098	Due to increased fee income
Minor Variances	-0.017	
<b>Total Assets</b>	<b>-0.115</b>	
<b>Housing and Community</b>		
Housing Solutions	0.070	Net impacts of additional hotel costs and increased HSG allocation and other minor movements
Minor Variances	-0.020	
<b>Total Housing and Community</b>	<b>0.050</b>	
<b>Chief Executive's</b>	<b>-0.014</b>	
<b>Central &amp; Corporate Finance</b>	<b>-0.239</b>	Following an update on the Central Loan & Investment Account (CLIA), with continuing increased income from investments / reduced borrowing, we can report a favourable movement of £0.250m.
<b>Grand Total</b>	<b>-0.728</b>	

## Budget Monitoring Report

Service	Approved Budget (£m)	Projected Outturn (£m)	Annual Variance (£m)	Last Month Variance (£m)	In-year Moratorium (£m)	Cause of Major Variances greater than £0.050m	Action Required
<b>Social Services</b>							
<b>Older People</b>							
Localities	23.247	23.310	0.063	-0.075	-0.111	The Older People residential care budget is projecting and underspend of £0.063m, due to service demand net of client income from property recharges and expected reimbursements where we are waiting on decisions for deputyships and assets held in trust. Homecare is £0.224m overspent. Locality workforce and professional support budgets are underspent by £0.076m and day care is underspending by £0.022m.	
Minor Variances	11.633	11.549	-0.084	0.056	0.000		
<b>Adults of Working Age</b>					0.000		
Children to Adult Transition Services	1.001	0.799	-0.202	-0.168	0.000	This is the cost of care packages for young adults transferring from Childrens Services to Adult Social Care. Care packages are new this financial year and very often need to be estimated in the first instance, meaning costs can change throughout the year as service costs are finalised.	
Professional and Administrative Support	0.468	0.382	-0.086	-0.055	0.000	In-year vacancies are the cause of this underspend.	
Transition & Disability Services Team	0.818	0.764	-0.054	-0.034	0.000	There are vacancies within this service and recruitment is being delayed resulting in increased underspend.	
Residential Placements	2.607	2.921	0.314	0.335	0.000	This is the overall cost of care packages for people with mental ill health. This is a volatile service and additional service needs can be identified throughout the year leading to increased costs.	
Professional Support	0.859	0.801	-0.058	-0.049	-0.100	The underspend is due to in-year vacancies,	
Minor Variances	35.769	35.679	-0.090	-0.124	0.000		
<b>Children's Services</b>					0.000		
Family Group Meetings	0.126	0.198	0.072	0.061	-0.005	Demand for this service is resulting in increased sessional worker hours.	
Family Placement	3.175	2.953	-0.222	-0.203	0.000	The number of in-house foster carers is lower than those which we have historically had.	
Integrated Working	0.210	0.272	0.062	0.057	0.000	Pressures are due to contributions toward the Integrated Family Support Service and a shortfall in Supported People Funding	
Family Support	0.416	0.465	0.050	0.045	-0.020	Demand is high for this service which has resulted in additional sessional staff hours	
Legal & Third Party	0.262	0.597	0.336	0.280	0.000	Legal costs are overspent by £0.194m due to the number of cases going through the courts and some use of external legal professionals. Client support and Section 17 costs are overspent by £0.136m. Direct Payments are overspending by £0.006m due to demand.	
Residential Placements	1.669	1.326	-0.343	-0.348	0.000	Welsh Government grant The in-house residential care provision is in receipt of a significant Welsh Government Grant which is offsetting in-year costs	

## Budget Monitoring Report

Service	Approved Budget (£m)	Projected Outturn (£m)	Annual Variance (£m)	Last Month Variance (£m)	In-year Moratorium (£m)	Cause of Major Variances greater than £0.050m	Action Required
Professional Support	6.128	7.086	0.958	0.909	0.000	To support adequate levels of child protection, the established staffing structure needs to be at a sufficient level to meet mandatory safeguarding standards. Vacancies are minimised where possible and additional temporary posts are sometimes required to be able to meet the challenges and demands of Childrens Services. Two managed agency teams are currently being contracted to support the service reserves are being used to mitigate these costs as much as possible but there is a projected overspend of £0.610m as a result, these costs may increase if a requirement to extend these contracts further. The Leaving Care budget, which supports young people who are looked after children, is overspending £0.170m due to increasing numbers of care leavers which includes unaccompanied asylum seeking children. The costs for some external service contracts are £0.084m overspent due to inflationary pressures. Cost of Direct Payments to provide support to children with disabilities is £0.105m overspent due to service demand. Smaller variance across this service are £0.011m underspent.	
Minor Variances	0.361	0.373	0.013	0.013	0.000		
<b>Safeguarding &amp; Commissioning</b>					0.000		
Business Systems & Financial Assessments	0.988	1.078	0.089	0.089	-0.032	A new social services IT system is being implemented which requires additional project management and development costs.	
Charging Policy income	-3.385	-3.535	-0.150	-0.157	0.000	This is the income from service users who are charged a contribution towards the care they receive.	
Minor Variances	2.883	2.885	0.002	0.046	0.000		
<b>Total Social Services</b>	<b>89.235</b>	<b>89.905</b>	<b>0.670</b>	<b>0.678</b>	<b>-0.268</b>		
<b>Out of County Placements</b>							
Children's Services	12.281	13.619	1.338	1.107	0.000	The service is facing continued high demand for placements together with supply market challenges and inflationary pressures with 37 new placements made in the year to date and reduced contingency provision of £0.100m now as we approach the final quarter of the year.	
Education & Youth	5.004	5.192	0.188	0.230	0.000	The service is facing continued high demand for placements together with supply market challenges and inflationary pressures with 24 new placements made in the year to date and reduced contingency provision of £0.100m now as we approach the final quarter of the year.	
<b>Total Out of County Placements</b>	<b>17.285</b>	<b>18.811</b>	<b>1.526</b>	<b>1.337</b>	<b>0.000</b>		
<b>Education &amp; Youth (Non-Schools)</b>							
Inclusion & Progression	5.569	5.428	-0.142	-0.032	-0.110	Further in year savings have been identified within the ALN service and EAL/Travellers service. Previously committed expenditure of £50k to offset Primary School ALN Band C overspend has now been funded with the Local Authority Education Grant ALN Learner Recovery funding. A further £60k has been identified within the EAL/Traveller service from the 2022-23 £95k budget carry forward balance committed for Trauma Training. One course has been run to date at a cost of £35k. The service have decided not to run anymore courses in 2023-24, therefore releasing the balance of £60k as a saving.	
Integrated Youth Provision	0.959	0.853	-0.106	-0.085	-0.030	Savings from staff vacancies	

## Budget Monitoring Report

Service	Approved Budget (£m)	Projected Outturn (£m)	Annual Variance (£m)	Last Month Variance (£m)	In-year Moratorium (£m)	Cause of Major Variances greater than £0.050m	Action Required
School Improvement Systems	1.836	1.674	-0.163	-0.118	0.000	There has been a projected reduction in the Early Entitlement service, in payments to settings due to demography. Top up subsidy continuing and other Welsh Government grants, allowing core budget to be released within the Service. The School Improvement Service have reported an underspend relating to the Digital Advisor post. This role was not appointed to until September, 2023, therefore creating a saving. Other underspends relate to income from several grants around ACL to offset manager time. A further £0.034m has been identified within School Improvement from additional grants. £0.027m from the Shared Prosperity Fund Multiply project, £0.003m from the Citizens Curriculum grant and £0.004m for the secondment work to Estyn.	
Minor Variances	1.925	1.968	0.043	0.049	0.000		
<b>Total Education &amp; Youth (Non-Schools)</b>	<b>10.289</b>	<b>9.923</b>	<b>-0.367</b>	<b>-0.186</b>	<b>-0.140</b>		
<b>Schools</b>	<b>114.081</b>	<b>114.313</b>	<b>0.232</b>	<b>0.232</b>	0.000	Redundancy costs £0.290m over budget after taking account of reserves carried forward, Free School Meals price increase and take up totalling £0.126m, mitigated by (£0.100m) underspend in pension added years and a number of minor variances totalling (£0.084m) but each below (£0.025m).	
<b>Streetscene &amp; Transportation</b>							
Service Delivery	10.843	11.079	0.236	0.231	-0.077	Service Delivery have implemented tight controls to the allocation of PPE, materials and receptacles through the in-house stores. Changes to the security provision in the Alltami Depot, Greenfield transfer station and HRC sites have generated savings as per MTFs 2023/24, following a review of the service needs. Cleaning costs have also been reviewed and reduced. The service is subject to increasing inflationary pressures and demand for temporary repairs on the road network, largely due to a lack of funding and investment in the highway network and fluctuating costs of tar and traffic management for repairs. Any overall overspend, is partly offset by performance of the in-house construction team delivering work such as 20mph scheme rather than contracting the work externally.	
Highways Network	8.594	9.860	1.266	1.239	0.000	The renewal of the fleet contract through contract extension from October 2023 has realised an in-year overspend of £0.658m. A variance of £0.170m is attributable to cost increases for both road fuel and streetlighting energy, increased insurance premiums, and defective highway network infrastructure repairs. Additional costs of £1m are projected in relation to the clean up and reinstatement works required following Storm Babet and more recently Storm Ciaran. It is anticipated that some Emergency Financial Assistance Funding (EFAS) from WG can be claimed alongside utilisation of the Severe Weather Reserve, bringing the net cost down to a projected £0.500m.	Further increases on the Fleet Contract in 2024/25 are being considered within the MTFs.
Transportation	11.350	11.163	-0.187	-0.098	-0.169	Vacancies within Transport Strategy and moratorium on recruitment are contributing to the overall underspend.	

## Budget Monitoring Report

Service	Approved Budget (£m)	Projected Outturn (£m)	Annual Variance (£m)	Last Month Variance (£m)	In-year Moratorium (£m)	Cause of Major Variances greater than £0.050m	Action Required
Regulatory Services	11.440	11.592	0.152	0.225	-0.072	The overspend variance is due to sustained high volumes of residual waste being collected, together with the reduction in income levels for both recyclable materials and a reducing return on electricity generation from gas and solar at the former landfill sites. Positive impacts from the moratorium on spend at Month 8.	
Other Minor Variances	-0.000	-0.000	-0.000	0.000	0.000		
<b>Total Streetscene &amp; Transportation</b>	<b>42.227</b>	<b>43.694</b>	<b>1.467</b>	<b>1.597</b>	<b>-0.318</b>		
<b>Planning, Environment &amp; Economy</b>							
Development	0.138	-0.198	-0.336	-0.314	-0.021	Receipt of a one-off high value Planning Fee (£0.300m for Northern Gateway)	
Access	1.618	1.683	0.065	0.122	-0.047	Projected cost of Ash Die Back works projected to March, 2024 mitigated by savings from vacant posts and Countryside grant maximisation	
Climate Change	0.183	0.113	-0.070	-0.062	-0.007	Staff savings from vacant posts	
Regeneration	0.813	0.704	-0.109	-0.109	-0.020	Staff savings from vacant posts, Wales Rally GB budget saving, maximisation of grant income	
Management & Strategy	1.409	1.203	-0.206	-0.203	-0.004	Staff savings from vacant posts	
Minor Variances	3.396	3.374	-0.022	0.043	-0.082		
<b>Total Planning &amp; Environment</b>	<b>7.557</b>	<b>6.880</b>	<b>-0.678</b>	<b>-0.524</b>	<b>-0.181</b>		
<b>People &amp; Resources</b>							
HR & OD	2.419	2.315	-0.104	-0.087	-0.046	Staff savings from vacant posts	
Corporate Finance	2.277	2.186	-0.092	-0.067	-0.087	Staff savings from vacant posts, revised projection for Feasibility Studies	
<b>Total People &amp; Resources</b>	<b>4.697</b>	<b>4.501</b>	<b>-0.195</b>	<b>-0.154</b>	<b>-0.133</b>		
<b>Governance</b>							
Legal Services	0.992	1.197	0.205	0.206	0.000	Additional costs for locum services covering vacant posts	
Democratic Services	2.468	2.517	0.049	0.069	0.000	Backdated Superannuation costs and current level of Members Allowances	
Internal Audit	1.051	1.020	-0.031	-0.000	0.000	Reduced Postage costs projected	
ICT	5.328	5.255	-0.074	-0.051	-0.138	Estimated cost for packaged software application (Flare) lower than previously anticipated (£0.076m), delayed project savings £0.030m Moratorium, minor variances across the Service	
Customer Services	1.146	0.936	-0.210	-0.167	-0.060	Staff savings from previous vacancies, higher than previously anticipated fee income Registrars, commitment challenge across the Service contributing to the Moratorium	
Revenues	0.637	0.495	-0.142	-0.173	0.000	Projected surplus on the Council Tax Collection Fund £0.150m reduced at Month 7 due to potential exemptions following the recent storms	
Minor Variances	0.320	0.298	-0.022	-0.022	-0.005		
<b>Total Governance</b>	<b>11.943</b>	<b>11.718</b>	<b>-0.225</b>	<b>-0.139</b>	<b>-0.203</b>		
<b>Assets</b>							
CPM & Design Services	0.713	0.522	-0.191	-0.093	0.000	Due to increased fee income	
Minor Variances	10.428	10.295	-0.133	-0.116	-0.020		
<b>Total Assets</b>	<b>11.141</b>	<b>10.817</b>	<b>-0.324</b>	<b>-0.210</b>	<b>-0.020</b>		



## Budget Monitoring Report

Service	Approved Budget (£m)	Projected Outturn (£m)	Annual Variance (£m)	Last Month Variance (£m)	In-year Moratorium (£m)	Cause of Major Variances greater than £0.050m	Action Required
<b>Housing and Community</b>							
Housing Solutions	2.334	5.054	2.719	2.649	0.000	The Housing Solutions service is currently reflecting a net projected overspend of £2.719m. This is mainly due to a projected overspend of £3.632m on temporary accommodation within Hotels and B and B provision, which is being offset by additional Housing Benefit income of (£0.447m). There are also other projected underspends and mitigation impacts within the wider Housing Solutions service amounting to a net figure of £0.466m, including additional internal allocation of HSG to fund salary costs, use of reserves, minor salary savings due to vacancies and use of WG grant income. The service are actively implementing a number of mitigation measures, some of which may have operational impacts on other parts of the wider Housing service, which will be incorporated within an action plan to reduce the current level of projected overspend within the Homelessness service.	
Minor Variances	13.656	13.660	0.005	0.024	-0.030		
<b>Total Housing and Community</b>	<b>15.990</b>	<b>18.714</b>	<b>2.724</b>	<b>2.673</b>	<b>-0.030</b>		
<b>Chief Executive's</b>	<b>1.672</b>	<b>1.667</b>	<b>-0.005</b>	<b>0.009</b>	<b>0.000</b>		
<b>Central &amp; Corporate Finance</b>	<b>26.003</b>	<b>24.120</b>	<b>-1.882</b>	<b>-1.644</b>		The projection on the Central Loans and Investment Account (CLIA) was reported as an underspend of (£1.550m) due to the Council having not taken out any new short or long term borrowing and continues to invest a significant amount of funds. This pattern has continued from the previous financial year resulting in no short term borrowing costs being incurred and the Council generating increased income from investments, which have increased in line with bank interest rates. The favourable variance increased further following the benefit of a £0.048m NDR windfall at Month 6. The variance has improved further following a review of the CLIA forecast underspend, with an improvement of £0.100m in October. At Month 8 following an update on the CLIA forecast, with continuing increased income from investments/reduced borrowing, there has been a further favourable movement of £0.250m.	
<b>Grand Total</b>	<b>352.121</b>	<b>355.063</b>	<b>2.942</b>	<b>3.671</b>	<b>-1.293</b>		

Mae'r dudalen hon yn wag yn bwrpasol

2023/24 Efficiencies Outturn Tracker - Month 8

Efficiency Description	Accountable Officer	Efficiency Target	Projected Efficiency	(Under)/Over Achievement	Efficiency Open/Closed (O/C)	Reason for variation	Mitigating Action if Amber or Red
		2023/24 £m	2023/24 £m	2023/24 £m			
<b>Portfolio</b>							
<b>Corporate</b>							
Reduction In CLIA	Chris Taylor	0.364	0.364	0.000	C		
Actuarial Review	Gary Ferguson	1.874	1.874	(0.000)	C		
NI Reversal	Rachel Parry Jones	0.474	0.474	0.000	C		
<b>Total Corporate Services</b>		<b>2.712</b>	<b>2.712</b>	<b>(0.000)</b>			
<b>Chief Executives / Assets</b>							
Transport Savings	Neal Cockerton	0.010	0.010	0.000	C		
Vacancy Savings	Neal Cockerton	0.048	0.048	0.000	C		
3rd Sector Budget	Neal Cockerton	0.041	0.041	0.000			
<b>Total Chief Executives</b>		<b>0.099</b>	<b>0.099</b>	<b>0.000</b>			
<b>People &amp; Resources</b>							
Modern Apprentices HR&OD	Sharon Carney	0.072	0.072	0.000	C		
Vacancy Savings Corporate Finance	Gary Ferguson	0.086	0.086	0.000	C		
Transport and Training Savings Corporate Finance	Gary Ferguson	0.016	0.016	0.000	C		
<b>Total People &amp; Resources</b>		<b>0.174</b>	<b>0.174</b>	<b>0.000</b>			
<b>Assets - ADMs</b>							
Newydd	Rachael Corbelli	0.019	0.019	0.000	C		
Newydd NI	Rachael Corbelli	0.023	0.023	0.000	C		
<b>Total Assets - ADMs</b>		<b>0.042</b>	<b>0.042</b>	<b>0.000</b>			
<b>Housing &amp; Communities</b>							
CTRS Reduction	Vicky Clark	0.147	0.147	0.000	C		
<b>Total Housing &amp; Communities</b>		<b>0.147</b>	<b>0.147</b>	<b>0.000</b>			
<b>Governance</b>							
Members Support Budget	Gareth Owen	0.016	0.016	0.000	C		
Members Allowances	Gareth Owen	0.060	0.060	0.000	C		
Central Despatch	Gareth Owen	0.022	0.022	0.000	C		
Mold & Buckley Connects	Gareth Owen	0.060	0.060	0.000	C		
<b>Total Governance</b>		<b>0.158</b>	<b>0.158</b>	<b>0.000</b>			
<b>Planning, Environment &amp; Economy</b>							
Vacancy Savings	Andrew Farrow	0.020	0.020	0.000	C		
Fee Income	Andrew Farrow	0.180	0.180	0.000	C		
<b>Total Planning, Environment &amp; Economy</b>		<b>0.200</b>	<b>0.200</b>	<b>0.000</b>			
<b>Streetscene &amp; Transportation</b>							
Enhanced Enforcement for Recycling	Katie Wilby	0.046	0.046	0.000	O	Side waste enforcement is already taking place with FPNs being issued, but the next steps for enforcing against those who do not habitually recycle will be to take enforcement action if residents place recyclable waste in their black bin. To introduce this will first require a period of education and engagement. Additional x3 recycling officers are currently being recruited and, once appointed, the aim is for these officers to support with door-knocking campaigns and community events in advance of introducing enhanced enforcement	Likely introduction is January 2024.
Part night Street Lighting	Katie Wilby	0.018	0.000	(0.018)	O	Difficult to implement in year due to the consultation required, and the limited opportunity following previous roll-outs. This will also require investment in the equipment to allow the switch-offs	Discussions being held with an update to come how we can achieve this saving.
Review Provision of Public Conveniences	Katie Wilby	0.012	0.000	(0.012)	O	The efficiency is largely reliant on the review of sites following the implementation of the Local Toilet Strategy and capital investment in FY 24/25-26/27.	
Extend, Repair & Reuse Initiatives	Katie Wilby	0.010	0.000	(0.010)	O	When this was put forward, we stated that the initiative would be dependent on investment funding either from WG Circular Economy grant funding or capital programme. We are still awaiting the outcome of our bid to WG, which is now unlikely given the current economic climate. Without the grant funding the initiative cannot be introduced and the efficiency will not be met.	
Waste & Recycling Round Review	Katie Wilby	0.075	0.075	0.000	C		
In House Highways Service	Katie Wilby	0.025	0.025	0.000	C		
Review of Security Arrangements Alltami Depot	Katie Wilby	0.050	0.050	0.000	C		
Apprenticeship Trainee Scheme Reduction	Katie Wilby	0.035	0.035	0.000	C		

Tudalen 283

Tudalen 284

Efficiency Description	Accountable Officer	Efficiency Target	Projected Efficiency	(Under)/Over Achievement	Efficiency Open/Closed (O/C)	Reason for variation	Mitigating Action if Amber or Red	
		2023/24 £m	2023/24 £m	2023/24 £m				
<b>Portfolio</b>								
Increase Car Parking Charges	Income Generation	Katie Wilby	0.187	0.187	0.000	C	Decision approved and new charges will come into effect from October 2023 (original date planned was July 2023). Additional initiatives e.g. Free after Three and extension to parking times will mean that the original efficiency will be difficult to achieve unless the utilisation levels increase beyond current levels. Delays in being implemented.	
Introduce Car Parking Charges on all Council Owned Car Parks	Income Generation	Katie Wilby	0.035	0.000	(0.035)	O		
Fleet Workshop	Income Generation	Katie Wilby	0.010	0.010	0.000	C		
Training Facility	Income Generation	Katie Wilby	0.010	0.010	0.000	C		
Funeral Services	Income Generation	Katie Wilby	0.010	0.010	0.000	C		
<b>Total Streetscene &amp; Transportation</b>			<b>0.523</b>	<b>0.448</b>	<b>(0.075)</b>			
<b>Social Services</b>								
Contribution to Regional Team	Reduction in Contribution	Neil Ayling	0.050	0.050	0.000	C		
Reduced Contribution to EDT	Contract Costs Reduced	Neil Ayling	0.011	0.011	0.000	C		
Retendering of HFT	Contract Costs Reduced	Neil Ayling	0.040	0.040	0.000	C		
<b>Total Social Services</b>			<b>0.101</b>	<b>0.101</b>	<b>0.000</b>			
<b>Education &amp; Youth</b>								
Central Management Budget	Schools Buildings Insurance / Temp	Claire Homard	0.060	0.060	0.000	O		
ALN Advocacy	Offset costs from LAEG ALN Grant	Claire Homard	0.020	0.020	0.000	O		
ALN Legal	Offset costs from LAEG ALN Grant	Claire Homard	0.010	0.010	0.000	O		
ALN Resource Provisions	Offset costs from LAEG ALN Grant	Claire Homard	0.100	0.100	0.000	O		
Early Years Entitlement	Budget Reductions	Claire Homard	0.095	0.095	0.000	O		
Youth Club Buildings	Building Closure	Claire Homard	0.017	0.017	0.000	O		
Youth Services	Vacant Posts (1 FTE 1 PT)	Claire Homard	0.056	0.056	0.000	O		
Youth Justice	Offset costs from Grant	Claire Homard	0.016	0.016	0.000	O		
<b>Total Education &amp; Youth</b>			<b>0.374</b>	<b>0.374</b>	<b>0.000</b>			
<b>Schools</b>								
3% Reduction in Delegated Funding		Claire Homard	3.103	3.103	0.000	O		
NI Reversal (Schools & Teachers)		Claire Homard	0.857	0.857	0.000	O		
Actuarial Review		Claire Homard	0.776	0.776	0.000	O		
<b>Total Schools</b>			<b>4.736</b>	<b>4.736</b>	<b>0.000</b>			
<b>Total 2023/24 Budget Efficiencies</b>			<b>9.265</b>	<b>9.190</b>	<b>(0.075)</b>			

	%	£
<b>Total 2023/24 Budget Efficiencies</b>	<b>100</b>	<b>9.265</b>
<b>Total Projected 2023/24 Budget Efficiencies Underachieved</b>	<b>-1</b>	<b>(0.075)</b>
<b>Total Projected 2023/24 Budget Efficiencies Achieved</b>	<b>99</b>	<b>9.190</b>
<b>Total 2023/24 Budget Efficiencies (Less Previously agreed Decisions)</b>		
<b>Total Projected 2023/24 Budget Efficiencies Underachieved</b>	<b>100</b>	<b>0.000</b>
<b>Total Projected 2023/24 Budget Efficiencies Achieved</b>	<b>0</b>	<b>0.000</b>

**Movements on Council Fund Unearmarked Reserves**

	£m	£m
Total Reserves as at 1 April 2023	19.162	
Less - Base Level	(5.769)	
<b>Total Reserves above base level available for delegation to Cabinet</b>		13.393
Less - COVID-19 Hardship Funding Allocation		3.743
Less - Children's Services Legal Costs		0.142
Add - Transfer to Reserve Budget 2023/24		0.006
Less - Clwyd Theatr Cymru (Month 2)		0.100
Less - actual impact of the pay award		2.702
Add - Total Balances Released to Reserves (Month 5)		0.648
Add - Council Tax Balance Released to Reserves (Month 7)		0.500
Less - Month 8 projected outturn		2.942
<b>Total Contingency Reserve available for use</b>		<b>4.918</b>

Brought Forward 9.508

Mae'r dudalen hon yn wag yn bwrpasol

**Budget Monitoring Report**  
**Housing Revenue Account Variances**

**MONTH 8 - SUMMARY**

Service	Revised Budget (£m)	Projected Outturn (£m)	Variance (£m)	Last Month Variance (£m)	Cause of Major Variance	Action Required
<b>Housing Revenue Account</b>						
Income	(38.829)	(38.688)	0.141	0.206	There is a net pressure relating to void properties of £0.251m. This relates to costs such as void rent loss, council tax charges and service charges and is net of additional income relating to new build properties and voids moving to target rent. We are anticipating a variance of approximately £0.024m on garage rents. We are forecasting a reduction in the requirement to top up the Bad Debt Provision of (£0.125m) which includes (£0.075m) at Month 8. Other minor variances of (£0.009m).	
Capital Financing - Loan Charges	7.010	7.010				
Estate Management	3.125	2.880	(0.245)	(0.260)	Projected vacancy savings of approximately (£0.304m) which is being offset by agency costs of £0.191m. Additional allocation of Housing Support Grant (£0.100m). Other minor variances of (£0.032m).	
Landlord Service Costs	1.617	1.479	(0.137)	(0.111)	Projected vacancy savings of approximately (£0.160m). We are also forecasting an increase in fleet costs of £0.033m and materials and hire of £0.045m. There is an anticipated reduction in subcontractor spend of (£0.032m). Other minor variances of (£0.023m).	
Repairs & Maintenance	12.150	12.406	0.255	0.045	Projected vacancy savings of approximately (£0.160m) . Increased Fleet Contract renewal costs of £0.126m. Anticipated increase of Sub Contractor costs of £0.250m relating to voids. Other minor variances of £0.039m.	
Management & Support Services	2.678	2.683	0.005	0.019	Projected vacancy savings of approximately (£0.061m). Insurance Costs £0.034m. Support Service savings of (£0.024m). Other minor variances of £0.059m.	
Capital Expenditure From Revenue (CERA)	12.712	12.712				
HRA Projects	0.126	0.126	(0.000)	0.000		
Contribution To / (From) Reserves	(0.589)	(0.589)				
<b>Total Housing Revenue Account</b>	<b>(0.000)</b>	<b>0.018</b>	<b>0.018</b>	<b>(0.100)</b>		

Mae'r dudalen hon yn wag yn bwrpasol



# Eitem ar gyfer y Rhaglen 9



## CABINET

<b>Date of Meeting</b>	Tuesday, 16 <sup>th</sup> January 2024
<b>Report Subject</b>	Council Tax Reform – Welsh Government Phase 2 Consultation
<b>Cabinet Member</b>	Cabinet Member for Finance, Inclusion, Resilient Communities including Social Value and Procurement
<b>Report Author</b>	Chief Officer (Governance)
<b>Type of Report</b>	Operational

## EXECUTIVE SUMMARY

This report provides Cabinet members with information on a phase 2 Welsh Government consultation seeking views on the ongoing council tax reform programme. The phase 2 proposals centre on:

- The scale and pace of potential council tax banding/revaluation reforms
- Reform of the Class F council tax exemption for properties which are unoccupied where the previous occupier has died, and no grant of probate or letters of administration have been made.
- Clarity over the appropriate terminology and criteria for the Class U council tax exemption for households where the occupier is certified as being 'severely mentally impaired'.

## RECOMMENDATIONS

1	Cabinet is asked to consider the Welsh Government (phase 2) proposals to reform Council Tax and authorise senior officers to respond to the consultation, as set out in appendix 1 to this report.
---	--

## REPORT DETAILS

<b>1.00</b>	<b>EXPLAINING THE (PHASE 2) COUNCIL TAX REFORM PROPOSALS</b>																																												
1.01	<p>In September 2022, Welsh Government (WG) carried out a phase 1 consultation on proposals to reform council tax. The proposals include:</p> <ul style="list-style-type: none"> <li>• Completing a council tax revaluation</li> <li>• Designing a new system of tax bands and rates that is more progressive.</li> <li>• Improving the framework of discounts, disregarded persons, exemptions, and premiums</li> <li>• Improving the Council Tax Reduction scheme.</li> </ul>																																												
1.02	<p>WG now propose to complete a council tax revaluation of all 1.5m domestic properties in Wales to rebalance the tax system to reflect latest property values, especially since the last revaluation exercise was undertaken in 2003. WG also consider the current system needs major reform as the council tax places a higher tax burden, proportionately, on those with lower levels of wealth.</p>																																												
1.03	<p>Welsh Government intends the reforms to be revenue-neutral, not a revenue-raising exercise, but as with any revaluation exercise, not everyone would remain the same property band, and there would be households who are winners or losers, notwithstanding others could remain in the same band.</p> <p>At a local authority level, there would also be winners and losers too as any changes in the overall tax base levels would need to be reviewed through compensatory and adjusted changes in the re-distribution of Revenue Support Grant to ensure each local authority still has sufficient overall income to fund local services.</p>																																												
1.04	<p>The phase 2 consultation proposals set out three options for change, and which also set out the scale of each option, and how quickly they could be implemented. For ease of reference, the approaches are defined as ‘minimal’, ‘modest’, or ‘expanded’ versions of reform.</p>																																												
1.05	<p>As local context, to the proposed changes, the table below shows the current distribution of council tax properties in Flintshire by band.</p> <table border="1"> <thead> <tr> <th>Band</th> <th>A</th> <th>B</th> <th>C</th> <th>D</th> <th>E</th> <th>F</th> <th>G</th> <th>H</th> <th>I</th> <th>Total</th> </tr> </thead> <tbody> <tr> <td>Ratio</td> <td>6/9</td> <td>7/9</td> <td>8/9</td> <td>9/9</td> <td>11/9</td> <td>13/9</td> <td>15/9</td> <td>18/9</td> <td>21/9</td> <td></td> </tr> <tr> <td>Num Props.</td> <td>4,496</td> <td>9,608</td> <td>20,891</td> <td>13,308</td> <td>11,074</td> <td>7,789</td> <td>3,220</td> <td>595</td> <td>221</td> <td>71,202</td> </tr> <tr> <td>% of Props.</td> <td>6.3</td> <td>13.5</td> <td>29.3</td> <td>18.7</td> <td>15.6</td> <td>10.9</td> <td>4.5</td> <td>0.8</td> <td>0.3</td> <td></td> </tr> </tbody> </table>	Band	A	B	C	D	E	F	G	H	I	Total	Ratio	6/9	7/9	8/9	9/9	11/9	13/9	15/9	18/9	21/9		Num Props.	4,496	9,608	20,891	13,308	11,074	7,789	3,220	595	221	71,202	% of Props.	6.3	13.5	29.3	18.7	15.6	10.9	4.5	0.8	0.3	
Band	A	B	C	D	E	F	G	H	I	Total																																			
Ratio	6/9	7/9	8/9	9/9	11/9	13/9	15/9	18/9	21/9																																				
Num Props.	4,496	9,608	20,891	13,308	11,074	7,789	3,220	595	221	71,202																																			
% of Props.	6.3	13.5	29.3	18.7	15.6	10.9	4.5	0.8	0.3																																				

In summary, 49.1% of all domestic properties are currently in the lower bands (A to C), 18.7% are in the average Band D, and 32.1% are in the upper bands (E to I).

1.06 For the council tax revaluation reforms classed as ‘**minimal**’ reforms, a council tax revaluation may take place based on the retention of the current nine band property system (bands A to I) and using existing charging ratios.

This would ensure properties are revalued to reflect latest market values with revised property value thresholds applied across the existing nine bands, but with no changes to the banding charge ratios. As this approach is seen as the easiest reform to introduce, the earliest opportunity to revalue all domestic properties could be implemented from April 2025.

This option would bring property values up to date, but as with any revaluation exercise, some properties would be subject to a banding reduction, some will stay the same, and others will see a banding increases.

Undertaking a full revaluation could still be seen as progressive reform, and a step in the right direction to longer term reforms, especially as England and Scotland have not undertaken a similar exercise since the introduction of the council tax system thirty years ago.

Also, as in the previous revaluation exercise of 2005, a transitional relief scheme would be expected to be introduced to cushion the impact for those whose bills increase due to their property value moving upwards by more than one band.

The proposed changes to the banding thresholds using the existing nine tier banding system would be along the lines of:

#### Current

#### Proposed ‘minimal’ reforms

Band	Value threshold	Band	Value threshold
A	Up to £44,000	A	Up to £112,000
B	£65,000	B	£155,000
C	£91,000	C	£211,000
D	£123,000	D	£278,000
E	£162,000	E	£376,000
F	£223,000	F	£516,000
G	£324,000	G	£748,000
H	£424,000	H	£987,000
I	over £424,000	I	over £987,000

The Institute of Fiscal Studies have been commissioned by Welsh Government to undertake quantitative modelling of the potential impact of any revaluation. The IFS confirm the data is purely for illustrative purposes and could change prior to any implementation of any revaluation exercise, because the Valuation Office Agency is continuing to refine its estimates of April 2023 property value.

In terms of the ‘minimal’ reforms, the IFS research indicates the Council Tax Base in Flintshire would reduce and Revenue Support Grant would increase to take account of the redistribution of grant funding for areas where changes in property values since the last revaluation are comparatively lower than the average.

In other words, what we would lose in the Tax Base and with overall Council Tax income would be compensated through additional RSG.

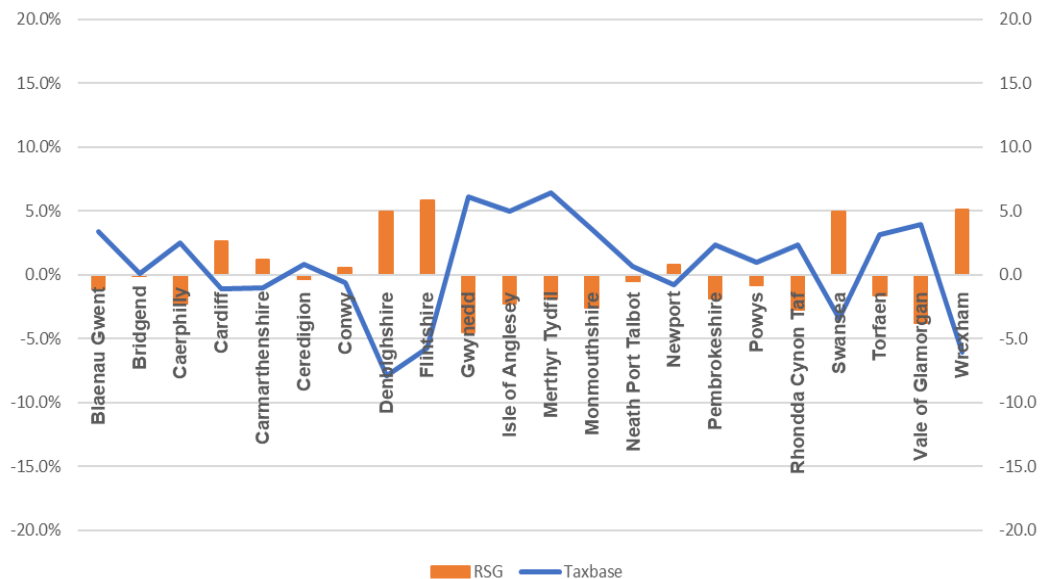

1.07

For the ‘modest’ reforms, a council tax revaluation would continue to take place based on the retention of the nine-band property system but with changes to the banding ratios. The banding ratios for A to C bands would be lowered, Band D would stay the same, and Bands E to I would be subject to higher tax rates.

This option presents a slight move towards increased fairness in the system but would result in winners and losers as some households would pay less, some would stay the same, and some would be expected to pay more, even if households remained in the same band following revaluation.

However, it is important to consider that as nearly 23,000 of domestic properties in the County are currently placed in the upper bands (E to I), the modest reforms would increase the banding ratios/tax rates for many households.

**Current**

**Proposed 'modest' reforms**

Band	Value threshold	Tax Rate	Band	Value threshold	Tax Rate
A	Up to £44,000	6 / 9	A	Up to £112,000	5 / 9
B	£65,000	7 / 9	B	£155,000	6 / 9
C	£91,000	8 / 9	C	£211,000	7.5 / 9
D	£123,000	9 / 9	D	£278,000	9 / 9
E	£162,000	11 / 9	E	£376,000	12 / 9
F	£223,000	13 / 9	F	£516,000	15 / 9
G	£324,000	15 / 9	G	£748,000	18 / 9
H	£424,000	18 / 9	H	£987,000	22 / 9
I	over £424,000	21 / 9	I	over £987,000	27 / 9

Modelling undertaken by the IFS, indicates the impact of the 'modest' reforms would continue to represent an overall reduction in the Flintshire Council Tax Base, with a higher proportion of RSG to compensate for reduced levels of Council Tax.

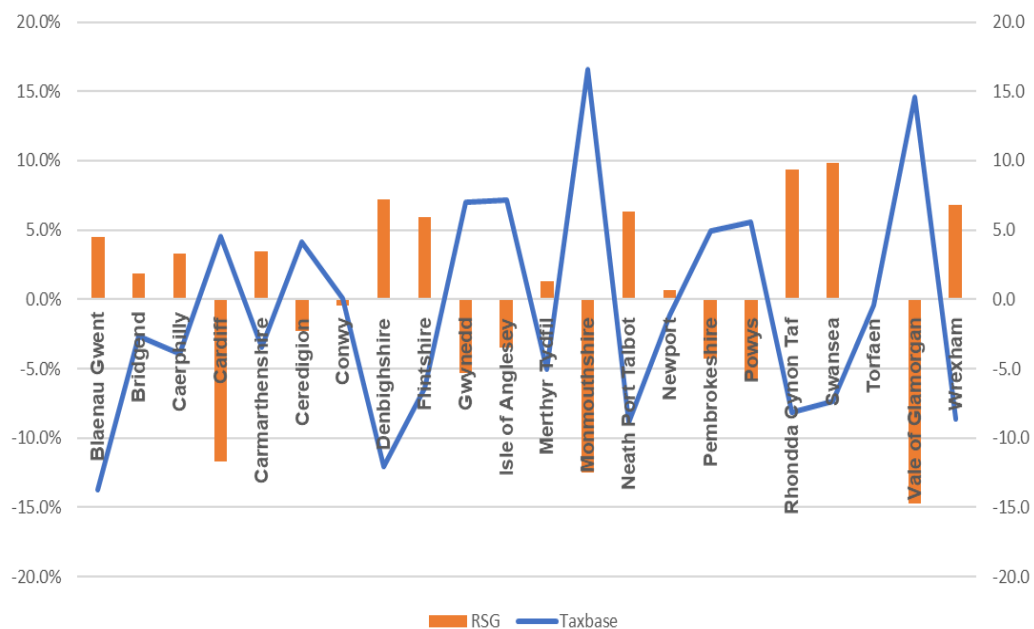

1.08

For the **'expanded'** reforms, a council tax revaluation could take place based on a revised twelve-band property system. In other words, one lower band would be added below the current Band A, and two above the current highest Band I.

This approach would be seen as the most progressive, but with it, the biggest impact on households subject to council tax. It would add additional bands to the current structure (from 9 to 12) and redraw the band widths. The changes in tax rates would result in those in the lowest bands paying much less, and those in the upper bands paying more – and in some cases, considerably more. This option is perceived to make a significant step towards fairness within the tax system.

A1	up to £80,000
A2	£80k - £110k
B	£110k - £150k
C	£150k - £200k
D	£200k - £270k
E	£270k - £360k
F	£360k - £480k
G	£480k - £650k
H	£650k - £880k
I	£880k - £1.2m
J	£1.2m - £1.6m
K	over £1.6m

Whilst this approach is seen as the most progressive, the IFS predict more regional variations in terms of the likely changes to the tax base and RSG.

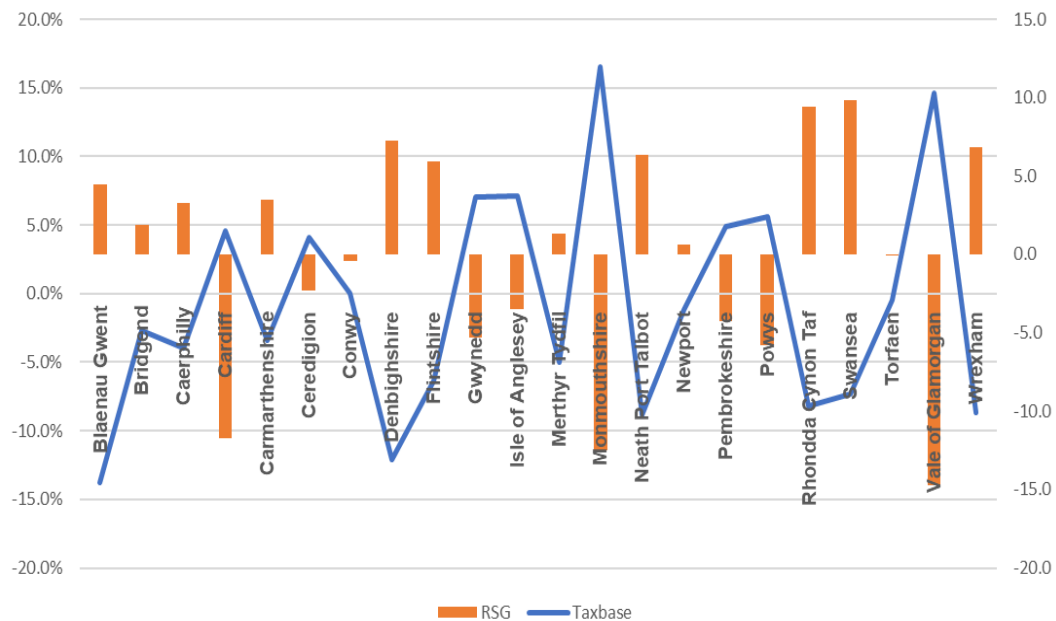

1.09 WG is also seeking views on three options for the pace of reform.

**Option 1 – April 2025**

This is the fastest pace of change. This is the original date the Valuation Office Agency has been working towards as part of the national revaluation of domestic properties.

All those households who would benefit from any reform would see it reflected in revised council tax bills from this date, although as in the previous revaluation exercise, a transitional relief scheme would cushion the impact on those whose property moves upwards by more than one band.

	<p>It is predicted on a national scale the impacts could be anything from 320,000 properties under minimal reforms to 700,000 under the expanded reforms.</p> <p><b>Option 2 – Defer until 2028</b></p> <p>This option suggests the deferral of any changes to the system until the next Senedd term, with 2028 being the earliest implementation date. This option means that no changes will take place to bands or bills, for a period of at least 4 years.</p> <p><b>Option 3 – incremental approach</b></p> <p>This option would allow any decided approach (minimal or modest) to be implemented from April 2025 and larger scale reform, such as the expanded approach could take place later, sometime in the next Senedd term.</p> <p>This option allows for change to be managed over a longer period and for the effects of change, to be effectively managed and measured.</p>
1.10	<p>In other reforms outlined in the phase 2 consultation paper, Class F exemptions apply to unoccupied properties where probate or letters of administration have not yet been granted.</p> <p>Behind each case, there is usually a bereaved family trying to organise the affairs of a family member who has died. The exemption applies for up to 6 months <b>after</b> probate is granted, but prior to this, there is no time limit on the period in which the exemption can be applied. This can result in some properties remaining exempt from council tax for very lengthy periods, or for an indefinite period.</p> <p>The number of Class F exemptions will vary from time to time, but there are currently a total of 360 domestic properties in the County that have been unoccupied since the former resident's death, where the only person liable for council tax would be the deceased's personal representative, and where probate or letters of administration have not yet been granted.</p> <p>In most cases, probate or letters of administration are granted quickly and the average timeline, across England and Wales, from submission to grant is 14 weeks.</p> <p>After probate has been awarded, the beneficiaries of the estate, or other family members, usually re-occupy the property or take steps to dispose of the property before it is re-occupied by the new owners.</p> <p>However, in a small number of cases, the Class F council tax exemption can last for extended periods. For example, there are currently 17 properties that have been exempt for periods more than 3 years, and in 3 cases, council tax exemptions have been in place for periods more than 10 years.</p> <p>Welsh Government are now looking to reform the Class F exemption by introducing a time-limit for this exemption. It is proposed that once a maximum time-period is exceeded, the property would become liable for</p>

	<p>council tax and the tax to be paid would be applied to the deceased's estate by the executor for the property.</p> <p>The aim of imposing a time limit is seen to act as an incentive for probate to be applied and executed within a reasonable timescale to stop properties being left empty and unoccupied for very lengthy periods. This change could be effective from 1 April 2026.</p>
1.11	<p>In other proposed changes, the Class U exemption applies to anyone who is certified as being 'severely mentally impaired' within the meaning of the legislation.</p> <p>Welsh Government consider the terminology used to describe the exemption is outdated, and the term is now inappropriate. There are no proposals to remove the exemption or to make it a time limited exemption, but reform proposals consider the benefits of changing the title of the exemption to "significant brain impairment" or 'significant brain condition' as it would better align with the social model of disability.</p> <p>Currently a person must be entitled to a qualifying benefit and provide medical certification to receive the exemption. The consultation proposes removing the qualifying benefit requirement condition. This change could be effective from 1 April 2026.</p>

<b>2.00</b>	<b>RESOURCE IMPLICATIONS</b>
2.01	<p>Local authorities in Wales would see changes in their local tax-bases and changes in revenue in each area if Welsh Government undertake the national revaluation as set out in any of the three proposals. In other words, the 'minimal', 'modest' and 'expanded' reforms would each have a redistributive impact on the Revenue Support Grant (RSG) which is allocated to each local authority using the complex funding formula.</p>
2.02	<p>Following a national revaluation, if a local authority tax-base decreases it would receive proportionately more in RSG to compensate for lower council tax revenue. On the other hand, if the tax base increased it would result in less RSG.</p> <p>The possible approaches presented would all change the amount of revenue which can be raised in each council area, and this would have a redistributed effect on the RSG allocations.</p>
2.03	<p>The RSG is allocated using a detailed formula which takes account of local ability to raise financial resources, so that grant funding is fair across Wales.</p>
2.04	<p>While there would inevitably be wide ranging effects on the tax-bases across Wales because of any revaluation, WG also advise there should be no significant overall changes in funding for council services.</p>
2.05	<p>The national revaluation of council tax bandings would be an extensive exercise and resourced through the Valuation Office Agency, though the effects of the revaluation would result in additional workloads within the</p>



	Revenues, particularly to administer any transitional rate relief scheme, deal with increased levels of customer enquiries, and provide advice and support to residents, particularly those who may struggle to pay increased levels of council tax in cases where properties are re-banded upwards.
2.06	Proposed changes to Class F and Class U exemptions would result in minimal additional workloads. The time limitations for Class F would inevitably result in the collection of increased council tax levels for the small number of cases where probate is not awarded within the agreed time periods. The Class F proposals would also prevent some properties from being left empty for long periods and encourage executors/next-of-kin not to delay applying for probate or letters of administration.

<b>3.00</b>	<b>IMPACT ASSESSMENT AND RISK MANAGEMENT</b>
3.01	WG is considering embarking on a national revaluation exercise with all three options to address the perceived unfairness in the current system and to bring property bands up-to-date and to ensure households are paying council tax at the correct rate, proportionate to their property values.
3.02	As with any revaluation, including the last exercise in 2005 (using property data from 2003), there will be a significant number of winners and losers. Those who are expected to pay more, and who move up by more than one property band would be expected to be eligible for transitional rate relief to cushion the financial impact over a longer period.
3.03	At a national level, the purpose of a national revaluation is not to raise additional income overall from council tax, but to redistribute the overall tax-take more fairly and evenly, considering any changes in the tax-bases for each local authority.
3.04	Based on latest research and modelling work commissioned by WG, irrespective of whether the 'minimal', 'modest', or 'expanded' versions of revaluation reform are used, the Institute for Fiscal Studies (IFS) is predicting the tax base in Flintshire for a 2023 revaluation could result in a drop in the overall tax base due to some regions across Wales seeing bigger increases in property values than other parts of Wales, particularly North East Wales, where there has been much slower growth.

<b>4.00</b>	<b>CONSULTATIONS REQUIRED/CARRIED OUT</b>
4.01	The phase 2 WG consultation follows on from a previous consultation in September 2022 and builds on the commitment of Welsh Government to create what they believe to be a fairer and more progressive council tax system.
4.02	The phase 2 consultation is open until 6 February and the purpose of this report is to provide cabinet with the opportunity to comment on the consultation proposals and to endorse the responses as prepared by the senior officer in the Revenues service.

4.03	The implementation date for any changes, including the national revaluation of domestic properties subject to council tax, could take effect from April 2025. Other changes relating to the reform of Class F and Class U exemptions would be effective from April 2026.
------	--

<b>5.00</b>	<b>APPENDICES</b>
5.01	Appendix 1 to this report sets out the recommended responses to the key questions within the consultation paper.

<b>6.00</b>	<b>LIST OF ACCESSIBLE BACKGROUND DOCUMENTS</b>
6.01	<p>Welsh Government Phase 2 Consultation on a Fairer Council Tax:</p> <p><a href="https://www.gov.wales/consultation-fairer-council-tax-phase-2-html">https://www.gov.wales/consultation-fairer-council-tax-phase-2-html</a></p> <p>Institute for Fiscal Studies – Assessing the Welsh Government’s consultation on reforms to council tax:</p> <p><a href="https://ifs.org.uk/publications/assessing-welsh-governments-consultation-reforms-council-tax">https://ifs.org.uk/publications/assessing-welsh-governments-consultation-reforms-council-tax</a></p>

<b>7.00</b>	<b>CONTACT OFFICER DETAILS</b>
7.01	<p><b>Contact Officer:</b> David Barnes, Revenues &amp; Procurement Manager  <b>Telephone:</b> 01352 703652  <b>E-mail:</b> <a href="mailto:david.barnes@flintshire.gov.uk">david.barnes@flintshire.gov.uk</a></p>

<b>8.00</b>	<b>GLOSSARY OF TERMS</b>
8.01	<p><b>Council Tax Bands</b> are set by the government’s independent Valuation Office Agency, not by the Council. The bands are currently based on what a domestic property might have been sold for in April 2003, not on today’s prices. The VOA takes account of the size, age, character and locality of property using sales data around the valuation date to arrive at the correct valuation band for each property.</p> <p><b>Council Tax Base:</b> is a measure of the Councils ‘taxable capacity’ considering the number of domestic properties subject to council tax (in the relevant property bands and ratios and then re-calculated at equivalent band D’s). The Council Tax Base also considers the number of properties subject to council tax after factoring in statutory discounts, discounts, and exemptions.</p>

**Progressive** - A progressive tax is a tax rate that increases as taxable income increases. It imposes a lower tax rate on low-income earners and a higher tax rate on those with a higher income.

**Revenue Support Grant:** is paid to each Council to cover the cost of providing standard services less the council tax income at the standard level. RSG also considers the level of the Council Tax Base. The Revenue Support Grant is allocated to each local authority using a detailed and complex formula which takes account of local ability to raise financial resources.

Mae'r dudalen hon yn wag yn bwrpasol

## Appendix 1 – Responses to the Welsh Government (Phase 2) Consultation on Council Tax Reforms

The Welsh Government has shown 3 possible approaches for how to design a fairer Council Tax system. We want to ask you about your appetite for reform. Do you think WG should aim for:

- approach 1: minimal reform
- approach 2: modest reform
- approach 3: expanded reforms
- or do you have other views or ideas about the approach WG should take to the scale of reform

We fully support the proposition of a national revaluation and believe council tax reforms should be implemented in phases, adopting a steady approach, and working towards a more progressive tax system.

For this reason, we believe approach 1 (minimal reform) should be implemented without delay from April 2025 and then implementation of approach 3 (expanded reforms) during the next Senedd term.

The property market has changed so much since 2003 and it is difficult for residents to align their property band based on a system of valuation thresholds that are not a reflection of modern-day house prices.

A timely revaluation exercise will help to address the regional disparities in house prices and reflect council tax banding that take account of slower levels of growth in property values in Flintshire compared to the national average.

The Council recognises the fragile position of local government finance across Wales and minimal reform implementation in 2025 should have smaller impacts across income distribution overall, both for individual households and the overall finances of each local authority finances.

Although a stepped approach to council tax revaluation reform is sensible by starting with approach 1 in 2025, we believe the system needs to be more progressive by subsequent implementation of approach 3 (the expanded reforms) at the earliest opportunity in the next Senedd term.

The Welsh Government has described when the changes could be made to the Council Tax bands and tax-rates. Do you think WG should make changes according to the:

- fastest timetable: minimal, modest or expanded reform by 1 April 2025
- slower reform: minimal modest or expanded reform starting in 2028
- staged reform: minimal or modest reform in 2025, moving to expanded reform in the next Senedd term
- or do you have other views or ideas about the approach WG should take to the pace of reform

We believe a steady and measured approach towards a more progressive council tax system is prudent, as it will provide an opportunity to review the impact of the phased reforms.

The reforms should commence from April 2025 starting with a national revaluation of domestic properties - by using the existing nine band council tax system (and retention of the existing band ratios).

Thereafter, we consider further reforms should be made in the next Senedd term to implement a more radical and progressive tax system by moving to the expanded reforms as set out in the consultation document.

[Do you agree there should be an overall time-limit on Exemption F to discourage properties being left empty and exempt from Council Tax for an indefinite period?](#)

- [Yes](#)
- [No](#)

Yes, we fully support the proposed changes to time-limit the Class F exemption, especially as in some cases, the period of exemption can last several years, and the current arrangements of awarding an unlimited council tax exemption does not provide an incentive to bring the properties back into full use.

[What do you consider is a reasonable period for obtaining probate or letters of administration?](#)

- [Two Years](#)
- [Three years](#)
- [Four years](#)
- [Other \(please specify\)](#)

No two cases are ever the same and the time it takes to obtain probate will differ from one estate to the next. In most cases, probate or letters of administration are granted quickly and the average timeline, across England and Wales, from submission to grant is currently 14 weeks.

We therefore believe that a one-year time-limit should be implemented which will still provide adequate safeguard for complex cases. A one-year limit to apply for probate or letters of administration will act as an incentive for the personal representatives to apply for probate and not to delay matters.

The time-limit will also ensure properties are re-occupied as soon as possible, either by family members or beneficiaries of the estate, or through an eventual sale of the property.

In reaching this conclusion, we also consider that once probate has been awarded, a further six months statutory exemption will continue to apply for the beneficiaries/new owners before council tax payments are due. We therefore believe the measures are proportionate and reasonable.

Which title do you think should replace the term 'severely mentally impaired'?

- Option A: significant brain impairment
- Option B: significant brain condition

We do not support the proposed changes as the language used in the Local Government Finance Act 1992 to describe someone as 'severely mentally impaired' continues to be aligned to the Mental Health Act 1983.

The 'severe mental impairment' term is widely recognised and well established.

Do you agree with the proposed definition to describe a person with a significant brain impairment or condition? The definition is: "Significant (and permanent) mental condition or change that impacts on the brain's ability to function."

- Yes
- No

No – see above.

Do you have any views on the qualifying criteria for a person with a significant brain impairment or condition to be entitled to an exemption or disregard? The current qualifying criteria are for a person to be entitled to a qualifying benefit and to have medical certification from a registered practitioner.

- Option A: remove the requirement for a person to be entitled to a qualifying benefit in order to qualify for the exemption or disregard but retain the need for a medical certification.
- Option B: where a person can provide proof of clinical diagnosis, the requirement for a person to be in receipt of a qualifying benefit could be removed at the discretion of the Council.
- Other (please specify)

There are 865 households in Flintshire that qualify under this scheme, of which 358 are fully exempt from council tax. The other 507 households may get a 25% reduction, a 50% reduction on the odd occasion or no discount at all e.g. there are 3 adults and only 1 disregard.

The current system works well. There is a simple application process to ensure residents can submit supporting statements from a medical practitioner and confirm details of their supporting benefit/s.

To be eligible for a council tax reduction, we firmly believe there is a continued need to retain the qualifying criteria for a person to be entitled to a qualifying DWP benefit and to also have a medical certification from a registered general practitioner or specialist consultant.

Retaining the need for residents to be in receipt of qualifying benefits helps to validate and fast-track council tax exemption applications.

Crucially, we often receive applications from residents with severe mental impairments who are completely unaware of the range of benefits that are available to them, such as Universal credit (including an element for limited capability for work), attendance allowance, Disability Living Allowance etc.

In several cases, it is only at the point of the council tax exemption application that residents are made aware of, and signposted to, the additional supporting DWP benefits.

There is a vital correlation between the two schemes and any break between the two would result in silo working arrangements and reduce the awareness of benefits that are available to residents. More importantly, removal of the qualifying benefits link would result in unintended consequences as residents are likely to miss out on access to the additional DWP benefits.



# Eitem ar gyfer y Rhaglen 10



## CABINET

<b>Date of Meeting</b>	Tuesday, 16 <sup>th</sup> January 2024
<b>Report Subject</b>	Street Lighting, Traffic Signals and External Electrical Infrastructure Policy 2023-2028
<b>Cabinet Member</b>	Deputy Leader of the Council and Cabinet Member for Streetscene and Regional Transport Strategy
<b>Report Author</b>	Chief Officer (Streetscene and Transportation)
<b>Type of Report</b>	Strategic

### EXECUTIVE SUMMARY

Street lighting provides illumination for various types of highway and public open spaces, assisting road safety and ease of passage for all users in the hours of darkness. Improved visibility reduces the likelihood of traffic collisions and improves road safety. There is no legal requirement on local authorities in the UK to provide street lighting for any highway or proposed highway under its responsibility; however, the Council does have a duty to ensure that lighting units are maintained in a safe condition. Street lighting can enhance the night-time economy and encourage the use of facilities, as well as contributing to the general well-being within communities. It has a wider social role, helping to reduce crime and the fear of crime, and can contribute to commercial and social use of town centres, shopping areas and tourist locations at night-time.

The last time the policy was reviewed was in 2015 when the standards were amended for repairing street lighting faults and the frequency of night-time inspections were revised, as well as including provision for part-night lighting and dimming lights.

The draft policy sets out the responsibilities, requirements and standards for all new or replacement external public highway lighting, and aims to incorporate, wherever practicable, all relevant codes of practice and legislation, together with industry best practice and national policies. The revised policy being presented for consideration with this report takes into account additional electrical infrastructure, such as electric vehicle charging, vehicle activated signs and defibrillators.

### RECOMMENDATIONS

1	That Cabinet notes the portfolio's performance against the current standards and policy.
2	That Cabinet supports the revised Street Lighting policy

**REPORT DETAILS**

<p><b>1.00</b></p>	<p><b>BACKGROUND TO THE STREET LIGHTING POLICY AND PROVISION OF STREET LIGHTING AND ASSOCIATED ELECTRICAL EQUIPMENT</b></p>
<p>1.01</p>	<p>Street lighting provides illumination for various types of highway and public open spaces, assisting road safety and ease of passage for all users in the hours of darkness. Improved visibility reduces the likelihood of traffic collisions and improves road safety.</p> <p>There is no legal requirement on local authorities in the UK to provide street lighting for any highway or proposed highway under its responsibility; however, the Council does have a duty to ensure that lighting units are maintained in a safe condition. Street lighting can enhance the night-time economy and encourage the use of facilities, as well as contributing to the general well-being within communities. It has a wider social role, helping to reduce crime and the fear of crime, and can contribute to commercial and social use of town centres, shopping areas and tourist locations at night-time.</p>
<p>1.02</p>	<p>Under the Highways Act 1980, the Health and Safety at Work Act 1974 and Electricity at Work Regulations 1989, the Council has a duty to maintain its assets in a safe condition. The Council also has a statutory duty to provide traffic signals and certain illuminated traffic signs and bollards as prescribed within the Traffic Signs and General Directions Act 2023.</p> <p>Under the Highways Act 1980, there is no statutory requirement for local authorities to provide public lighting. However, Councils do have the power to provide lighting for any highway or proposed highway for which they are the designated Highway Authority. The Council also has a duty under Section 17 of the Crime and Disorder Act 1998 to exercise its lighting function with regard to its effect on crime and disorder in an area. Section 39 of the Road Traffic Act 1988 also places statutory duties on the Council to promote road safety. The policy also relates to the following pieces of legislation and codes of practice:</p> <ul style="list-style-type: none"> <li>• Code of Practice for Well-Managed Highway Infrastructure</li> <li>• British Standards 5489-1:2020</li> <li>• Construction, Design and Management (CDM) Regulations</li> </ul>
<p>1.03</p>	<p>The Council currently owns and maintains 112 traffic signal junctions, 21,300 street lighting units, 3,250 illuminated signs and bollards, 122 vehicle activated signs (VAS) along with various other electrical equipment ranging from feeder pillars, car park ticket machines, illuminated warning lights, defibrillator power sources, speed camera supplies, electric vehicle charging point supplies etc. across the county. In addition, the Council maintains the street lighting and associated infrastructure on behalf of the North and Mid-Wales Trunk Road Agency (NMWTRA), which adds an additional 12 traffic signal junctions across north-east Wales (Wrexham, Flintshire and Denbighshire), 2,500 lighting units, 450 illuminated signs and bollards and a number of other electrical assets.</p>

1.04

## **Budget, Resources and Asset Management**

- a) The street lighting and traffic signal budget for 2023-2024 is £296,000 (excluding energy costs). This covers all aspects relating to the maintenance of the electrical and illuminated infrastructure within the adopted highway network.
- b) The resources required to deliver the current street lighting service is 5 FTE electricians plus a supervisor. This includes 1 FTE that is self-funded by the costs recovered from external work for NMWTRA and Town and Community Councils.
- c) Approximately 60% of the lighting assets i.e. 12,050 columns and 1,820 illuminated signs and bollards, are older than their anticipated 30-year life expectancy and we are seeing significant costs arising from structural inspections with a high failure rate and an increasing 1-yearly re-inspection requirement, which is likely to lead to a high replacement need in the coming years.
- d) Currently, 673 columns have been identified as requiring immediate and complete replacement or removal along with approx. 220 illuminated signs that require attention in this financial year with replacement costs in the region of £1.79m. These columns are regularly inspected to ensure that their continuing structural integrity are known. At the present time, around 160 columns per year require immediate action or replacement because of their structural integrity identified following the Council's structural testing regime.
- e) In addition to this and more commonly following the structural testing, which is scored on a six yearly basis chart, we are seeing an increase in one yearly re-visits, which over time will result in a substantial number of columns requiring replacement or action in a future financial year.
- f) The current estimated costs for known street lighting column replacements not including illuminated signs and bollards is £1.35m. This is likely to increase with time and currently it is estimated that we could see costs rising by £400k per year on top of the current requirement costs. There is no budget allocated or available for the replacement of these columns and there is no funding for capital improvements to the lighting infrastructure.
- g) There are also 6 traffic signal sites across the county that have been identified as failing in our annual survey, which are being kept operational through regular repairs and maintenance, but are considered beyond design life with spares availability for outdated equipment running extremely low.
- h) Following this year's maintenance regime of the traffic signal units, a further 8 sites have been identified for future replacement in addition to the 6 sites in the coming year. We will also need to replace all halogen lighting units in the coming 18 months due to new legislation and end of manufacturing of parts. Indicative costs have been obtained from the contractor and vary, as some sites can be upgraded to new replacement light sources while others require a complete signal head and associated parts change.

	<p>i) A cost has been sought to replace the units from halogen to LED; however, the indicative costs for this are prohibitively high. Funding is required for replacement. The sites that have exceeded their life and are failing* are as follows (*please note not failed, but failing):</p> <p>FC 252 – A548 Gronant  FC 307 – A541 Chester Road, Mold  FC 101 – B5127 The Cross, Buckley  FC 300 – B5444 King Street / Earl Street, Mold  FC 302 – A5119 The Cross, Mold  FC 345 – B5101 Keepers Lodge, Llanfynydd</p> <p>j) These sites have been classified as Priority 1, which require immediate attention and are constantly being attended to either for failures or replacement parts that are now nearly impossible to source. As a result, we are having to use stock from older sites that have replaced in the last few years, but these have been depleted too. There are also a large number of Priority 2 locations which are considered to be “out of age” sites and again, we are struggling to obtain spare parts for this equipment, and they will soon become an issue, requiring immediate attention at point of failure.</p> <p>k) <u>Energy Costs</u>  The annual consumption and cost of electricity for street lighting and traffic signal units is currently approximately £950,000k per annum, based on the current rate of pence per kilowatt hour (ppkwhr). The portfolio is currently reporting an in-year budget pressure of around £200k for street lighting due to increased energy costs.</p>
1.05	<p><b>Reporting Faulty Lights or Equipment</b>  Faults involving streetlights are usually caused by the failure of the lamp or other electrical component. In a minority of cases, the fault may be due to the failure of the electricity supply, vandalism or accident damage. Any faults which may occur with this equipment are repaired by the Council, utilising the Council’s in-house street lighting service within Streetscene and specialist contractors under contract as and when required.</p> <p>Supply faults are the responsibility of the Network Management Organisation (normally Scottish Power), who is responsible for providing the electricity supply to the column.</p> <p>Street lighting faults are reported the Contact Centre (via 01352 701234 or via email/webpage). The Contact Centre logs the fault on the Customer Relations Management (CRM) system with the road name, asset number and location within the highway and nature of the fault, which is then passed to the portfolio and logged on the asset management system (Mayrise), which shows the location of Council owned lighting units and electrical assets.</p> <p>Town and Community Council lights that are maintained by the Council will also be entered onto the Mayrise software system and highlighted to ensure that the operator is aware of the specific ownership details. The Mayrise system holds the location of units maintained by Streetscene and these are reported and added to the system in the same process as Flintshire County Council assets.</p>

	<p>Once the fault notifications have been logged onto the Mayrise software system, they are then sent electronically to a tablet device for the electrician to carry out the necessary repairs.</p>
<p>1.06</p>	<p><b>Response Times</b></p> <p>The policy sets out the current response times, which are also included in the Streetscene Standards. Emergency or Urgent fault timeframes will apply until the fault is made safe and then allocated for final repair, if required, to the most appropriate fault code prioritisation timeframe following the make safe.</p> <p>These are as follows: -</p> <ul style="list-style-type: none"> <li>• *Emergency call outs - Attend site in 2 hours: <ul style="list-style-type: none"> <li>- damage to underground cable / overhead cable (FCC owned)</li> <li>- exposed cable / metal work reported as live</li> <li>- column door missing</li> <li>- lantern or bowl hanging</li> <li>- column or pole swaying in wind</li> <li>- structurally unsafe column or pole</li> </ul> </li> <li>• Urgent fault - 1 working day: <ul style="list-style-type: none"> <li>- lanterns or brackets turned or misaligned presenting a danger to the public</li> <li>- columns leaning but presenting no clear danger</li> <li>- bollard heads turned or misaligned presenting a danger to the public</li> <li>- miscellaneous faults deemed as a danger to the public</li> </ul> </li> <li>• Faults in supply system affecting apparatus - Regional Electricity Company informed within 24 hours</li> <li>• Fault reported to Street Lighting section - 10 working days</li> <li>• Faults found on night-time inspections - 7 consecutive days</li> <li>• Routine (cyclical maintenance) - 90 days</li> </ul> <p>Most street lights take their electricity from the mains supply so will fail if there is any loss of power or if there is a problem with the cable. We will report these faults to the electricity company. The performance targets for electricity company responses are defined by OFGEM and are as follows:</p> <ul style="list-style-type: none"> <li>• Emergency fault repair response - Attend site in 2 hours</li> <li>• High priority fault repair, traffic light controlled - 2 calendar days</li> <li>• High priority fault repair, non-traffic light controlled - Within 10 working days</li> <li>• Multiple unit fault repair - Within 20 working days</li> <li>• Single unit fault repair - Within 25 working days</li> </ul> <p>A high priority fault repair is a fault which is considered to be urgent, for example at the site of an accident blackspot, major road junction or an area of public order concerns.</p> <p>The number of reported faults received by the portfolio in recent years is as follows (not including internal and maintenance reported faults):</p> <p>2020/2021 - 604 2021/2022 - 1021</p>

	<p>2022/2023 - 931</p> <p>The service performance for responding to faults in recent years has been as follows:</p> <p>2020/2021 – 27.6 days  2021/2022 – 13.4 days  2022/2023 – 7.2 days</p> <p>The current standard for mains supply faults is 18 working days (i.e. those not the responsibility of the Council). The Council has recently been successful in obtaining financial compensation from the Network Management Organisation, where they have failed to meet this agreed standard.</p>
1.07	<p><b>Inspections, Repairs and Maintenance</b></p> <p>Night-time driven visual inspections are carried out every 28 days in the Summer months (April to September) and 14 days in the Winter months (October to March). Items checked include:</p> <ul style="list-style-type: none"> <li>• Lanterns which are dark or non-operational</li> <li>• Lamps not fully run up or flickering</li> <li>• Lanterns turned or misaligned</li> <li>• Lanterns obscured by foliage</li> <li>• Lantern bowls hanging, missing or suffering major damage</li> <li>• Column doors missing</li> <li>• Brackets misaligned</li> <li>• Columns leaning</li> </ul> <p>Routine maintenance is carried out tri-annually and split across schedule programmes of work. This includes:</p> <ul style="list-style-type: none"> <li>• Clean all lamps, reflectors and other components affecting optical performance.</li> <li>• Examination of superficial damage, corrosion, chipping, flaking or cracking (concrete columns), cable deterioration, reporting condition.</li> <li>• Inspect all electrical items rectifying where necessary.</li> <li>• Check correct operation of photoelectric cell or associated switching device.</li> <li>• Adjust clocks to correct time where photoelectric cells are not fitted.</li> <li>• Non-routine maintenance is carried out as required.</li> </ul> <p>Bulk lamp changing of lamps takes place on main routes and in the town centres on a three and four-year cycle based upon lamp source for Street Lighting Lanterns and signs where such lanterns are still installed.</p> <p>Structural testing and inspection of columns is carried out in accordance with TR22 every year based upon a one, three and six year regime. Currently Flintshire County Council inspect and test approx. 2000 units per year.</p> <p>Electrical testing is carried out every six years in accordance with BS 7671.</p>

1.08	<p>The Council is responsible for the structural integrity of all its electrical assets on the adopted highway network, including the street lighting columns and the electrical apparatus within them. This extends to all infrastructure which is placed upon, within and over the adopted network. Additionally, the Council is responsible as highway authority (but not always at the Council's cost) for all assets installed to and from these.</p> <p>Such applications and infrastructure to this could be any electrical or illuminated assets, which span across or over any adoptable Council infrastructure regardless of ownership. An example of these maybe festive illuminations or remembrance poppies erected onto street lighting columns. All such installations require formal approval to be erected onto Flintshire County Council's infrastructure along with full compliance with the appropriate specification and legal requirements. Such applications should be made directly to the Operational North and Street Lighting Manager on the relevant form within the street lighting specifications.</p> <p>We are not responsible for and do not maintain lighting or electrical assets on unadopted or private roads.</p>
1.09	<p>Some Town and Community Councils (T&amp;CCs) own and maintain their own footway lighting columns which total approximately 3,000 units. Approximately half of the T&amp;CC's subsequently contract the Council to carry out the necessary repairs and maintenance on their behalf with the remaining Councils contracting the work to private contractors or organisations.</p> <p>All T&amp;CCs must follow the same standards, rules and regulations as the County Council, and they must submit when requested, the relevant information to Streetscene to demonstrate compliance with the Highways Act 1980.</p> <p>There are variations in the way T&amp;CC owned footway lighting is maintained i.e. either via the County Council or through independent contractors.</p> <p>Where the T&amp;CC then contracts the Council to carry out the work, the lighting is maintained to the same standard as Council owned lighting. Whilst details of the lights are being entered onto the Council's inventory, complaints regarding faults are received directly into the Contact Centre and passed to the electricians electronically to carry out the necessary repair work.</p> <p>Once details of the T&amp;CC inventories have been gathered, the lighting units owned by the T&amp;CC's will be managed in exactly the same manner as the County Council's own lighting and fault details will be passed electronically to the electricians.</p> <p>Street lighting is also installed on new housing estates where the roads (or footpaths) are to be adopted by Flintshire County Council. Developers are required to install lighting in accordance with our requirements and are responsible for all maintenance until formal adoption by the local authority takes place. This occurs only after a thorough inspection by the Council's street lighting supervisor or Operational North and Street Lighting Manager.</p>

1.10	<p><b>LED conversion / Dimming lights / Part night lighting</b></p> <p>Like so many other councils across the country, we took the decision in 2015 to reduce carbon emissions and costs, through a phased introduction of new replacement LED light installation and the Council completed a two-year programme to convert all the county’s street lanterns to LED in 2019.</p> <p>All Flintshire County Council Streetscene lanterns have the ability to be dimmed and as such we dim a large number of lights between the hours of 22:00 and 06:00, resulting in energy savings of up to 30%. Most lanterns have automatic sensors (photocells), which turn them on at night at a selected illumination level and off when there is sufficient natural light. Other lights are set to turn on and off at specific times depending on location e.g. if road is overshadowed by dense trees or is a known accident hotspot.</p> <p>Many other local authorities have already introduced part night lighting schemes successfully and without adverse effects, which have made significant savings. With rising energy costs and reduced budgets these types of changes to street lighting are becoming more common.</p> <p>As part of the MTFS budget solutions for 2023-2024, work is ongoing to deliver further efficiencies either through consideration to extending part night lighting or dimming in line with the policy.</p> <p>Any areas proposed for part night lighting will be subjected to a risk assessment and consultation. Such consultations would include the Police, local ward members and other interested parties where required. By extending the part-night lighting a financial saving of approximately £12k per 1,000 lanterns will be delivered. This will be achieved by replacing the photocells on the lanterns installed at locations defined within the policy.</p> <p>Rapid technological advancements, particularly in the realm of illumination and control systems, coupled with a growing demand for electrical infrastructure to support various amenities, have necessitated a thorough review of the Street Lighting Policy. By embracing innovation and adopting a forward-thinking approach, the Council can ensure that its street lighting infrastructure remains efficient, sustainable, and well-equipped to meet the needs of the community.</p> <p>Lighting systems are designed to provide consistent levels of light in a road. Turning off every other light is not only likely to create pockets of darkness but also make it harder for the eyes to adjust and see clearly between lights.</p> <p>Modern light sources and lanterns are designed with improved optical control to concentrate the light downwards onto the street rather than permit spillage upwards into the night sky. Any new illumination sources that we install are designed to minimise light pollution in this way and older lights will gradually be replaced with these at the end of their life.</p>
1.11	<p><b>Policy Review</b></p> <p>The current policy covers all aspects of the service, including adoption, installation and the various maintenance regimes, which are essential for maintaining the system in a safe an efficient state of repair.</p>



	<p>The review of the Street Lighting Policy and amendments to the specifications for electrical assets have been prompted by a number of changes and advancements in technology, not only in light emitting diodes for illumination and electronics for control systems, but also due to the additional requirement and number of requests for the installation of certain electrical assets within and on adoptable and maintained Council infrastructure, such as vehicle activated signs, defibrillators and electrical vehicle (EV) charging points. Additionally, the recent consultation on the potential for a new national park encompassing large parts of the west of the county and the Clwydian Range will need to be taken into account.</p> <p>The new policy sets out the responsibilities, requirements and standards for all new or replacement external public highway lighting, and aims to incorporate, wherever practicable, all relevant codes of practice and legislation, together with industry best practice and national policies.</p>
--	---

<b>2.00</b>	<b>RESOURCE IMPLICATIONS</b>
2.01	<p><b>Revenue:</b> The portfolio is currently reporting an in-year budget pressure of £200k for street lighting due to increased energy costs.</p> <p>As part of the MTFs budget solutions for 2023-2024, work is ongoing to deliver further efficiencies either through extending part-night lighting or light dimming in line with the policy. By extending the part-night lighting a financial saving of approximately £12k per 1,000 lanterns will be delivered. This will be achieved by replacing the photocells on the lanterns installed at locations defined within the policy.</p> <p><b>Capital:</b> As outlined in Section 1.04, a number of street lighting assets and electrical infrastructure are now at a critical stage and in urgent need of replacement. A bid has been submitted to the Capital Programme Board for 2024-2025 for the most critical assets and will be subject to sufficient budget being available and approval by the Board.</p> <p><b>Human Resources:</b> There are no known implications for additional capacity or for any changes to current workforce practices, structures or roles as part of this policy review.</p>

<b>3.00</b>	<b>IMPACT ASSESSMENT AND RISK MANAGEMENT</b>	
3.01	<b>Ways of Working (Sustainable Development) Principles Impact</b>	
	Long-term	Positive – the revised street lighting policy can help with Council’s carbon reduction and reduce light pollution, energy consumption, carbon emissions, and costs, while improving safety, health, and well-being for people and wildlife
	Prevention	Positive – prevention of problems by adopting a responsible outdoor lighting policy: sufficient

	light, glare control, light trespass reduction, sky glow reduction, and energy conservation
Integration	Neutral - integration of sustainable development into all aspects of operations
Collaboration	Neutral – continue to collaborate with other departments, organisations and sectors e.g. Town & Community Councils, developers
Involvement	Neutral - engaging with local communities and stakeholders to understand their needs and preferences for street lighting, and to raise awareness of the benefits of sustainable lighting
<b>Well-being Goals Impact</b>	
Prosperous Wales	Positive - The development of street lighting and technology will ensure that infrastructure is innovative and contributes to a low carbon society which recognises the limits of the global environment and therefore uses resources efficiently and proportionately.
Resilient Wales	Positive – Street lighting is an important aspect of urban infrastructure that can affect the safety, security, and sustainability of communities. Street lighting can help to promote security and deter crime or reduce the fear of crime by increasing visibility and surveillance. Reducing energy consumption and carbon emissions by switching to more efficient LED lights, dimming lights at off-peak hours, or using renewable energy sources contributes to a resilient Wales. Additionally, street lighting can contribute to a resilient Wales by enhancing road safety and reducing traffic accidents by providing adequate illumination and visibility for all road users.
Healthier Wales	Positive - street lighting can improve the quality of life, health, safety, resilience and sustainability of people and communities by extending the hours of activity and reducing the fear of active travel at night. It can also improve the safety and comfort of road users by reducing the risk of accidents and collisions. However, street lighting can also have negative impacts on the environment, wildlife and human health if not installed efficiently, sensitively or carefully, such as increased light pollution, increased energy consumption and disruption of circadian rhythms and habitats.
More equal Wales	Positive - Street lighting can have various impacts on society, such as road safety, crime prevention, environmental sustainability, and social inclusion. Street lighting can also affect the well-being and quality of life of people, especially those who live in rural or

		disadvantaged areas. Street lighting can provide a sense of security, comfort, and belonging, as well as enable social and economic activities after dark. Therefore, street lighting can be seen as a way of promoting social justice and equality, by ensuring that everyone has access to the benefits of public lighting, regardless of their location, income, or background.
	Cohesive Wales	Positive – Street lighting can help to deter crime and antisocial behaviour by creating a sense of surveillance and community cohesion.
	Vibrant Wales	Positive - Street lighting can create liveable spaces that enhance social engagement, public services, and community pride, as well as supporting local economy and social inclusion by facilitating night-time activities, such as shopping, entertainment, or cultural events.
	Globally responsible Wales	Positive - how street lighting is designed, operated and maintained can affect how Wales contributes to global well-being. Some of the ways that street lighting can contribute to this goal are by using energy-efficient technologies, such as LED lamps, that reduce greenhouse gas emissions and save costs, implementing smart lighting systems, such as dimming, switching off or adjusting the colour of lights, that respond to traffic, weather and ambient light condition, and by minimising light pollution.
	<p>The policy also links to the Council’s <b>Well-being Objectives</b> 2022-2023 in terms of supporting safer communities and limiting the impact of the Council’s services on the natural environment and supporting the wider communities of Flintshire to reduce their own carbon footprint.</p> <p>The provision of street lighting also aims to contribute to the Council’s priorities in terms of providing a well-connected, safe and clean local environment and supporting people in need to love as well as they can by creating resilient communities where people feel connected and safe.</p>	

<b>4.00</b>	<b>CONSULTATIONS REQUIRED/CARRIED OUT</b>
4.01	Deputy Leader of the Council and Cabinet Member for Streetscene and Regional Transport Strategy.

4.02	With the Environment & Economy Overview & Scrutiny Committee.
------	---

<b>5.00</b>	<b>APPENDICES</b>
-------------	-------------------

5.01	Draft Street Lighting, Traffic Signals and External Electrical Infrastructure Policy – To be presented at Cabinet. Specifications for Street Lighting, Traffic Signals and External Electrical Infrastructure – To be presented at Cabinet.
------	--

<b>6.00</b>	<b>LIST OF ACCESSIBLE BACKGROUND DOCUMENTS</b>
-------------	--

6.01	None.
------	-------

<b>7.00</b>	<b>CONTACT OFFICER DETAILS</b>
-------------	--------------------------------

7.01	<p><b>Contact Officer:</b> Barry Wilkinson, Highway Network Manager  <b>Telephone:</b> 01352 704656  <b>E-mail:</b> <a href="mailto:barry.wilkinson@flintshire.gov.uk">barry.wilkinson@flintshire.gov.uk</a></p> <p><b>Contact Officer:</b> Darell Jones, Operational North and Street Lighting Manager  <b>Telephone:</b> 01352 701290  <b>E-mail:</b> <a href="mailto:darell.jones@flintshire.gov.uk">darell.jones@flintshire.gov.uk</a></p>
------	--

<b>8.00</b>	<b>GLOSSARY OF TERMS</b>
-------------	--------------------------

	<p><b>British Standards 5489-1:2020</b> – the standards provide recommendations for the general principles of road lighting, including aesthetic, technical, operational and maintenance aspects. It also provides guidance on energy consumption and environmental impacts, and considers the design of lighting for all types of highways, public thoroughfares and pedestrian and cyclists subways and bridges. It also covers the design of lighting for urban centres and public amenity areas, including lighting relating to smart cities</p> <p><b>British Standards 7671:2018</b> (18th edition) – the standards provide recommendations for the general principles of Electrical infrastructure and the current standard used in the UK. It came into effect from 1st January 2019 and is the national standard used for electrical installation and wiring safety across domestic, commercial, and industrial properties.</p> <p><b>Code of Practice for Well-Managed Highway Infrastructure:</b> The UK Road Liaison Group (UKRLG) publish a Code of Practice for Highway Authorities to following respect of highway maintenance (the Code). Whilst this Code does not place a statutory requirement on the Council, it provides Highway Authorities with guidance on highways management arrangements. Adoption of the recommendations within the Code is a matter for each Highway Authority, based on their own legal interpretation, risks, needs and priorities. The code advocates a risk-based approach to highway management, which is followed in the Council’s HAMP, which recognises resource availability and prioritises areas in</p>
--	---

the greatest need, in order to provide the maximum benefit from the available investment.

**Institution of Lighting Professionals Guidance Note 22** - This is the structural inspection requirements for all asset owners who are responsible for lamp posts, traffic posts, traffic signal poles, signs, CCTV, WiFi, floral decorations or similar. The documentation states and highlights the current practices and requirements of structural testing of various structures and their scoring.

Mae'r dudalen hon yn wag yn bwrpasol

# Eitem ar gyfer y Rhaglen 11



## CABINET

<b>Date of Meeting</b>	Tuesday, 16 <sup>th</sup> January 2024
<b>Report Subject</b>	Unsafe Memorials in Flintshire Cemeteries
<b>Cabinet Member</b>	Deputy Leader of the Council and Cabinet Member for Streetscene and Regional Transport Strategy
<b>Report Author</b>	Chief Officer, Streetscene & Transportation
<b>Type of Report</b>	Operational

### EXECUTIVE SUMMARY

Bereavement Services currently manage 15 cemeteries and 8 closed church yards located throughout Flintshire. Within these cemeteries, the council undertakes approximately 400 interments annually, both full body and cremated remains.

The service is responsible for approximately 20,000 memorials of varying shapes and sizes. To comply with the Local Authorities Cemetery Order 1977 (LACO) and under the Ministry of Justice guidance on “Managing the safety of Burial Ground Memorials”, Flintshire County Council (FCC) has a duty to maintain its burial grounds in good and safe order.

To ensure compliance, we currently test all memorial gravestones (“memorials”) within our cemeteries once every three years to ensure safety and stability. Unsafe memorials are gravestones that have become loose or unstable and pose a risk of injury to visitors or our employees and any memorials that fail the testing process are temporarily supported by wooden stakes and the grave owners are contacted (where known) to request that they undertake a permanent repair.

A combination of the absence of records and/or absence of surviving family members willing to undertake the repairs and maintenance on memorials has resulted in approximately 700 memorials within Flintshire’s cemeteries being deemed to be structurally unsafe. Whilst these memorials continue to be supported by wooden stakes, a permanent solution has yet to be implemented. In addition to unsafe memorials, kerb sets within the council’s older cemeteries are also falling into disrepair, resulting in potential trip hazards.

The purpose of this report is to seek support and approval for an alternative and permanent method of making the memorials safe, if the memorial is not repaired by the registered grave owner, as well as the making safe of any kerb sets that have become detached from the main structure of the grave.

## RECOMMENDATIONS

1	That Cabinet supports the proposal to adopt the “digging in” method to stabilise those memorials deemed to be structurally unsafe when the grave owners cannot be traced. This approach will address the ongoing health and safety risk associated with unsafe memorials that only currently receive a temporary short-term fix.
2	That Cabinet supports the proposal to address unsafe kerb sets by repositioning all kerb sections within the structure of the grave – either above or below the surface depending on the presence of a concrete slab foundation.

## REPORT DETAILS

<b>1.00</b>	<b>EXPLAINING THE BACKGROUND TO SAFETY CONCERNS FOR MEMORIALS IN FLINTSHIRE CEMETERIES</b>																																
1.01	Bereavement Services currently manage 15 cemeteries and 8 closed church yards located throughout Flintshire. In addition, the service also has 2 gardens of remembrance located at Hawarden and Kelsterton, a dedicated child and baby memorial at Kelsterton cemetery and a woodland / natural burial area also located at Kelsterton cemetery.																																
1.02	<p>Within the cemeteries, the council undertakes approximately 400 interments annually, both full body and cremated remains. A list of burial locations has been provided below for information: -</p> <table border="1"> <thead> <tr> <th>Cemetery</th> <th>Closed Churchyards</th> </tr> </thead> <tbody> <tr> <td>Bagillt</td> <td>Ddol Chapel, Afonwen</td> </tr> <tr> <td>Bryn Road, Connah’s Quay</td> <td>Ffordd y Llan, Cilcain</td> </tr> <tr> <td>Buckley</td> <td>Old Churchyard, Halkyn</td> </tr> <tr> <td>Flint - London Road</td> <td>St James, Holywell</td> </tr> <tr> <td>Flint - Northop Road</td> <td>St Peters, Holywell</td> </tr> <tr> <td>Greenfield No 1</td> <td>Trelawnyd</td> </tr> <tr> <td>Greenfield No 2</td> <td>Tyddyn Street, Mold</td> </tr> <tr> <td>Hawarden No 1</td> <td>Vownog Road, Sychdyn</td> </tr> <tr> <td>Hawarden No 2</td> <td></td> </tr> <tr> <td>Holywell</td> <td></td> </tr> <tr> <td>Hope - Bryn y Grog</td> <td></td> </tr> <tr> <td>Hope - Old</td> <td></td> </tr> <tr> <td>Kelsterton</td> <td></td> </tr> <tr> <td>Rhewl</td> <td></td> </tr> <tr> <td>Treuddyn</td> <td></td> </tr> </tbody> </table>	Cemetery	Closed Churchyards	Bagillt	Ddol Chapel, Afonwen	Bryn Road, Connah’s Quay	Ffordd y Llan, Cilcain	Buckley	Old Churchyard, Halkyn	Flint - London Road	St James, Holywell	Flint - Northop Road	St Peters, Holywell	Greenfield No 1	Trelawnyd	Greenfield No 2	Tyddyn Street, Mold	Hawarden No 1	Vownog Road, Sychdyn	Hawarden No 2		Holywell		Hope - Bryn y Grog		Hope - Old		Kelsterton		Rhewl		Treuddyn	
Cemetery	Closed Churchyards																																
Bagillt	Ddol Chapel, Afonwen																																
Bryn Road, Connah’s Quay	Ffordd y Llan, Cilcain																																
Buckley	Old Churchyard, Halkyn																																
Flint - London Road	St James, Holywell																																
Flint - Northop Road	St Peters, Holywell																																
Greenfield No 1	Trelawnyd																																
Greenfield No 2	Tyddyn Street, Mold																																
Hawarden No 1	Vownog Road, Sychdyn																																
Hawarden No 2																																	
Holywell																																	
Hope - Bryn y Grog																																	
Hope - Old																																	
Kelsterton																																	
Rhewl																																	
Treuddyn																																	
1.03	The management of cemeteries is, in the main, covered by the Local Authorities Cemetery Order 1977 (LACO). Whilst there is no statutory duty placed upon the authority to provide burial space for any specific community or religious group, if the council exercise its powers to provide burial space, the LACO and the Ministry of Justice guidance on “Managing the Safety of Burial Ground Memorials” places a duty upon the authority to maintain its burial grounds in a																																



	<p>good and safe condition. According to the Ministry of Justice, the risk of any injury from an unsafe memorial is extremely low, but it should be managed in a sensible and proportionate way.</p>
1.04	<p>Some of the factors that can cause memorials to become unsafe include weathering, vandalism, ground movement, poor installation historically, and age. Burial ground operators have a legal responsibility to ensure the safety of their premises, and they can inspect and test memorials for stability using various methods. However, they should also act with sensitivity and respect towards the bereaved families and the historical and environmental value of the cemeteries.</p>
1.05	<p>In 2001, the Health and Safety Executive (HSE) launched a campaign named “Be Respectful, Be Safe” to try to improve the safety of cemeteries and churchyards following the recording of 21 serious accidents, including seven fatalities involving unsafe memorials over a 10-year period across the UK. This placed a requirement upon local authorities to regularly inspect all memorials under their responsibility, for which a minimum inspection standard of once every five years was stipulated.</p>
1.06	<p>To ensure compliance, we currently test all memorial gravestones (“memorials”) within our cemeteries once every three years to ensure safety and stability. If a memorial is found to be unsafe, Bereavement Services will try to contact the owner or the next of kin and ask them to arrange for repairs. If the owner cannot be traced or does not respond, we can take temporary measures to make the memorial safe, such as laying it flat, supporting it with wooden stakes or cordoning off the area. Currently, we have taken the approach of wooden stakes, as it was felt that laying the gravestone flat or cordoning it off would introduce additional risks, such as slips, trips and falls.</p> <p>A combination of the absence of records and/or absence of surviving family members willing to undertake the repairs and maintenance on memorials has resulted in approximately 700 memorials within Flintshire’s cemeteries being deemed to be structurally unsafe. Whilst these memorials continue to be supported by wooden stakes, a permanent solution has yet to be implemented. In addition to unsafe memorials, kerb sets within the council’s older cemeteries are also falling into disrepair, resulting in potential trip hazards.</p>
1.07	<p>In addition to the above requirement for routine inspection and testing, the National Association of Memorial Masons (NAMM) is an organisation that represents those involved in the memorial masonry industry and provides training and guidance on memorial masonry matters, such as the NAMM Code of Working Practice and the BS8415 Standard, which is recognised as the industry accepted standard for memorials in the UK.</p> <p>The BS8415 is a British Standard that specifies the minimum structural design criteria and performance requirements for new and reinstated memorials within burial grounds and memorial sites. It also applies to existing memorials that are repaired or re-fixed. The standard was first introduced in 2005 and has been revised several times, most recently in 2018. The aim of the standard is to ensure that the memorials are of good lasting quality and fit for purpose, requiring as little structural maintenance as possible.</p> <p>The standard is intended to support the memorial mason in complying with current guidance and to provide the customer with a memorial that meets their</p>

	<p>expectations and respects the dignity of the deceased. It also introduced a requirement in 2005 for all new or refixed gravestones to possess a ground anchor system that complies with the British Standard BS8415. The purpose of the ground anchor system is to prevent a memorial from suddenly toppling over. Although a memorial may still become loose over time, the headstone will not fail its safety inspection as the anchor system will prevent the stone from falling.</p>
1.08	<p>Whilst all headstone memorials installed after 2005 should no longer be of concern in terms of stability, we do need to be mindful that any memorial installed prior to this date will <u>not</u> possess a ground anchor system and may therefore pose a risk of toppling and potentially result in serious or catastrophic consequences.</p>
1.09	<p><b><u>Memorial Safety Programme</u></b></p> <p><u>Testing:</u></p> <p>Within the 15 cemeteries and 8 closed churchyards managed by the Council, there are approximately 20,000 memorials of varying shapes, sizes, condition and age.</p> <p>To comply with the duties stipulated within the LACO, the council adopted a memorial safety programme in 2008. Although the HSE recommends a minimum requirement for inspection once every five years, given the potential risk to the public associated with unsafe memorials, the council chose, at that time, to implement a more stringent testing regime with each memorial being both visually and hand tested for stability once every three years.</p> <p><u>Process of making safe &amp; repair:</u></p> <p>Those memorials that fail the testing process and are deemed to be unsafe, are then temporarily supported via the installation of wooden stakes placed at the rear of the headstone to prevent them from toppling, which are then banded (secured) to the memorial.</p> <p>Every effort is then made to contact the registered grave / memorial owner to inform them that the headstone has been tested and deemed to be unsafe and they are then requested to arrange a permanent repair to the headstone.</p> <p>Given that the majority of the stability test failures involve older memorials, we are finding more and more often that the registered grave / memorial owner cannot be traced or the named owner has either been interred within the identified grave or is of an age whereby the organising of a repair may not be possible.</p> <p>In such instances, the headstone will remain staked indefinitely; however, it is important to note that 'staking' is only a temporary repair and will not permanently address the highlighted health and safety risk – especially given the potential for wooden stakes to degrade within the ground over time.</p>
1.10	<p>To provide an indication of the scale of the problem in Flintshire, the following table has been created to show the number of memorials within our cemeteries that are currently supported with wooden stakes.</p>

Cemetery	Memorials currently staked for over 12 months
Buckley	26
Hawarden No 2	65
Bagillt	26
Flint - London Road	156
Flint – Northop Road	10
Connahs Quay	108
Greenfield No 1	24
Hawarden No 1	28
Hope Old	30
Holywell	64
Hope - Bryn y Grog	85
Rhewl	20
Kelsterton	0
Treuddyn	8
Greenfield No 2	0
<b>TOTAL:</b>	<b>650</b>

*\* The above table does not include Monolith (one-piece) Memorials which are often reported as potentially being unsafe. Whilst they may be leaning away from the perpendicular and may visually cause concern, such memorials in the main show no movement when tested given the continuation of the headstone below ground level, thus acting as an anchor system. They may, however, require straightening for aesthetic purposes.*

1.11

To address the risk of unsafe memorials, it is essential that the Council takes action to remove the hazard and prevent an instance of harm occurring, both to the public and the council's own workforce. Whilst the most obvious solution for repairing the council's unaddressed defective headstones (implemented pre-2008) would be to implement a ground anchor system in accordance with British Standard BS8415, this option would be considered cost prohibitive given the scale of the existing problem and current financial climate. Therefore, only the following options were considered and evaluated: -

Option 1: Removal of unsafe memorials.

All headstones that are deemed to be unsafe and cannot be repaired following liaison with the registered grave owner (when known and where possible) could be removed from the cemetery, thus addressing the health and safety risk. That said, not only could this approach be deemed as insensitive and disrespectful to the deceased, but it could also result in a high reputational risk for the authority, as well as implications for the storage and/or disposal of removed headstones.

For the reasons stipulated above, this approach is not considered to be an acceptable solution.

Option 2: Laying flat unsafe memorials.

All headstones that are deemed to be unsafe and cannot be repaired following liaison with the registered grave owner (when known and where possible) could be laid flat on the ground or on top of the existing burial plot. Whilst again, this

	<p>approach could be deemed as insensitive and disrespectful to the deceased and could result in a high reputational risk for the authority, it could also introduce a new safety risk for slips, trips and falls within the cemeteries.</p> <p>For the reasons stipulated above, this approach is not considered to be an acceptable option.</p> <p><u>Option 3: Digging In Method</u></p> <p>All headstones that are deemed to be unsafe and cannot be repaired following liaison with the registered grave owner (when known and where possible) could be addressed via the “digging in” method. The digging in method is a process whereby the memorial is moved from its location at the head of the grave, a hole approximately 18 inches in depth is dug and part of the headstone including its “shoe” is buried in the hole. The hole is then backfilled with excavated soil, thus making the memorial stable again. This method allows the majority if not all of the inscriptions on the headstone to be visible whilst creating a proven natural ground anchor system, similar to that utilised by Monolith (one-piece) Memorials. In the unlikely event that a previously visible inscription becomes submerged below ground level, a laminated photograph or transcript will be placed on the grave.</p> <p>This approach is considered to be the most reasonable option and can be easily achieved at a relatively low cost and minimal reputational risk to the authority.</p>
1.12	<p><b><u>Broken Kerb Sets</u></b></p> <p>In addition to the risk caused by unsafe headstones, kerb sets (lengths of stone that surround the perimeter of memorials) are also posing a safety concern within the council’s older cemeteries. Whilst the installation of kerb sets is no longer permitted practice in Flintshire, kerb sets were previously introduced in those cemeteries that were not designated “lawned cemeteries.”</p> <p>Kerb sets are contained within the following council cemeteries: -</p> <ul style="list-style-type: none"> <li>• Flint Northop Road</li> <li>• Hope old cemetery</li> <li>• Holywell</li> <li>• Connah’s Quay</li> <li>• Greenfield No 1 cemetery</li> <li>• Hawarden No 1 cemetery</li> <li>• Rhewl</li> </ul> <p>Given the age of the memorials where kerb sets have been installed, it is understandable that many of the graves are no longer tended by family members and, as such, a high percentage of kerb sets have sadly fallen into a state of disrepair or are broken.</p> <p>In many instances, the edges of the kerb sets are becoming separated from the main structure of the memorial and are falling into the walkways between graves and partially sinking into the ground, resulting in a trip hazard for visitors and cemetery staff, which may not be easily observed.</p>
1.13	<p>Whilst the exact number of graves with unsafe kerb sets has yet to be accurately determined, we are aware that it is a substantial problem. It is therefore</p>

essential that the Council takes action to remove the hazard and prevent an instance of harm occurring, both to the public and the council's own workforce. Unlike headstones, the method to address unsafe kerb sets is slightly more complex given the appropriate method of remedy will be dependent upon whether the grave in question has a concrete slab in situ.

The following options were considered for further investigation: -

Option 1: Removal of unsafe kerb sets.

All kerb sets that are deemed to be unsafe and cannot be repaired following liaison with the registered grave owner (when known and where possible) could be removed from the cemetery, which would address the health and safety risk. However, this approach could be deemed to be insensitive and disrespectful to the deceased and could result in a reputational risk for the authority. Consideration would also need to be given to the costs, storage and/or disposal of the defective kerb sets.

For the reasons stipulated above, this approach is not considered to be an acceptable option.

Option 2: Unsafe kerb sets on concrete slab foundation graves.

In the event that a kerb set has become detached from the concrete slab foundation and cannot be repaired following liaison with the registered grave owner (when known and where possible), the kerb sets could be laid centrally on top of the slab, which would address the health and safety risk whilst also preserving the structure of the grave in the event that a relative may wish to undertake a repair at a later date.

This approach is considered to be a reasonable solution for concrete foundation graves and can be easily achieved at relatively low cost and with minimal reputational risk to the authority.

Option 3: Proposed mitigation for earth graves (no concrete foundation).

In the event that a kerb set has become detached from the concrete slab foundation and cannot be repaired following liaison with the registered grave owner (when known and where possible), the kerb sets could be buried six inches below the surface of the grave, which would address the health and safety risk whilst also preserving the structure of the grave in the event that a relative may wish to undertake a repair at a later date.

This approach is considered to be a reasonable solution for earth graves and can be easily achieved at relatively low cost and with minimal reputational risk to the authority.

<b>2.00</b>	<b>RESOURCE IMPLICATIONS</b>
2.01	<b>Revenue:</b> There could be potential revenue implications for the proposals. Should approval not be given for the "digging in" method, then each of those memorials currently supported with wooden stakes would require re-staking

	every two to three years to ensure that the stakes were still fit for purpose and hadn't degraded. The current cost for having memorials staked via the appointed contract including materials is £9 per memorial. Therefore, the current revenue costs would be approximately £5,850.00 every two to three years. This cost will increase as more unsafe headstones are identified and not repaired by family members or next of kin.
2.02	<b>Capital:</b> There are no implications for the approved capital programme for either the current financial year or for future financial years.
2.03	<b>Human Resources:</b> In order to address the number of memorials and broken kerb sets currently identified, a team consisting of two operatives (Streetscene 2 and Streetscene 1) would need to be established to deal with the current backlog. It is estimated that this would take approximately 4 months to complete at a cost of approximately £17,000. Once the backlog has been cleared, any further identified unsafe memorials would be dealt with by the existing Bereavement Services team within current resource allocations.
2.04	Some initial equipment purchase may be required, such as lifting gantry for heavier memorials at a cost of approximately £1k, and "porters" trolleys at a cost of approximately £100 each, which could be purchased from within the existing revenue budget allocated for plant and equipment.

<b>3.00</b>	<b>IMPACT ASSESSMENT AND RISK MANAGEMENT</b>
3.01	Impact assessment is not required as this is an operational report, which seeks to remove an existing health and safety risk within the councils' cemeteries. The purpose of bringing the report to Cabinet is due to the sensitivity around memorials and potential reputational risks.
3.02	The lack of support or approval for either recommendation would potentially have a major reputational risk to the authority if it was deemed to have not taken appropriate action to address a known health and safety risk.
3.03	Whilst our current approach addresses the identified risk on a temporary basis and is currently in line with the service's risk assessments, support and approval of the stated recommendations would remove this risk.

<b>4.00</b>	<b>CONSULTATIONS REQUIRED/CARRIED OUT</b>
4.01	Consultation will be carried out with the local elected members and town / community councils, subject to approval.
4.02	A communications plan will need to be drafted and delivered, subject to approval and would involve publication and notification of the change in approach being publicised on the authority's website, social media platforms and within each cemetery.

<b>5.00</b>	<b>APPENDICES</b>
5.01	None

<b>6.00</b>	<b>LIST OF ACCESSIBLE BACKGROUND DOCUMENTS</b>
6.01	None

<b>7.00</b>	<b>CONTACT OFFICER DETAILS</b>
7.01	<p><b>Contact Officer:</b> Anthony Stanford, Transportation Manager  <b>Telephone:</b> 01352 704817  <b>E-mail:</b> <a href="mailto:anthony.stanford@flintshire.gov.uk">anthony.stanford@flintshire.gov.uk</a></p> <p><b>Contact Officer:</b> Richard Blake, Bereavement Services Manager  <b>Telephone:</b> 01352 703360  <b>E-Mail:</b> <a href="mailto:richard.blake@flintshire.gov.uk">richard.blake@flintshire.gov.uk</a></p>

<b>8.00</b>	<b>GLOSSARY OF TERMS</b>
8.01	<p>(1) <b>The National Association of Memorial Masons (NAMM)</b> –recognised industry body for the acceptable standard for which memorials should be fixed in the UK.</p> <p>(2) <b>Local Authorities Cemeteries Order 1977 (LACO)</b> - gives burial authorities wide ranging powers of management to do what is considered necessary or desirable for the management, regulation and control of the cemeteries.</p> <p>(3) <b>Ministry of Justice Guidance on “Managing the safety of Burial Ground Memorials</b> – sets out a risk-based approach to help operators develop a proportionate approach to managing the risks associated with memorials that is based on good practice.</p> <p>(4) <b>Kerb set</b> – A Grave Space that has a Headstone and stone or granite borders around its edges. The centre of these graves and also have chippings placed in them or sometimes have a solid granite or marble plinth.</p> <p>(5) <b>Monolith Memorial</b> – A one piece memorial with approximately one third of its height being sunk into the ground for stability.</p> <p>(6) <b>Digging in method</b> - process whereby the memorial is moved from its location at the head of the grave, a hole approximately 18 inches in depth is dug and the memorial including its shoe is placed in the hole. The hole is then backfilled, thus making the memorial stable again.</p> <p>(7) <b>Laying flat memorials</b> – Headstones that are laid flat on the surface of the grave due to concerns of structural stability.</p> <p>(8) <b>Concrete slab foundation graves</b> – burial plots that possess a concrete slab foundation for which a memorial is mounted.</p> <p>(9) <b>Natural earth graves</b> – burial plots that do not have a concrete slab foundation but consist of natural earth only.</p> <p>(10)<b>Registered Grave Owner (RGO)</b> – The Registered Grave Owner is the</p>

	<p>person who is issued with the Deeds for the Burial plot once it is first used. If a Registered Grave subsequently passes away, ownership of a Grave can be transferred to the Executor of the deceased estate or Next of Kin via a Statutory Declaration if no will is in place. The RGO controls any actions associated with the grave.</p>
--	---



# Eitem ar gyfer y Rhaglen 12



## CABINET

<b>Date of Meeting</b>	Tuesday, 16 <sup>th</sup> January 2024
<b>Report Subject</b>	Alarm Service Charge Review
<b>Cabinet Member</b>	Cabinet Member for Housing & Regeneration
<b>Report Author</b>	Chief Officer (Housing & Communities)
<b>Type of Report</b>	Strategic

### EXECUTIVE SUMMARY

The Council provides a range of services to residents, the community and visitors for which it can apply a fee or charge and generate income accordingly.

Within the Council's housing stock (HRA) there are 2592 sheltered housing accommodation units. Following a review of the warden service in 2009 this service was ceased, and the Community Based Accommodation Service (CBASS) was created.

The service provides a tenure neutral service for any older person in Flintshire who may need housing related support.

In addition, the service provides a response service for alarm activations. For HRA residents this is a 24-hour service, operating an out of hours service from within the team for outside office hours (evenings, nights and weekends)

The proposal is to apply the increased service charge to all sheltered residents who are currently using the alarm service. All new residents in sheltered schemes with an alarm will have the charge applied as per current process at the beginning of their new contract.

This report provides details of a proposal to increase the service charge to all sheltered residents who are currently using the alarm service and that the service charge will be applied to all sheltered properties at the point they are let in future.

## RECOMMENDATIONS

1	That Cabinet supports and endorses the proposal to achieve full cost recovery for the housing revenue account alarms service.
---	---

## REPORT DETAILS

<b>1.00</b>	<b>BACKGROUND TO THE SERVICE CHARGE REVIEW</b>
1.01	<p>The Council provides a range of services to residents, the community and visitors for which it can apply a fee or charge and generate income accordingly.</p> <p>Good practice suggests that local authorities should have a clear rationale for charging, which should include what services are charged for, how much is charged and how charging supports the delivery of corporate priorities.</p> <p>The Council's Income Generation policy (Appendix A) outlines the Council's rationale for fees and charges. It establishes the process by which fees and charges will be set and reviewed, sets out the key principles that should be used in setting them and outlines how charging for services supports the Council to deliver its corporate priorities.</p> <p>The Council's high-level aim is to maximise income generation wherever possible to contribute towards the delivery of key frontline services. Achieving full cost recovery for discretionary services, where the Council has a power but not a duty to provide the service, is a necessity for service sustainability. As, where the charge applied for these services does not cover the cost of service delivery, or it is not permitted to, this raises strategic questions for the Council to consider, such as if and how the services should be funded.</p>
	<b>Housing Revenue Account - Alarm Service Charge Review</b>
1.02	<p>Within the Council's housing stock (HRA) there are 2592 sheltered housing accommodation units. Following a review of the warden service in 2009 this service was ceased, and the Community Based Accommodation Service (CBASS) was created.</p> <p>The service provides a tenure neutral service for any older person in Flintshire who may need housing related support.</p> <p>In addition, the service provides a response service for alarm activations. For HRA residents this is a 24-hour service, operating an out of hours service from within the team for outside office hours (evenings, nights and weekends)</p>

1.03	<p>In 2015/2016 the Council introduced a service charge for this service as set out below:</p> <table border="1" data-bbox="320 241 1383 465"> <tr> <td data-bbox="320 241 863 315">Alarm Maintenance Charge</td> <td data-bbox="863 241 1383 315">£1.30 per week</td> </tr> <tr> <td data-bbox="320 315 863 389">Alarm Monitoring Charge</td> <td data-bbox="863 315 1383 389">£0.90 per week</td> </tr> <tr> <td data-bbox="320 389 863 465"><b>Total</b></td> <td data-bbox="863 389 1383 465"><b>£2.20 per week</b></td> </tr> </table>	Alarm Maintenance Charge	£1.30 per week	Alarm Monitoring Charge	£0.90 per week	<b>Total</b>	<b>£2.20 per week</b>
Alarm Maintenance Charge	£1.30 per week						
Alarm Monitoring Charge	£0.90 per week						
<b>Total</b>	<b>£2.20 per week</b>						
1.04	<p>As part of the consultation regarding the introduction of this new charge, some residents challenged this on the basis that they did not want, need, or use the alarm facility.</p> <p>Therefore, to address these concerns, and on a one off basis, the introduction of the new charge was only applied to those who required the alarm service, and others were given the opportunity to opt out of the service and not be charged.</p> <p>The opt out option only applied to this initial period to ease the transition to charges, this was not and is not offered to sheltered residents, any new residents to sheltered accommodation after this point, incur the service charge as part of their occupation contract (formerly the tenancy agreement)</p> <p>Any of the residents who opted out were given the option to opt back in at any stage if they required the alarm service and those that did, were and are charged for this service.</p> <p>There are currently 1846 residents with an active alarm and service charge.</p>						
Issues with Current Process							
1.05	The current service charge does not currently fulfil the requirement to achieve full cost recovery.						
1.06	<p>The current service charge is split as per the table at paragraph 1.03 above to support residents who are in receipt of means tested benefits to receive some support from the Housing Support Grant towards the cost of the alarm monitoring element (as this is not eligible for Housing Benefit or Universal Credit Housing element).</p> <p>This was originally intended to be in place for those residents who transitioned onto the charge in 2015/2016, however, this has never operated effectively due to the manual nature of the work and that people move on and off benefits, meaning charge adjustments at the point of change also.</p> <p>This has led to an inconsistent charging process which leaves the residents confused and a bigger gap between the charges and the costs. No exit strategy was developed for this process which has impacted the issues this causes.</p>						
Proposal for new service charges							
1.07	The table below details the breakdown of all the associated costs of providing this service. It also provides details of other funding that is used to						

	contribute to the overall costs, and how the balance that needs to be recovered from the service charge is calculated.		
1.08	<b>Alarm costs</b>	<b>Detail</b>	<b>Cost per annum</b>
	Maintenance cost	Contract with supplier (CHUBB)	£118,000
	Management cost	Staff costs 2 x FTE plus 25% manager	£118,000
	Equipment cost	Based on prior year spend for new equipment only (a recycle and reuse system operates where possible to keep the costs down)	£50,000
	Call monitoring contract	Call monitoring contract (Delta) £223,000 per annum includes non HRA alarms (total 3027)  Cost per customer £73.67 per annum x 1846 (HRA service) = £135,995 (rounded)	£135,995
	Out of hours alarm response service (HRA only service)	Cost 21/22 £35,775 Cost 22/23 £41,070  Cost (projected) 23/24 £39,529 (£23,059 to period 7)  Average cost to be applied to service charge £39,000	£39,000
	<b>Total ongoing cost 24/25</b>		<b>£460,995</b>
	Less the HRA contribution	This is an annual contribution to be reviewed as part of HRA business planning - management and equipment costs	£168,000
	<b>Total to be recovered via service charges</b>		<b>£292,995</b>
<b>Total service charge per resident</b>	<b>Total to be recovered £292,995 / 1846 sheltered residents with an alarm</b>	<b>£3.05 (£3.18 over 50 rent weeks)</b>	
1.09	The proposal is to apply the increased service charge to all sheltered residents who are currently using the alarm service. All new residents in sheltered schemes with an alarm will have the charge applied as per current process at the beginning of their new contract.		
1.10	In order that residents who are eligible for support with their housing costs are able to claim the maximum possible, we are proposing to apply the charge to the rent account in the following way:		
1.11	<b>Alarm costs</b>	<b>Detail</b>	<b>Charge over 50 rent weeks</b>
	Alarm	Maintenance contract (CHUBB)	£1.28

	maintenance charge (benefits eligible)	£118,000 per annum = £1.23 per week	
	Alarm monitoring charge	Call monitoring (Delta) £135,995 per annum Out of Hours Response £39,000 per annum Total £174,995 per annum = £1.82 per week	£1.90
	<b>Total</b>		<b>£3.18</b>
1.12	This proposal represents an increase of £0.85 per calendar week, or when calculating over a 50-week period it equates to £0.98 increase.		
1.13	This will achieve full cost recovery from 2024/2025 and can then be reviewed annually as part of the HRA business planning process to align costs to service charges moving forward.		

<b>2.00</b>	<b>RESOURCE IMPLICATIONS</b>
2.01	The proposed service charge increase will enable full cost recovery to be achieved.

<b>3.00</b>	<b>IMPACT ASSESSMENT AND RISK MANAGEMENT</b>
3.01	<p>Services should also take into consideration the following when reviewing and setting fees and charges:</p> <ul style="list-style-type: none"> <li>• Intelligence on the nature and elasticity of demand;</li> <li>• Benchmarking with other local authorities or alternative suppliers in more commercial markets;</li> <li>• An understanding of the market in which the service operates, including alternative service providers in the private, public and voluntary sectors;</li> <li>• Any applicable income targets for the service;</li> <li>• The implications of the level of fees and charges on the total income generated by the service, and the impact of this on the service and Council budget;</li> <li>• The impact of any increases on customers;</li> <li>• Whether concessions should be offered/continued, including : <ul style="list-style-type: none"> <li>○ The rationale for providing a concession to customers</li> <li>○ Evidence that the concession is promoting take up of the service and benefiting customers most in need and at risk</li> <li>○ The financial implications of offering concessions</li> </ul> </li> <li>• The Council's wider policy goals, aims and objectives;</li> <li>• The impact on communities; and</li> </ul>

	<ul style="list-style-type: none"> <li>• Equality and diversity issues.</li> </ul>
3.02	<p>To provide a comparison information on alarm service charges has been collated from two of our neighbouring authorities:</p> <ul style="list-style-type: none"> <li>• Wrexham - £5.65pw (£282.50 per annum)</li> <li>• Denbighshire - £3.92pw (196.00 per annum)</li> </ul> <p>Please note that neither of these includes the provision of an out of hours service response from the Local Authority.</p>

<b>4.00</b>	<b>CONSULTATIONS REQUIRED/CARRIED OUT</b>
4.01	Housing and Communities Programme Board
4.02	If the proposal is agreed, there will be a communication plan drafted to engage with the affected residents and local Members in the period leading up to the service charge implementation of April 2024.

<b>5.00</b>	<b>APPENDICES</b>
5.01	Flintshire County Council – Income Generation Policy

<b>6.00</b>	<b>LIST OF ACCESSIBLE BACKGROUND DOCUMENTS</b>
6.01	None

<b>7.00</b>	<b>CONTACT OFFICER DETAILS</b>
7.01	<p><b>Contact Officer:</b> Jen Griffiths – Service Manager, Housing; Welfare and Communities  <b>Telephone:</b> 01352 702929  <b>E-mail:</b> <a href="mailto:jen.griffiths@flintshire.gov.uk">jen.griffiths@flintshire.gov.uk</a></p>

<b>8.00</b>	<b>GLOSSARY OF TERMS</b>
8.01	None.



# Flintshire County Council

## Income Generation Policy

Version 3: June 2022

## Contents

<b>1</b>	<b>Approach and Objectives</b>	<b>2</b>
1.1	Approach	2
1.2	Objectives	3
<b>2</b>	<b>Principles</b>	<b>4</b>
<b>3</b>	<b>Process for reviewing and setting fees and charges</b>	<b>5</b>
3.1	Overview	5
3.2	Monitoring and governance	5
3.3	Approval of fees and charges	5
3.4	Process for annual review of fees and charges	6
3.5	Annual inflation uplift	7
3.6	Timescales and responsibilities	8
3.7	In year changes	8
3.8	New opportunities for income generation and the process for introducing new fees or charges	8
3.9	Communications	10
<b>4</b>	<b>Payments</b>	<b>11</b>
<b>5</b>	<b>Concessions</b>	<b>12</b>



# 1. Approach and Objectives

## 1.1 Approach

The Council provides a range of services to residents, the community and visitors for which it can apply a fee or charge and generate income accordingly.

Good practice suggests that local authorities should have a clear rationale for charging, which should include what services are charged for, how much is charged and how charging supports the delivery of corporate priorities<sup>1</sup>.

This policy outlines the Council's rationale for fees and charges. It establishes the process by which fees and charges will be set and reviewed, sets out the key principles that should be used in setting them and outlines how charging for services supports the Council to deliver its corporate priorities.

The Council's high level aim is to maximise income generation wherever possible to contribute towards the delivery of key frontline services. Achieving full cost recovery for discretionary services, where the Council has a power but not a duty to provide the service, is a necessity for service sustainability. As, where the charge applied for these services does not cover the cost of service delivery, or it is not permitted to, this raises strategic questions for the Council to consider, such as if and how the services should be funded.

The setting of fees and charges must be linked to the Council's annual budget planning and Medium Term Financial Strategy (MTFS) planning process to create a strategic and coherent approach.

Any approach to income generation will by necessity need to be flexible, as this is a complex area and maximising income generation is not just about increasing fees and charges. For example, increasing fees/charges for services that operate in a commercial market to above the market rate may reduce demand for services, negatively impacting on income. Raising fees/charges to a level where customers can no longer afford them is likely to have a similar effect. Therefore, in some instances, it may be more appropriate to reduce fees and charges to gain a greater share of the market.

The Council may choose to offer subsidies to promote access to services for those who otherwise could not afford them. Such subsidies (often referred to as concessions) must

---

<sup>1</sup> Wales Audit Office (2016) Charging for services and generating income by local authorities. Available from: <https://www.audit.wales/system/files/publications/income-generation-2016-eng.pdf>

be transparent, properly understood and have a clear rationale, as each time a service user is not paying the full cost of a service, the council tax payer is providing a subsidy.

By strategically using charging and concessions, the Council can influence the behaviour of residents in line with wider Council policy goals. The Council can also demonstrate the value of its services and discourage the abuse of such services.

This policy document aims to support Council Members and Officers to strike the appropriate balance between these conflicting pressures and priorities.

## **1.2 Objectives**

The objectives of this policy are to ensure that the Council:

- Maximises revenue generation through full cost recovery wherever possible;
- Ensures that a clear and consistent set of principles and criteria underpin all decision making;
- Ensures that fees and charges are set in a way that complements the Council's wider policy goals;
- Sets prices as part of the approach to marketing the service, setting fees and charges that are comparable with our own and/or broader commercial market and which reflect the ability of customers to pay for them;
- Adopts differential pricing for some specific services where warranted;
- Puts in place a consistent process and governance structures;
- Takes into account any competition to deliver the service from the public, private or voluntary/third sectors; and
- Collects payment of fees and charges as efficiently as possible, utilising digital mechanisms and in advance of the point of delivery where possible whilst providing alternative options for customers to make payment where needed.

## 2. Principles

This section sets out the overarching principles that should be applied when setting fees and charges across the Council.

Flintshire County Council's fees and charges should:

- Maximise the level of income generated from the service within the appropriate legal framework that governs those fees/charges;
- Ensure charges are transparent and communicated to customers with reasonable notice;
- Take into account the nature of demand for the service and any market intelligence available;
- Complement the Council's wider policy goals and objectives;
- Be reviewed annually, overseen by Programme Boards, and reported to Cabinet in July of each year prior to implementation of any changes on 1<sup>st</sup> October;
- Achieve full cost recovery or market rate comparison wherever possible, with a phased approach to achieving by October 2022 for those not already operating at full cost recovery;
- As a minimum increase in line with inflation each year, where permitted, using one of the agreed inflation indices, unless there is a clear rationale for not doing so, or for reducing the level of the fee in real terms; and
- Take into account equality and diversity issues.

It is acknowledged that a number of these principles are contradictory in nature and that there should be a clear mechanism for deciding the prevailing priorities for each instance where conflicts arise.

### **3. Process for reviewing and setting fees and charges**

#### **3.1 Overview**

This section of the policy sets out the process for the setting of fees and charges across the Council. It aims to put in place a transparent process that will take place annually, ensuring that all areas of the Council are taking into account the same principles and criteria in making decisions on the level of fees and charges.

#### **3.2 Monitoring and governance**

A governance and oversight structure is required to standardise the process of setting fees and charges and ensure that service areas are consistently basing their decisions on the appropriate criteria. For this purpose income generation will be monitored through current portfolio Programme Boards and the annual review of fees and charges reported to Cabinet in July each year prior to any changes being implemented on 1<sup>st</sup> October.

Changes to fees and charges at other times during the year can be made in some circumstances, such as statutory fee changes, which are set by government/in legislation and in other extenuating circumstances.

In relation to income management Programme Boards will:

- Receive proposals for adjusting fees and charges on an annual basis, which must be considered in light of the Council's overarching MTFS;
- Review income related business case investment proposals and proposals to introduce new fees or charges;
- Review these proposals to ensure that the appropriate criteria underpin the proposals;
- Recommend the appropriate process for approval for new fees/charges and changes to existing fees/charges where changes are not aligned to the agreed process and principles outlined in this policy and accompanying guidance; and
- Monitor the income generation performance of services against set targets.

#### **3.3 Approval of fees and charges**

Programme Boards do not have the authority to approve the setting of fees and charges. The responsibility for this remains with individual Chief Officers in consultation with their respective Cabinet Member under delegated powers/authority and/or Cabinet or Full Council, where necessary.

### **3.4 Process for annual review of fees and charges**

#### ***Step 1***

Fees and charges should be reviewed annually and this review will commence in April each year, instigated and overseen by the Council's Corporate Finance Team. Service areas will be required to review current levels of fees and charges for all chargeable services.

When reviewing and setting fees and charges the service should ensure it understands the full cost of providing the service, including overheads (indirect costs), and the demand for the service. Services should be prepared to provide supporting information to demonstrate full cost recovery or market rate comparison is being achieved, where permitted.

Services should also take into consideration the following when reviewing and setting fees and charges:

- Intelligence on the nature and elasticity of demand;
- Benchmarking with other local authorities or alternative suppliers in more commercial markets;
- An understanding of the market in which the service operates, including alternative service providers in the private, public and voluntary sectors;
- Any applicable income targets for the service;
- The implications of the level of fees and charges on the total income generated by the service, and the impact of this on the service and Council budget;
- The impact of any increases on customers;
- Whether concessions should be offered/continued, including :
  - The rationale for providing a concession to customers
  - Evidence that the concession is promoting take up of the service and benefiting customers most in need and at risk
  - The financial implications of offering concessions
- The Council's wider policy goals, aims and objectives;
- The impact on communities; and
- Equality and diversity issues.

## **Step 2**

Having reviewed and updated their fees and charges accordingly, service areas will need to report these to their Programme Board.

The Programme Board will assess whether the right balance between competing interests has been struck given the wider financial context and will advise the service area on any changes that may be required. The Programme Board will also determine whether the proposals should be sent for approval. In particular the Programme Board will expect that:

- As a minimum the value of fees and charges should be maintained in real terms over time and increased annually in line with one of the agreed inflation indices;
- Any discretionary services that are not achieving full cost recovery will explain why they are operating at a deficit and more importantly how they will achieve full cost recovery with an accompanying plan for doing so; and
- All concessions will be justified, with evidence that the concession is benefitting the target community and the financial implications of the concession for the wider service budget made clear.

## **Step 3**

When proposals have been supported in principle by the Programme Board they can be returned to Corporate Finance who will collate returns from service areas/Portfolios.

The output of this review will be a collated schedule of all fees and charges applied by the Council which will be reported to Cabinet in July for approval prior to any changes being implemented on 1<sup>st</sup> October.

Changes to fees and charges at other times of the year are permitted for statutory fee changes and under other extenuating circumstances. However, the processes, principles and approvals outlined in this policy should still be followed and adhered.

Estimates of additional income from increases to fees and charges should be passed to Corporate Finance, agreed and factored into the final budget setting process/MTFS.

Further information and supporting guidance for the annual review of fees and charges will be circulated to service areas at commencement of the annual review.

### **3.5 Annual inflation uplift**

The normative annual inflation index to be used as part of the annual review of fees and charges is the Consumer Prices Index, including owner occupiers' housing costs (CPIH) 12 month inflation rate, as of March in the calendar year of the review. However, the local or Council's inflation rate, which requires a calculation of the annual increases in

direct and indirect costs for each service where a fee/charge is applied, or a market rate comparison inflation rate can be used.

Where the Council has the power to alter fees and charges it is assumed that one of these inflation indices will be used to apply an annual inflation uplift.

### **3.6 Timescales and responsibilities**

The annual review of fees and charges will commence in April each year, instigated by Corporate Finance.

Service areas/Portfolios will be responsible for reviewing their fees and charges in consultation with their Principal Accountant and for submitting these to Programme Boards for consideration, in line with the process detailed in this policy.

Portfolios should return their fees and charges to Corporate Finance by late May/early June. Corporate Finance will then collate the schedule of fees and charges ready to circulate to Cabinet, with an accompanying report, for approval at their July meeting.

Any changes to fees and charges resulting from the annual review will be implemented on 1<sup>st</sup> October, allowing adequate time for service areas to communicate changes to customers and other stakeholders in advance of their implementation.

Service areas are responsible for setting any new fees and charges, ensuring these fully recover costs wherever permitted, apply VAT where applicable and go through the appropriate approval processes, as detailed in this policy.

Where there are identified areas of non-compliance with the above responsibilities, Principal Accountants within Corporate Finance can escalate any identified non-compliance to the appropriate Chief Officer.

Roles and responsibilities in relation to fees and charges are summarised in the following table.

<b>Role</b>	<b>Responsibility</b>
Annual review of fees and charges, ensuring compliance with relevant regulation/legislation as applicable to those fees and charges and the Council's Income Generation Policy	Service areas/Portfolios
Developing proposals/business cases for new fees and charges, ensuring compliance with relevant regulation/legislation as applicable to those fees and charges and the Council's Income Generation Policy	Service areas/Portfolios

To provide checks of calculations, highlight inaccuracies and to raise to service areas any identified non-compliance with Policy	Management Accounting Team (Principal Accountants)
Resolution of any identified non-compliance	Service areas/Portfolios
Authority to approve fees and charges	Chief Officers in consultation with the appropriate Cabinet Member; or Cabinet; or Full Council
Monitoring income generation, including proposals for adjusting fees and charges	Portfolio Programme Boards (as outlined in sections 3.2 and 3.4 of this Policy)
Instigation of the annual review of fees and charges, to include producing draft schedule of fees and charges for review and supporting guidance/documents	Corporate Finance
Collation of annual schedule of fees and charges and reporting to Cabinet	Corporate Finance
Notifying customers (or potential customers) of fees and charges and/or changes to these	Service areas/Portfolios

**3.7 In year changes**

As noted earlier in this policy, the Council’s Constitution provides Chief Officers, in conjunction with their respective Portfolio Cabinet Members, a mechanism to set fees and charges in accordance with any policy or strategy approved by the Cabinet or Council, i.e. this policy.

With prior approval charges can be varied on an in year basis, i.e. to manage demand as part of demand management, or ensure costs are fully recovered if these increase significantly in year.

**3.8 New opportunities for income generation and the process for introducing new fees or charges**

Each year the Members, Chief Officers and Service Managers from across the Council should actively consider new opportunities for income generation. However, this process should not simply be viewed as an annual activity and opportunities to generate additional income should be explored proactively throughout the year.

The purpose of these reviews should be to go beyond the usual paradigms of service delivery and create a more commercial culture within the organisation testing the boundaries of what is possible and exploring new ideas. They should discuss individual services in turn, assess latest development and best practice in income generation nationally, consider new ideas, and establish whether any can be taken forward.



If ideas are identified Chief Officers and Service Managers will be tasked with their exploration, development and implementation.

The process and considerations for introducing any associated new fees or charges is broadly the same as that for the review of fees and charges outlined in section 3.4 above. That is fees and charges should be set to achieve full cost recovery and the Council has developed a cost recovery template to assist service areas with this. In addition, intelligence should be gathered about anticipated demand and the market more broadly to understand the market in which the service will operate, benchmarking against other local authorities and/or the wider market should be undertaken, and the ability of customers to pay, including the use of concession should be considered, alongside the fit with the Council's wider policy goals, aims and objectives. An Integrated Impact Assessment (IIA) should also be completed for any new fees/charges, which will incorporate considerations around equality and diversity issues.

Service areas should seek support from their Principal Accountant when looking to calculate new fees and charges and should seek advice regarding the VAT status of any new proposed fees or charges, i.e. if they are standard rated, exempt, etc.

As outlined in section 3.2 above, Programme Boards should consider any proposals for new fees and charges. When agreement in principle is sought from Programme Boards, the Board will recommend whether the proposals should be sent for approval under the process of delegated powers/authority.

The following principles and guidelines will apply here:

- The presumption should be that the proposal will be sent for approval under delegated powers as outlined in the Council's Constitution.
- If the proposal raises concerns that it will be politically controversial, it should, in the first instance, be referred to the Cabinet Member with responsibility for the service in conjunction with the Chief Officer for further consideration and approval, who may choose subsequently to refer to Cabinet for approval.

All proposals will be sent for approval using the methods supported by the Programme Board and, if approved, will be enacted by services.

Estimates of additional income from the introduction of new fees and charges should be passed to Corporate Finance, agreed and factored into the final budget setting process/MTFS.

### **3.9 Communications**

The schedule of fees and charges resulting from the annual review will be published. However, service areas should put in place arrangements to communicate clearly any changes in fees and charges, or the introduction of new fees/charges, to customers.

A segmented approach should be used to ensure that the right messages are communicated to the right stakeholders, which should include, where applicable:

- Council staff;
- Customers/service users’;
- Taxpayers;
- The media;
- Local businesses; and
- Community groups.

A corporate approach will be taken to managing and approving these communications, where considered necessary, in order to ensure consistency of message across the Council. This approach will include the following principles:

- All communications issued should make clear the reason for the change in the fee or charges (e.g. in line with inflation, increases costs, etc.);
- Where there is an increased fee or charge, communications should provide clear advice to customers on the concessions available (if any) to make sure those who are entitled to discounts receive them; and
- The timing of communications should be co-ordinated in line with when the change is implemented.

Any communications proposed to be issued out in respect to this should be cleared by the respective Portfolio Cabinet Member before being sent.

## **4. Payments**

It is vital that the Council receives payment for its chargeable services. Wherever possible customers should be required to pay charges in advance of delivery of services, or at the point of delivery, to minimise the risk of non-payment and to assist customers to manage their own liabilities to the Council.

To facilitate payment, and provide a customer centred service, multiple payment methods should be available to the customer. However, online and direct debits should be promoted as preferred methods.

Each year a review should also be undertaken of the means by which payments are made to all services. As part of the annual review of fees and charges, and when setting new fees and charges, services should consider how payment is collected and how this can be made (more) efficient, using less expensive channels of payment collection and how this will be promoted and signposted to. This work should be consistent with the objectives set out in within the Council's Digital Strategy.

## 5. Concessions

A concession is applied when a local authority chooses to set a charge below the actual cost of service provision.

Concession setting is a careful balancing act. The Council may wish to target certain services at a specific group of residents and in doing so it may decide to apply a concession. For example, it may wish to offer assistance to the elderly, or those on benefits. However, every time a customer is not paying the full cost of a service, the council tax payer is in effect providing a subsidy. It is therefore important that efforts are made to ensure that subsidies are targeted at those customers whom the Council has made a conscious policy decision to help.

Certain principles are therefore important when determining the need for a concession:

- The Council should be wary of extending concessions to those who may be able or willing to pay the full fee/charge for a service;
- Concessions should not be applied to services which are lower priority for the Council;
- Concessions should be focused on those groups most in need and at risk;
- Concessions must be transparent, properly understood and have a clear rationale for their application;
- The implications of each concession for the Council's overall financial position must be understood;
- There should be evidence that the concession is promoting take up of the service and benefitting customers; and
- Concessions should be non-discriminatory in nature and effect.

Concessions are likely to exist on a service specific level. It is therefore important that when reviewing concessions a consistent approach has been taken. Programme Boards will undertake this role as a part of the process outlined in section 3 of this policy, along with an assessment of whether services proposals for concessions should be supported.

In order to this the Board will:

- Collect information available on subsidies provided for chargeable services;

- Ask finance staff to map the overall financial consequences of current subsidies for the Council's budget;
- Assess the information provided by service areas and consider the financial consequences for the Council's budget submitted by finance. The Board's presumption will be that all concessions need to be justified, and the financial implications of the concession for the wider service budget must be clear;
- As part of this process the Board should compare the need for and cost of subsidies that exist in different services. To do this the Board should rate the chargeable services prioritising who should pay for the service by asking the following questions:
  - Should the council tax payer pay for the services? (in which case the service is free to customers/service users)
  - Or should the service user pay for the service? (in which case there will be no subsidy and the customer will pay the full cost of the service)
  - How much will each of these options cost the taxpayer?

Based on the above, the Board can decide which service proposals and subsidies should be approved. This process will enable the prioritisation of subsidies within a clear financial context, to feed into the Board's decision as to whether to send service proposals for approval.

The Council will undertake this process on an annual cycle.

Mae'r dudalen hon yn wag yn bwrpasol

# Eitem ar gyfer y Rhaglen 13



## CABINET

<b>Date of Meeting</b>	Tuesday 16 <sup>th</sup> January 2024
<b>Report Subject</b>	Housing Management and Anti-Social Behaviour Policy
<b>Cabinet Member</b>	Cabinet Member for Housing and Regeneration
<b>Report Author</b>	Chief Officer (Housing and Communities)
<b>Type of Report</b>	Strategic

### EXECUTIVE SUMMARY

The Council is committed to providing an effective and efficient housing management service that reflects best practice, complies with legislation and protects the rights of contract holders as well as minimising risk to the Council for not complying with appropriate legislation.

The Renting Homes (Wales) Act 2016, which came into effect from the 1<sup>st</sup> December 2022, is the biggest change to housing law in Wales for decades. The new legislation has changed the way all landlords in Wales rent their properties.

The Renting Homes (Wales) Act 2016 aims to simplify the process of renting a home in Wales and to provide parties with more information about their rights and obligations. The Act is now partially in force, for the purpose of making regulations and issuing guidance.

The implementation of the significant changes brought about by the Act, has made it necessary to review and draft revised policies and procedures.

The report provides an overview of the changes that have been made to the Housing Management Policy and the Anti-Social Behaviour Policy

### RECOMMENDATIONS

1	To approve the Housing Management and Anti-Social Behaviour policies.
---	---

## REPORT DETAILS

<b>1.00</b>	<b>HOUSING MANAGEMENT POLICY (appendix 1)</b>
1.01	The Council is committed to providing an effective and efficient housing management service that reflects best practice, complies with legislation and protects the rights of contract holders as well as minimising risk to the Council for not complying with appropriate legislation.
1.02	The Renting Homes (Wales) Act 2016, which came into effect from the 1 <sup>st</sup> December 2022 is the biggest change to housing law in Wales for decades. The new legislation has and will change the way all landlords in Wales rent their properties.
1.03	The Renting Homes (Wales) Act 2016 aims to simplify the process of renting a home in Wales and to provide parties with more information about their rights and obligations. The Act is now partially in force, for the purpose of making regulations and issuing guidance.
1.04	<p>Some of the key changes in the Act reflected in the updated policy are changes to tenancy agreements. These have been replaced by occupation contracts and tenants are now referred to as contract holders.</p> <ul style="list-style-type: none"> <li>• Tenancy Agreement &gt; Occupation Contracts</li> <li>• Tenants and Licensees &gt; Contract Holders</li> </ul> <p>Contracts will fall into two types - 'Secure' for the social rented sector and 'Standard' for the private rented sector.</p>
1.05	<p>Within occupation contracts there will be four types of terms feature within them:</p> <p><b>Key matters:</b> The names of the parties and address of the property. These must be inserted in every contract.</p> <p><b>Fundamental Terms:</b> Cover the most important aspects of the contract, including the possession procedures and the landlord's obligations regarding repair.</p> <p><b>Supplementary Terms:</b> Deal with the more practical, day to day matters applying to the occupation contract, for example, the requirement for a contract holder to notify the landlord if the property is going to be empty for four weeks or more.</p> <p><b>Additional Terms:</b> Addresses any other specifically agreed matters, for example a term which relates to the keeping of pets.</p>
1.06	There remains some difference in treatment for private landlords and social landlords, though the distinction between local authority and housing association landlords is largely gone – they are all now 'community landlords' and treated the same. Community landlords will usually have to give secure contracts and private landlords will usually give standard ones.
1.07	Other key changes are in relation to the increased security for contract



	<p>holders as eviction notice periods have increased from two months to six months, as long as the contract has not been breached.</p> <p>However, for landlords, the changes in law also mean that it will be easier to repossess abandoned properties, without needing a court order.</p> <p>In relation to property safety standards, all landlords should ensure homes are fit for human habitation this includes working smoke alarms, carbon monoxide detectors and electrical safety testing.</p>
1.08	In relation to the Housing Management Policy, a summary of the main changes are as follows:
1.09	<p><b>Adding and removing contract holders</b></p> <p>New procedures will now allow for some occupiers to leave without prejudicing the others. This simplifies the process in cases of domestic abuse, or where there is a relationship break down and one person wishes to remain in the property.</p> <p>One contract holder will no longer be able to end the agreement for everyone else without their consent, a notice seeking to do so will only bind themselves.</p> <p>Whilst landlords will still have some control over people being added or removed from the contract, they will have to act reasonably (whether in withholding consent or imposing conditions), and unreasonable actions can be directly challenged in Court.</p>
1.10	<p><b>Abandonment</b></p> <p>The process of excluding an absent contract holder is now significantly easier whether against a sole or joint contract holder.</p> <p>A landlord can do so without a Court order and one joint contract holder can exclude another by an application to the Court.</p> <p>There will always be a mandatory investigation period and opportunity to challenge the outcome, but new strict deadlines will ensure that properties are not left unoccupied for lengthy periods.</p>
1.11	<p><b>Succession rights</b></p> <p>These are considerably enhanced in many cases. Most notably, survivorship falls outside of the succession rules, which has previously created real difficulties when children have been unable to succeed to a tenancy after the death of both parents.</p> <p>There will also in many cases be two opportunities to succeed to a contract following the death of sole contract holders – first from a spouse, civil partner or similar relation, if there is one, and then to other close family members.</p>

	<p>As independent living has become increasingly more difficult for many young people still living at home (whether by rising rents or inability to buy), this will be a welcome development in creating secure long-term living conditions for families in the rental sector.</p>
<p><b>ANTI-SOCIAL BEHAVIOUR POLICY (appendix 2)</b></p>	
1.12	<p>The Council is committed to tackling anti-social behaviour as we know it has a devastating impact on the lives of our customers. The policy needs to reflect best practice and protect the rights of contract holders as well as minimising risk to the Council for not complying with appropriate legislation.</p> <p>The aim of the policy is to ensure that effective systems are adopted to prevent and minimise instances of anti-social behaviour and to resolve them as early as possible through timely and appropriate intervention.</p>
1.13	<p>Anti-social behaviour covers the range of behaviours from low-level nuisance to serious harassment, which can damage the quality of life and interfere with the ability of people to use and enjoy their home and/or community.</p>
1.14	<p>All low-level anti-social behaviour, general neighbour disputes, noise etc., are dealt with by Neighbourhood Housing Officers, however, should a breach of tenancy be determined the case is escalated to Tenancy Enforcement Officers for enforcement action. A dedicated Tenancy Enforcement team deal with all high-level cases. This includes drugs, assault, anything deemed to be personal harm following a risk assessment and other tenancy breaches which cannot be resolved by the relevant neighbourhood officer.</p>
1.15	<p>Flintshire County Council is committed to preventing incidents of anti-social behaviour occurring in the first instance and will use a range of preventative actions to achieve this. Where incidents have occurred, we recognise that early intervention is the key to avoid escalation. However, we will take legal action to resolve the situation if it is deemed necessary and appropriate.</p>
1.16	<p>The occupation contract clearly sets out the obligations of contract holders and contains a number of clauses which can be relied upon when dealing with complaints of anti-social behaviour. The contracts make it clear that contract holders are responsible for the behaviour of everyone (including children) living in or visiting their home.</p>
1.17	<p>The Council will take a victim centred approach, taking action quickly, decisively and using a harm/risk-based approach. Dealing with all matters professionally and sensitively placing a strong emphasis on early intervention and positive communication. As a landlord we may work with other agencies, such as the police to take any appropriate action.</p>
1.18	<p>The Anti-Social Behaviour Policy contains a number of sections which</p>

	<p>explain the following:</p> <ul style="list-style-type: none"> <li>• Definition of anti-social behaviour</li> <li>• General Policy Statement on Anti-Social Behaviour</li> <li>• Strategic and Legislative Context</li> <li>• Preventing Anti-Social Behaviour and Nuisance</li> <li>• Tenant and Landlord Responsibilities</li> <li>• Tackling Anti-Social Behaviour</li> <li>• Victim Centred Approach</li> </ul>
1.19	<p><b>Definition of Anti-Social Behaviour</b></p> <p>Chapters 7, Section 55 of the Renting Homes Wales Act [2016] covers anti-social behaviour and other prohibited conduct and states clearly what is prohibited conduct.</p> <p><i>Additionally, Section 2 of the Anti-Social Behaviour, Crime and Policing Act 2014 defines anti-social behaviour as:</i></p> <p><i>(a) Conduct that has caused, or is likely to cause, harassment, alarm or distress to any person,</i></p> <p><i>(b) Conduct capable of causing nuisance or annoyance to a person in relation to that person's occupation of residential premises, or</i></p> <p><i>(c) Conduct capable of causing housing-related nuisance or annoyance to any person.</i></p> <p>In simple terms, it can be defined as behaviour causing harassment, alarm or distress to members or any member of the public.</p>
1.20	<p>Anti-Social behaviour <b>can</b> include the following examples:</p> <ul style="list-style-type: none"> <li>• Drug related offences.</li> <li>• Violence or threats of violence and actual assault.</li> <li>• Intimidation and harassment.</li> <li>• Aggressive and threatening language and behaviour.</li> <li>• Hate crime or behaviour.</li> <li>• Noise and other neighbour nuisance.</li> <li>• Local environmental quality issues such as fly-tipping, vandalism and graffiti.</li> <li>• Illegal or immoral use of residential premises.</li> </ul>
1.21	<p>The Council recognises that the term anti-social behaviour can and does mean different things to different people, and what might appear to be acceptable behaviour for one resident, may not be acceptable to another.</p>
1.22	<p>It is also recognised that such behaviour may happen over a sustained and/or long period of time, making life very difficult for residents, or there might be one very serious incident of anti-social behaviour which requires immediate intervention.</p>
1.23	<p>Not every complaint received will constitute anti-social behaviour and where this is the case no further action will be taken but appropriate advice</p>

	<p>and guidance will be given to the person reporting. This can be subject to review if there is a change or escalation in the circumstances.</p> <p>Anti-social behaviour is not:</p> <ul style="list-style-type: none"> <li>• Children playing in the street or local parks.</li> <li>• Young people gathering socially.</li> <li>• Being unable to park outside your home.</li> <li>• One off parties / celebrations</li> <li>• DIY works at reasonable hours etc.</li> </ul>
1.24	The policy focuses on tackling anti-social behaviour that either affects, or is carried out by, people living within our properties and our neighbourhoods. This includes contract holders and complainants, their family members (including children) or friends, owner-occupiers, lodgers or private contract holders.
1.25	The intentions of the person/s carrying out the behaviour will also be taken into account, as well as any disability and/or support needs they may have. It is important to state that anti-social behaviour will not be tolerated.

<b>2.00</b>	<b>RESOURCE IMPLICATIONS</b>
2.01	None

<b>3.00</b>	<b>IMPACT ASSESSMENT AND RISK MANAGEMENT</b>				
3.01	<p>If the Council does not provide a robust and efficient service in managing its estates, then the housing service will be at risk of:</p> <ul style="list-style-type: none"> <li>• Long term voids.</li> <li>• Increase in anti-social behaviour.</li> <li>• An increase in litigation.</li> <li>• Poor reputation.</li> <li>• Having inadequate resources.</li> </ul> <p>Anti-social behaviour can be a destructive force within communities and the lives of a significant number of people within those communities can be negatively affected by the behaviour of an unreasonable minority.</p> <p>Anti-social behaviour can also damage the sustainability of communities and adversely affect the Council's ability to let our properties.</p> <p><b>Ways of Working (Sustainable Development) Principles Impact</b></p> <table border="1"> <tr> <td>Long-term</td> <td>Positive – Providing sustainable tenancies in safer, cleaner neighbourhoods.</td> </tr> <tr> <td>Prevention</td> <td>Positive - Preventing homelessness</td> </tr> </table>	Long-term	Positive – Providing sustainable tenancies in safer, cleaner neighbourhoods.	Prevention	Positive - Preventing homelessness
Long-term	Positive – Providing sustainable tenancies in safer, cleaner neighbourhoods.				
Prevention	Positive - Preventing homelessness				

		through ensuring there is adequate support and accommodation to cater for a range of needs.
	Integration	Positive – Increased integration between services and partner organisations.
	Collaboration	Positive – Increased collaboration between services and partner organisations.
	Involvement	Positive – Customer involvement to help shape effective services so that support is timely and person centred
<b>Well-being Goals Impact</b>		
	Prosperous Wales	Positive – providing good quality and affordable homes
	Resilient Wales	Positive – Creating services that are prevention focused and build resilience to avoid households becoming homeless specifically vulnerable persons
	Healthier Wales	Positive – Reduction in homelessness and increase in targeted support for mental health
	More equal Wales	Housing service is delivered in a way that is inclusive for all
	Cohesive Wales	Positive – Safer and well-connected neighbourhoods
	Vibrant Wales	Positive – encourages residents to be more involved in their community
	Globally responsible Wales	Neutral

<b>4.00</b>	<b>CONSULTATIONS REQUIRED/CARRIED OUT</b>
4.01	<p>Consultation has been completed and included:</p> <ul style="list-style-type: none"> <li>• Draft policy shared with residents' groups and the Tenants Federation.</li> <li>• Attendance at resident group meetings.</li> <li>• Other groups as identified following the first stage Integrated Impact Assessment.</li> <li>• Cabinet and Communities and Housing Overview and Scrutiny</li> </ul>

	Committee.
--	------------

<b>5.00</b>	<b>APPENDICES</b>
5.01	Housing Management Policy 2023
5.02	Anti-Social Behaviour Policy 2023

<b>6.00</b>	<b>LIST OF ACCESSIBLE BACKGROUND DOCUMENTS</b>
6.01	<a href="https://www.gov.wales/housing-law-changed-renting-homes">https://www.gov.wales/housing-law-changed-renting-homes</a>

<b>7.00</b>	<b>CONTACT OFFICER DETAILS</b>
7.01	<b>Contact Officer:</b> Jen Griffiths – Service Manager, Housing; Welfare and Communities <b>Telephone:</b> 01352 702929 <b>E-mail:</b> jen.griffiths@flintshire.gov.uk

<b>8.00</b>	<b>GLOSSARY OF TERMS</b>
8.01	<b>Anti-Social Behaviour</b> - behaviour causing harassment, alarm or distress to members or any member of the public.



## **Housing Management Policy 2023**

# HOUSING & COMMUNITIES

---

## 1. MANAGEMENT INFORMATION

Date Policy approved by FCC Cabinet / Scrutiny	
Replacing / Updating	Tenancy Management Policy 2020
Next Review Date	April 2026
Drafted By:	Dawn Kent
Responsible Senior Officer	Vicky Clark
Circulation list	Available to all FCC staff via Shared Drive



# HOUSING & COMMUNITIES

---

## 1.0 Policy Statement

Flintshire County Council (otherwise referred to as “the Council”) is committed to providing an effective and efficient Housing Management service that reflects best practice, complies with legislation and protects the rights of contract holders as well as minimising risk to the Council for not complying with appropriate legislation.

FCC Neighbourhood, Tenant Sustainment and Tenancy Enforcement teams will ensure that information can be provided in appropriate formats, explaining to contract holders their roles and responsibilities under the contract agreement they have signed. We will provide leaflets and advice in both written and verbal form to our contract holders to ensure they have all the information they need to ensure they are able to keep to the terms of the agreement and sustain their occupation contracts.

A full suite of procedures have been developed and are available to the Housing Management team.

We will establish service standards and Key Performance Indicators in respect of the Housing Management Service so that our contract holders know what level of service they can expect from us and against which we will monitor our performance.

## 2.0 Allocations

The major social landlords operating in Conwy, Denbighshire and Flintshire have come together, with the Local Authorities, to form a Partnership to manage applications for and allocations of social housing. The partners in the scheme are:

- Conwy County Borough Council
- Denbighshire County Council
- Flintshire County Council
- Cartrefi Conwy
- North Wales Housing Association
- Grwp Cynefin
- Wales and West Housing Association
- Clwyd Alyn Housing Limited

All partners agree that there is a high demand for rented homes in the region and too few vacancies to meet demand. We must be realistic about this. It requires us to do two things:

Firstly, we will provide the best, most useful, consistent and accessible advice and information to everyone who comes to us looking for housing. We aim to help customers make the most informed choice about how to find a home to meet their

## HOUSING & COMMUNITIES

---

needs. This advice must cover the whole range of affordable housing options, including social housing, private rented accommodation, home ownership and other alternatives.

Secondly, we will allocate our housing stock in a transparent, fair, consistent and accessible way, which prioritises the people in our communities according to their housing needs and which meets our legal requirements.

Working together to these ends, we can share our strengths and good practice and place the customer at the heart of everything we do. We will simplify the access route to advice and to housing with one clear purpose: to help people find a home to meet their needs.

### **3.0 Rent Income Management**

Each year rent is reviewed for all Contract Holders. The rent which is received is used to pay for the services to maintain council properties, carry out repairs and undertake property improvements as part of the Council's priority to modernise council homes.

A Tenancy Charge letter is issued to Contract Holders at commencement and every year thereafter with a breakdown of rent and other charges.

A rent account statement is issued to all Contract Holders every 3 months and on request, showing an up-to-date account balance.

The way in which the council calculate rent increases is determined by a Welsh Government formula. Contract Holders will be issued with written notification at least two months prior to a change in their basic rent taking affect.

The council operates two non- collection weeks which is shown on the tenancy charge letter. If a Contract Holder is behind with their rent or other charges the non-collection weeks do not apply and they must pay any rent or other charges during these weeks.

# HOUSING & COMMUNITIES

---

## 4.0 Pre-contract Assessments

The council recognises the importance of ensuring contract holders are able to sustain their contracts. The current economic climate presents a tough and challenging outlook for many contract holders. Although it is recognised that contract holders may be affected in different way they are all susceptible to the potential impact at any time during the term of their contract as it only takes a loss of a job, change in benefits to substantially change circumstances and create a need for advice and support.

Before any contract commences, a pre-contract assessment is carried out with a focus on:

- affordability assessments that include all the costs with managing a home.
- allocating the most suitable type of property – for example, where a contract holder has a disability, ensuring the property is suitable for their needs.
- undertaking verification checks on a contract-holder's identification, immigration status, circumstances and contract history (this will include former landlord references).
- checking with other housing providers for former contract holder arrears/incidents of ASB.
- making timely and appropriate referrals to support services.

Contract holders who have been assessed as requiring further support will be offered and provided with sustainment visits to ensure that they are equipped with the appropriate skills, knowledge and resources to successfully manage the contract.

## 4.1 Types of Contract

This Policy document will concentrate on the Housing Management function of the service and will also cover how new and existing contract agreements will be managed. There is one type of contract entered into with the council, in the majority of cases namely: secure.

## 4.2 Secure Occupation Contracts

Under Renting Homes (Wales) Act 2016 (the Act) legislation secure contract holders have a number of rights, some of which may be subject to the council's consent.

These rights include:

## HOUSING & COMMUNITIES

---

- To be supplied with a written statement of the contract within 14 days of the Occupation Date. If the identity of the contract holder changes, the council must give the new contract holder a written statement within 14 days of the change (or of the day on which the council became aware of the change) Other information and documents must also be given at the onset or within the first 14 days of the contract.
- To be given any notice, statement or other document required or authorised to be given or made either by an occupation contract under the Act, in writing. Electronic service is permissible if the contract holder has indicated they are willing to receive the document electronically.
- That the property is fit for human habitation
- A joint contract holder will be able to leave the contract without ending the contract entirely.
- Live in the property - no contract holder can be made to leave their home unless ordered to do so by a court.
- Pass on the contract upon death, provided certain conditions are satisfied. The Act allows two successions to a contract to take place.
- Take in lodgers provided you do not overcrowd your home.
- Sublet part of the home.
- New contract holders will be able to be added without having to end the current contract.
- To transfer the contract to a potential successor.
- To transfer the contract to another secure contract holder
- To be consulted on any changes to their contract.
- If they report behaviour which is classed as prohibited conduct under the Renting Homes (Wales) Act 2016 on the part of anyone living in a property belonging to us, including property occupied by the person reporting, we must give appropriate advice. – there is a separate policy document and accompanying procedure to cover this in further detail.

### **4.3 Terminating a Contract**

The contract holders may end an occupation contract by giving not less than four weeks' notice to the council. We will manage the process within the defined legislation. (Renting Homes Wales Act 2016, s163)

### **4.4 Successions**

In the event of the death of a contract holder, we are committed to dealing with requests to succeed contracts as quickly and sensitively as possible. We will manage the process within the defined legislation. (Renting Homes Wales Act 2016, s74 -83)

## HOUSING & COMMUNITIES

---

### **4.5 Transfers to another secure contract holder**

It is recognised that promoting transfers encourages contract holders' mobility, gives contract holders more choice about where they want to live and creates sustainability through best use of housing stock as well as assisting those contract holders who may be experiencing difficulty with affordability, due to the under occupation charge.

We will manage the process within the defined legislation. (Renting Homes Wales Act 2016, s114 and s118)

### **4.6 Name Changes**

A contract holder may want to put their contract in a new name even though they may be remaining as a contract holder of the property. This would mainly be due to a marriage, a divorce or for religious or family reasons.

We will check the details of the name change and will request to see and copy any formal documentation relating to the change of name such as:

- marriage certificate.
- divorce decree absolute.
- legal notification e.g., changes by deed poll.

A name change will be granted upon receipt of all the relevant information and documentation having been provided by the contract holder.

### **4.7 Adding a joint contract holder**

If an application to add a new joint contract holder is received, then we will ensure that the current contract holder and proposed contract holder are advised to seek independent advice about the implications of holding a joint contract.

We will ask for certain information to enable a decision to be made. We will manage the process within the defined legislation (Renting Homes Wales Act 2016, s49-51).

### **4.8 Withdrawal of a contract holder**

A joint contractor holder may request to withdraw from the contract. Usually this is because of the breakdown of a relationship, and it may be that the other joint contract holder has left the property. We will ensure that the joint contract holder is advised to take independent advice. If they still wish to proceed, we will manage the process within the defined legislation (Renting Homes Wales Act 2016, s111). It should be noted if a person withdraws from the contract the contract continues.

## **HOUSING & COMMUNITIES**

---

### **4.9 Ending a Contract upon death**

We recognise that this is a very difficult time for families of deceased sole contract holders and aim to deal with them in a sympathetic and understanding manner.

We will liaise with the family or the solicitor dealing with the estate if the family request that course of action. If necessary, we will ask for a copy of the death certificate to verify the death.

We will also request that the property is cleared of furniture, rubbish and personal possessions, offering appropriate advice should the family experience difficulties with the clearance.

All keys and access fobs for the property must be handed into any council office when the contract is terminated. In some circumstances arrangements may be made to collect the keys directly from the family.

If there are any rent arrears outstanding or any other charges and recharges to be recovered, we will seek to recoup this through the estate.

### **4.10 Contract holders and temporary absence**

We recognise that there will be times when a Contract Holder will be absent from the property on a temporary basis for a number of reasons, which may include hospital admission, respite care or short-term prison. In these circumstances we will work with the Contract Holder and relevant organisations such as Probation and Social Services to ensure appropriate advice is provided to limit any financial impact/hardship on all parties. In certain circumstances it may be required to ascertain if the absence may be long term or permanent.

### **4.11 Lodgers and subletting**

We recognise that contract holders may wish to share their home with another person, especially with affordability and under occupation charges. Secure contract holders have a right to take in lodgers provided they do not overcrowd the home. They do however need to request and receive written permission from us to sublet part of their home.

We will not unreasonably withhold permission. Taking lodgers and subletting may impact on a Contract Holder's benefits and we will advise of this possibility and that the Contract Holder should seek appropriate advice from Housing Benefits, CAB etc.

It is important that we are notified of any lodger or anyone who sub-lets part of the home.

# HOUSING & COMMUNITIES

---

## 4.12 Decants

On occasion it may be necessary for a contract holder to vacate their home on a temporary or permanent basis. This may be due to either some major repair works being required at the property or some emergency situation arising. This process is known as decanting.

The type of repair and/or potential hazard will dictate the length of time that the contract holder needs to be housed elsewhere and this could range from days to, weeks or months.

Our aim is to minimise disruption and to return a contract holder to their home as soon as possible and to cause them the minimum inconvenience and cost.

## 5.0 Neighbourhood Management

The council recognises that we have an important role in the management of our neighbourhoods and not just contracts, even though that is our main purpose. The following section outlines some elements of the neighbourhood management to be undertaken.

### 5.1 Estate Walkabouts

In order to contribute to the wider neighbourhood management of estates we will conduct regular and programmed Estate Walkabouts involving local members and colleagues from other council departments [as appropriate]. We will record what we find and alert as appropriate other relevant services and departments. We will follow this up to ensure action is taken to keep our neighbourhoods an attractive place to live.

### 5.2 Management of Communal Areas

In order to comply with current fire safety regulations and also to keep the communal areas of our schemes whether it be sheltered or general needs, safe and free from hazards the council has adopted a sterile communal area approach to all internal communal areas. This means that all communal areas are not to be utilised for the storage of items which could pose a risk in the event of a fire – either due to combustibility or hindering egress in the event of an evacuation.

We recognise that some contract holders may want to enjoy the external communal areas and gardens so in some circumstances, following written consent from ourselves certain improvements maybe allowed such as installation of planters or hanging baskets as examples.

### 5.3 Open Spaces/Trees

## HOUSING & COMMUNITIES

---

The Housing Management Service will maintain communal areas and other open spaces, including boundary hedges and trees which is within the ownership of the service. This will be on a planned programme to ensure these areas are maintained to a high standard and enhance the environment on our estates.

We will also take into account any environmental impact and relevant legislation and/or wider council strategies when undertaking any maintenance.

<https://www.flintshire.gov.uk/en/PDFFiles/Countryside--Coast/Tree/Tree-Plan.pdf>

### **6.0 Customer Focus and Support**

We recognise the importance of understanding the diverse needs of our customers to ensure that we deliver customer focussed services shaped around the different needs of customer groups. We also understand the mutual benefit that can be realised if customers are able to sustain their contract successfully and in turn reduce costs to the council which are associated with failing contracts, high contract turnover and less stable communities.

#### **6.1 Tenant Sustainment**

We may support the sustainability of contracts by offering support to any contract holders who are experiencing difficulties with maintaining the obligations of their contracts due to either financial, medical and or other reasons.

We may do this by either direct involvement from the Tenant Sustainment Team who will support contract holders directly or by referrals to relevant specialist support services.

### **7.0 Equality and diversity**

We recognise that we operate in a community within which there is wide customer diversity, we aim to value that diversity and shape our services around the needs of our customers.

Through the management of our homes and estates we aim to treat all customers fairly, and with respect and professionalism regardless of their gender, race, age, disability, religion, sexual orientation and marital status. We will gather information on the diverse needs of our customers to ensure our services meet their needs and are consequently more efficient.

To enable all residents to have clear information and equal access to our available properties, we will publish clear information in a range of appropriate languages and formats and through a range of media on request. Feedback is also accepted



## HOUSING & COMMUNITIES

---

through a variety of different routes to reflect individual contract holder's preferences or needs.

### **8.0 Performance Management**

We will monitor customer satisfaction within our contract management services and the results will subsequently feed into our monitoring and review processes. We will establish a series of monthly and annual key performance indicators for our contract management services and report progress against these at monthly managers meetings. We will also make these available to contract holders through our various methods of communication and involvement.

We will monitor the cost of our contract management services and compare these through formal and informal benchmarking methods.

### **9.0 Policy review**

This policy will be reviewed in line with the councils Policy Review Framework. The policy will be reviewed every 3 years. In line with the councils continuous improvement strategy the policy review will incorporate an assessment of key internal and external influencers to ensure the policy reflects best practice together with all legal and statutory requirements.

### **10.0 Responsibility**

The Service Manager for Housing and Communities has overall responsibility for the successful delivery of the policy. The Housing Manager will ensure that all staff within the Neighbourhood and Customer services team are fully trained on their operational responsibilities in respect of contract management.

A full set of operational procedures will be available to support the delivery of this policy and these will be version controlled and easily available to staff for reference.

Mae'r dudalen hon yn wag yn bwrpasol



# **Anti-Social Behaviour Policy 2023**

## 1. MANAGEMENT INFORMATION

Date policy approved by Cabinet / Scrutiny	
Replacing / Updating	ASB Policy 2011
Next Review Date	April 2026
Drafted By:	Dawn Kent
Responsible Senior Officer	Vicky Clark
Circulation list	Available on Flintshire County Council website

## **1. Introduction**

- 1.1 Purpose of the Document
- 1.2 Definition of Anti-Social Behaviour
- 1.3 General Policy Statement on Anti-Social Behaviour
- 1.4 Strategic and Legislative Context
- 1.5 Preventing Anti-Social Behaviour and Nuisance

## **2. Tenant and Landlord Responsibilities**

- 2.1 Tenant Responsibilities
  - 2.1.1 Tenancy Agreement
  - 2.1.2 Tenancy Types
- 2.2 Landlord Responsibilities
  - 2.2.1 Approach to Dealing with Anti-Social Behaviour
  - 2.2.2 Working with Perpetrators
  - 2.2.3 Supporting Staff
  - 2.2.4 Confidentiality and Sharing Information

## **3. Tackling Anti-Social Behaviour**

- 3.1 Reporting Anti-Social Behaviour
- 3.2 Dealing with Anti-Social Behaviour
- 3.3 Remedies to Tackle Anti-Social Behaviour
- 3.4 Hate Incidents, Harassment and Discrimination
- 3.5 Illegal Drugs
- 3.6 Assault, Violence & Threatening Behaviour
- 3.7 Neighbour & Noise Nuisance

## **4. Victim Centred Approach**

- 4.1 Supporting Victims of Anti-Social Behaviour
- 4.2 Supporting Witnesses of Anti-Social Behaviour

## **5. Measuring Our Success**

- 5.1 Performance Management
- 5.2 Equality and Diversity
- 5.3 Complaints
- 5.4 Data Protection
- 5.5 Policy Review

## 1. Introduction

### 1.1 Purpose of the Document [Renting Homes Wales update]

Previously Section 218A of Housing Act 1996 required social landlords to publish a statement of policy in relation to anti-social behaviour (ASB) and procedures for dealing with any occurrences of anti-social behaviour, with the implementation of Renting Homes Wales [2016] this section is no longer relevant within Wales however it is felt to be good practice to have such a Policy in place.

This document is designed to give a clear statement of the approach of Flintshire County Council (the Council) as a landlord to tackle anti-social behaviour within the remit of the Housing Management Team and to provide guidance as to what constitutes prohibited Conduct [ASB], as defined under Renting Homes Wales [2016].

The Council will take a victim centered approach, taking action quickly, decisively and using a harm/risk-based approach. Dealing with all matters professionally and sensitively placing a strong emphasis on early intervention and positive communication. As a landlord we may work with other agencies, such as the police to take any appropriate action.

### 1.2 Definition of Anti-Social Behaviour

Chapters 7, Section 55 of the renting Homes Wales [2016] covers Anti-social Behaviour and other prohibited conduct and states clearly outlines what is prohibited conduct, this covered in more detail later on in this Policy Document.

*Additionally, Section 2 of the Anti-Social Behaviour, Crime and Policing Act 2014 defines anti-social behaviour as:*

- (a) Conduct that has caused, or is likely to cause, harassment, alarm or distress to any person,*
- (b) Conduct capable of causing nuisance or annoyance to a person in relation to that person's occupation of residential premises, or*
- (c) Conduct capable of causing housing-related nuisance or annoyance to any person.*

For the purposes of ASB cases reviews (the community trigger) ASB is defined as behaviour causing harassment, alarm or distress to members or any member of the public.

Anti-Social Behaviour can include the following examples:

- Drug related offences

- Violence or threats of violence and actual assault
- Intimidation and harassment
- Aggressive and threatening language and behaviour
- Hate crime or behaviour
- Noise and other neighbour nuisance
- Local environmental quality issues such as fly-tipping, vandalism and graffiti
- Illegal or immoral use of residential premises.

The Council recognises that the term Anti-social Behaviour can and does mean different things to different people, and what might appear to be acceptable behaviour for one resident, may not be acceptable to another. It should also be recognized that such behaviour may happen over a sustained and/or long period of time, making life very difficult for residents, or there might be one very serious incident of Anti-social Behavior which requires immediate intervention.

Not every complaint received will constitute anti-social behaviour and where this is the case no further action will be taken but appropriate advice and guidance will be given to the person reporting. This can be subject to review if there is a change or escalation in the circumstances.

Our approach focuses on tackling Anti-social Behaviour that either affects or is carried out by people living within our properties and our neighbourhoods. This includes Contract Holders and complainants, their family members (including children) or friends, owner-occupiers, lodgers or private Contract holders.

The intentions of the person/s carrying out the behavior will also be taken into account, as well as any disability and/or support needs they may have. It is important to state that Anti-social behaviour will not be tolerated.

Anti-Social Behaviour is not:

- Children playing in the street or local parks.
- Young people gathering socially.
- Being unable to park outside your home.
- One off parties/Celebrations
- DIY works at reasonable hours etc.

### **1.3 General Policy Statement on Anti-Social Behaviour**

Anti-social behaviour is unacceptable in our neighbourhoods, and we will:

- Not tolerate anti-social behaviour by or against our Contract holders and their families.

- Provide guidance to our Contract holders around and how to report any anti-social behaviour.
- To provide a strong victim focused approach.
- Treat reports all anti-social behaviour seriously.
- Carry out a careful and thorough investigation.
- Provide realistic expectations.
- Support perpetrators, as appropriate, to change their behaviour.
- Take appropriate relevant action at the right time.
- Work closely with other agencies and professionals where necessary.

#### **1.4 Strategic and Legislative Context**

This document is designed to meet our statutory obligations that impact on the way we deal with cases of Anti-social Behaviour and our duties as a Housing Management Team Our Policy Objectives are:

- To work with North Wales Police and other relevant agencies in sharing information to ensure most appropriate action is taken against a perpetrator.
- To work in partnership with other Registered Social Landlords and Private Landlords/tenants to resolve any issues of anti-social behaviour in our communities.
- To adopt a multi-agency approach to resolve anti-social behaviour on our estates and take a lead role in coordinating this approach.
- To ensure good working relationships with those service areas and agencies facilitating support.

#### **1.5 Preventing Anti-Social Behaviour**

We will work with other agencies in relation to diversionary measures as well as stopping anti-social behaviour, criminal and/or nuisance behaviour and preventing reoccurrence.

We will, in some cases, consider mediation, acceptable behaviour contracts, restorative justice and the use of other non-legal measures in the first instance where appropriate.

In certain cases of anti-social behaviour, for example, serious or cases which are not able to be resolved with early intervention consideration will be given to legal remedies as deemed appropriate.

## **2. Contract Holder and Landlord Responsibilities**

### **2.1 Contract Holder Responsibilities**

The Council's Contract Holders are subject to the terms of the Occupation Contract, which sets out the behaviour expected of them, and anyone else living at or visiting the property.



All tenants are provided with an Occupation Contract at the outset of their Occupational Contract and the clauses relating to anti-social behaviour are explained to them.

## **2.2 Occupational Contract**

The Council has two Occupation Contracts currently being issued:

- New Secure Occupation Contract, which is issued to all new Contract Holders taking up occupation since 1st December 2022, when the Renting Homes Wales [2016] commenced
- Converted Secure Occupation Contract, which all existed Tenants who held a tenancy with the Council at the time Renting Homes Wales commenced.

Anti-social Behaviour is covered by a fundamental term which deals with what is known as Prohibited Conduct. It is a fundamental term of the Occupation Contract, which cannot be modified therefore the council cannot include additional terms within the Occupation Contract which relate to Anti-social Behaviour, however it can [and does] provide more detailed explanation for the Contract Holder.

It should be noted that any behaviour of the Contract Holder themselves is covered under Renting Homes Wales [2016] so any action can be taken directly against the Contract Holder by way of breach. If there are Joint Contract Holders then there is provision for action to be taken against either or both.

If the complaints of Anti-social Behaviour relate to the actions of someone who is not a Contract Holder, then the Contract Holder is deemed to be liable for their behaviour only if it can be proven that they [Contract Holder] allowed, incited or encouraged the behaviour – this is a fundamental change compared to the previous Housing Act, therefore a more robust approach will be taken when investigating complaints of Anti-social Behaviour concerning family, friends and visitors of Contract Holders.

## **2.4 Landlord Responsibilities**

### Approach to Dealing with Anti-Social Behaviour

We are committed to taking a victim centred approach in tackling anti-social behaviour, with an emphasis on risk assessment, early intervention and regular contact/support with victims and witnesses.

Our approach will be proportionate and fair, depending on the facts of each case. For example, in appropriate cases we will consider early intervention methods such as mediation and acceptable behaviour contracts, to provide opportunities for unacceptable behaviour to be rectified.

We will work closely with North Wales Police to deal with serious cases of Anti-social Behaviour. We share relevant information and based on evidence gathered, and in conjunction with our legal team and relevant legislation and will decide in all cases upon the most appropriate action based on evidence.

#### Working with Perpetrators

When dealing with perpetrators our response will depend on the nature of the offending behaviour. In many cases of there may be underlying causes such as:

- Drug addiction
- Alcohol addiction
- Mental health issues
- Learning difficulties
- Family or relationship breakdown
- Adverse Childhood Experiences [ACE's]

Individuals whose Anti-social Behaviour is a consequence of one or more of the issues listed above may sometimes require additional support in maintaining their Occupation Contracts and addressing their behaviour. When dealing with vulnerable individuals we will consider the factors which may be contributing to neighbour nuisance before deciding on an appropriate course of action.

We may refer perpetrators for support, however we may take enforcement action, including possession actions where this is proportionate and reasonable.

#### Supporting Staff

We will provide effective and regular training and support to ensure staff are competent and confident to tackle Anti-Social behaviour, to include any changes to current legislation.

We will ensure relevant training and systems are in place to maintain the safety and wellbeing of staff and will not tolerate threats or violence against council employees or their agents. Where such behaviour can be proved to the satisfaction of the County Court an injunction may be obtained, consideration will also be given to alternatives such as a claim for possession in the most serious or persistent cases.

Our Policy objectives and standards around supporting staff which will ensure:

- That perpetrators of verbal threats, intimidation or violence against staff may face appropriate legal action

- That staff are trained to ensure compliance with legislation and policies including health and safety and the lone working policy.
- Staff are required to report all incidents of verbal abuse, threats and assaults to the appropriate manager.
- Preventative and protective action will be taken depending on risk assessment of task or where perpetrator is known or perceived to be a risk. Risk assessments are to be maintained and updated regularly.

#### Partnership working

Sharing information is an integral part of dealing with anti-social behaviour.

We will share information with other organisations as part of a strategy to reduce crime and disorder. We will do this in compliance with the law and with any protocols or agreements in place.

### **3. Tackling Anti-Social Behaviour**

#### **3.1 Reporting Anti-Social Behaviour**

We will assist in taking action against Contract Holders who are behaving or are affected by Anti-social Behaviour which can reported to us by contacting the Housing Management Team or by contacting a Local Connects Office which are located in Mold, Buckley, Flint, Holywell or Connahs Quay this will then be directed to the relevant Neighbourhood/Tenancy Enforcement Officer.

**If the anti-social behaviour also constitutes as a crime it should be reported to the police by phoning 101, or in an emergency, by phoning 999.**

#### **3.2 Dealing with Anti-Social Behaviour**

When a report of Anti-social Behaviour is received, if it requires an urgent response, for example, incidents of Hate Crime, harassment, violence or criminal behaviour, the Council will aim to contact the complainant within one working day. Complainants should also be encouraged to report such incidents to North Wales Police

In less serious such as noise from visitors, animal nuisance, neighbour disputes etc then the Council will aim to contact the complainant within three working days.

It should be noted that in cases relating to noise, the complainant should also be encouraged to report the issue to Noise Pollution, Environmental Health as they have statutory powers to deal with Noise related cases. It should be noted that Environmental Health will not take third party referrals from the Enforcement Team.

Having the Enforcement Team deal with all complaints of Anti-social Behaviour allows for a consistent approach to investigation, evidence gathering and advice/support to complainants.

The Council will also:

- Treat the information you provide to us as confidential under the GDPR guidelines.
- Take all complaints seriously and investigate them thoroughly.
- Making the safety of complainant a primary focus.
- Consider how best to support complainants
- Provide complainants with regular updates.
- Work as part of a multi-agency partnership e.g. with Police and other relevant agencies.
- Use informal and also legal remedies to solve the problem.

### **3.3 Remedies to Tackle Anti-Social Behaviour**

We may decide to use a variety of early, informal remedies and legal remedies to resolve Anti-social Behaviour which can include the following listed below, (please note this is not an exhaustive list of the options available).

#### Mediation

Where the Anti-social Behaviour is low-level and there are no threats of violence, Mediation may be used to quickly resolve any issues before any escalation.

#### Meetings

Relevant Officers may meet with alleged perpetrators to discuss their behaviour and any other concerns this will include any actions that can be taken by the alleged perpetrator and the Officers to resolve the complaint. The Officers will gather relevant evidence and this can be helpful in resolving issues at an early stage.

#### Verbal Warning

A warning advises a person what behaviour is causing the issue, what effect this is having on the victim or the wider community, and the consequences of non-compliance or non-engagement.

#### Acceptable Behaviour Contracts

ABCs are an informal, voluntary agreement between an individual who has committed anti-social behaviour, and a local agency whose role includes protecting victims and communities from such behaviour. Such contracts can be put in place if both parties agree and can stop further escalation of anti-social behaviour.

### Partnership Visits with Other Relevant Agencies

Relevant Officers may carry out visits with partners within the Council or with outside agencies, such as Housing Officers and the police. These visits can stress how serious the matter is, the effect their behaviour is having on the complainant or community, and the consequences if they continue to behave in an anti-social way.

### Restorative Approach

Restorative Approach focuses on resolving conflicts and supporting people to take responsibility to solve them. It encourages effective communication and working towards positive outcomes.

A Restorative Conference brings all parties of a conflict together including family and friends to talk openly about how they have been affected and what needs to happen to make things better.

### CCTV for Target Hardening

Installing CCTV can be a useful tool in some cases. It can collect evidence of the anti-social behaviour, reassure the victim and can act as a preventative measure towards any further anti-social behaviour.

### Community Protection Notices

Community Protection Notices will be sought – in partnership with other agencies, such as North Wales Police.

### Formal Warning

A formal warning would clearly state which tenancy conditions have been breached, details of the breach and explain the consequences of any further breaches.

### Final Warning

If the anti-social behaviour persists after a formal warning has been issued or if the situation escalates further, then a final warning may be issued, this is often the final stage before starting possession proceedings. A final warning may be issued before any other interventions due to the severity of the anti-social behaviour.

### Injunction

In certain cases and following appropriate legal advice being obtained it may be appropriate for the Council to seek an injunction to assist with resolving the issues of ASB either against the tenant or anyone else living in the area to stop them behaving in a way which causes nuisance or annoyance to other people living in or visiting the rented property or the area itself.

### Possession

Possession action maybe sought against the Contract Holder or Holders on the basis of a breach of Occupation Contract

Seek a Court Order imposing a Standard Contract on the basis of the conduct [a prohibited Conduct Standard Contract].

It should be noted that in the circumstances of a Joint Occupation Contract, the Council may decide to seek an order to end the Occupation Contract for the Contract Holder who is causing the breach of Occupation Contract.

If the Council is seeking to end the Occupation Contract, Renting Homes Wales [2016] then it must follow the relevant guidance within the Act and serve upon the Contract Holder the relevant prescribed form [RHW23] and may commence proceedings immediately the RHW23 has been served.

### **3.4 Hate Incidents, Harassment and Discrimination**

We will not tolerate any form of hate incident. A hate incident may or may not constitute a criminal offence. A hate incident is one perceived by the victim or any other person as being motivated by prejudice or hate. The prejudice may be about the victim's disability, race or ethnicity, religion or belief, age, sexual identity or transgender identity.

Incidents are not only limited to physical attacks on persons and/or damage property but also includes verbal abuse and graffiti or any other behaviour that causes distress or harm to the victim.

Where appropriate we will use legal remedies against anybody found perpetrating this type of behaviour.

### **3.5 Illegal Drugs**

We will not tolerate any form of illegal drug activity by our Contract Holders, anyone living with them or visiting them and will work with North Wales Police and other agencies.

Where it is deemed appropriate the Council will use relevant legal remedies against anybody found perpetrating these types of crime. Examples of this including growing cannabis, dealing drugs etc.

### **3.6 Violence, Assaults or Threatening Behaviour**

We will not tolerate the use of threatening, abusive or violent behaviour by Contract Holders and/or anyone living with them, visiting them towards their neighbours, Council

staff, subcontractors, agents or the wider community. The Council will work closely with the North Wales Police and other agencies and take appropriate action.

### **3.7 Neighbour Nuisance or Disputes**

The Council recognises that people are different and are in some cases are likely to have different lifestyles, working pattern, beliefs and that living close to others will sometimes result in noise or activity that a person may find to be annoying.

Incidents – such as normal everyday noise, cooking smells as examples are not Anti-social Behaviour and in such incidents, it may be decided that no further action will be taken. However, we will not tolerate behaviour which does constitutes Anti-social Behaviour and will take appropriate action.

## **4. Victim Centred Approach**

### **4.1 Supporting Victims of Anti-Social Behaviour**

We will ensure that it is easy to report Anti-social Behaviour and will provide support, where appropriate, to complainants, victims or witnesses. The Council will work with other agencies and professionals that may be able to help when dealing with any problems and if considered necessary offer any appropriate support.

All reports will be dealt with sensitively, if required, in confidence.

We aim to do this by supporting victims of Anti-social Behaviour to:

- To make is easy and accessible for victims to report any Anti-social Behaviour to ensure that staff keep complainants, witnesses and victims informed.
- To have a sensitive and proactive approach working with other agencies where appropriate to offer support and assistance.
- Ensure that there are discussions and an action plan developed with the person reporting anti-social behaviour.
- To protect the confidentiality of people reporting issues, where possible.
- Maintain regular contact with complainants, victims and witnesses.
- Provide protection measures such as target hardening working alongside The Community Safety Team.

### **4.2 Supporting Witnesses of Anti-Social Behaviour**

We will support witnesses of Anti-social Behaviour and work with them to secure a successful outcome where anti-social behaviour occurs. We will aim to protect witnesses and work in partnership with North Wales Police and other agencies as appropriate to ensure that witnesses feel secure and are supported throughout the process. The aim is

to alleviate any fears of intimidation, will include any referrals to victim support, keeping witnessing informed at all stages, target hardening measures as well as CCTV installation should this be deemed an appropriate measure of support.

## **5. Measuring Our Success**

### **5.1 Performance Management**

We will monitor tenant satisfaction with our tenancy management services, the results will subsequently feed into our monitoring and review processes.

We will establish a series of monthly and annual key performance indicators for our tenancy management services and report progress against these at monthly managers meetings. We will also make these available to tenants through our various methods of communication and involvement.

We will monitor the cost of our tenancy management services and compare these through formal and informal benchmarking methods.

### **5.2 Equality and Diversity**

We recognise that we operate in a community and neighbourhoods within which there is wide diversity, we aim to value that diversity and aim to shape our services around the needs of our tenants.

Through the management of our homes and estates we aim to treat all Contract Holders fairly, and with respect and professionalism regardless of their gender, race, age, disability, religion, sexual orientation and marital status. We will gather information on the diverse needs of our tenants to ensure our services meet their needs and are consequently more victim/customer focussed.

### **5.3 Complaints**

Any complaints about how a case of Anti-social Behaviour has been handled are to be dealt with through the Council's Corporate Complaints procedure or through the community trigger. This information is available to anyone via accessing the Council's website or via a visit a Connects Offices for further guidance on how to make a complaint.

### **5.4 Policy Review**

This policy will be reviewed every three years, or where there has been significant changes to regulation or legislation to warrant a further policy review. The policy may also be reviewed sooner where there is a need to address operational issues or where best practice has evolved and there is a need to incorporate this.



# Eitem ar gyfer y Rhaglen 14



## CABINET

<b>Date of Meeting</b>	Tuesday, 16 <sup>th</sup> January 2024
<b>Report Subject</b>	Bailey Hill, Mold
<b>Cabinet Member</b>	Cabinet Member for Climate Change and Economy
<b>Report Author</b>	Chief Officer (Planning, Environment and Economy)
<b>Type of Report</b>	Operational

## EXECUTIVE SUMMARY

Bailey Hill in Mold is a Council-owned green space in the heart of Mold incorporated the remains of Mold Castle. Previously overgrown and under-used, the site has been restored to be a valuable community resource through a tripartite partnership between the Council, Mold Town Council, and the Friends of Bailey Hill. This report provides a summary of the project that has been undertaken.

## RECOMMENDATIONS

1	That Cabinet note the successful completion of development at Bailey Hill in Mold.
---	--

## REPORT DETAILS

<b>1.00</b>	<b>EXPLAINING THE PROJECT AT BAILEY HILL, MOLD</b>
	<u>Background</u>
1.01	The Bailey Hill in Mold incorporates the remains of a Norman motte and bailey castle, a public park, a custodian's cottage, and a former bowling green and playing area. The Council owns the site. The site had become very overgrown and unwelcoming, little-used by Mold residents and subject to anti-social behaviour. Most of the site is a Scheduled Ancient Monument.
1.02	Stakeholders in Mold had been championing Bailey Hill for some time as an underutilised asset in the town capable of playing a more positive role in the town centre as a recreation and cultural asset for local people.
1.03	As part of the Council's transformation programme, the concept of a tripartite partnership arrangement for Bailey Hill was agreed; bringing together the Town Council, County Council and Friends group to develop the site and better manage it. This partnership is embodied in a written but non-binding agreement between the parties.
	<u>The development of Bailey Hill</u>
1.04	The partnership agreed a major redevelopment proposal for the site which would restore its physical appearance, improve facilities for users and enable the site to better host events and activities. To deliver these aspirations, the partnership developed a series of funding bids which resulted in over £1.7m of funding being secured for the site. The funding included: Heritage Lottery Fund £1,138,688 Welsh Government £123,740 Landfill Tax £49,600 Cadwyn Clwyd £157,575 Mold Town Council £15,080 Mold Mayoral Charity £9,000 Friend of Bailey Hill £2,809 Flintshire County Council £225,000
1.05	The development work on Bailey Hill included: <ol style="list-style-type: none"> <li>1. The redevelopment of the Custodian's Cottage – retaining residential use upstairs and creating lettable community and interpretation space downstairs together with kitchen, tool store, accessible toilet, and office space.</li> <li>2. Improving the entrance to Bailey Hill to create accessible routes, enable limited vehicle movements for events and improve the setting of the war memorial.</li> <li>3. Improving the walking routes to the two main open spaces on the site.</li> <li>4. Installing an electricity supply into the site to support events.</li> <li>5. Replacing the play area.</li> </ol>

	<p>6. Repairing the boundary wall.</p> <p>In addition, a programme of community engagement activities and events was supported to re-engage the people of Mold, especially schools, in their site.</p>
1.06	<p>The headline breakdown of costs for the project, as of the time of writing, include:</p> <p>Capital works £949,932  Fees £189,654  Staff £137,000  Activity costs £186,406  Play area £138,300 (due on site imminently)  Boundary wall £100,000</p>
1.07	<p>The works on site were competitively procured with TG Williams appointed to undertake the works with Harrison Design Development from Mold appointed to manage the construction project. The Museums Officer from Aura managed the overall project including the complex funding package as well as providing expert advice on the sensitive archaeology of the site and liaising with CADW throughout delivery. Mold Town Council employed the project officer for Bailey Hill who co-ordinated the work of the different partners, recruited and supported volunteers, promoted the site and the activities, and developed an imaginative events programme and school engagement. The improvements to the boundary wall were delivered by the County Council Streetscene team. The replacement of the play area is currently being managed by Aura.</p>
1.08	<p>Work started on site in 2019 and was significantly delayed due to the Covid pandemic. The contractor TG Williams provided a high level of flexibility and responsiveness through the constraints that the pandemic brought. In addition, a number of important archaeological finds on the site, outlined below, also created significant delays and design changes. Except for the play area, all other construction works on site are complete.</p> 



1.09



All works on the site have been subject to consent from CADW and have been closely monitored by archaeologists from the Clwyd Powys Archaeological Trust. This resulted in a number of very interesting and unexpected discoveries:

1. Possible defensive wall and floor levels of a building were found at the base of the motte. This was dated by associated Twelfth / Thirteenth century pottery sherds. We hope to get funding for radiocarbon dating the charcoal content of the mortar. Large ash deposits indicate the building was likely to have been a kitchen range.
2. Elsewhere on site, a large defensive three-metre-thick wall was found, again probably Norman. Due to its size and thickness this is likely to be the outer defensive wall of the castle. Historically it was believed that a stone structure had been erected on the top of the motte but the rest of the site would have had wooden palisade defences and buildings. The large number of stone structures indicate that the Bailey Hill site played a far greater role in the history of the area than previously thought. Considerable time, effort and money had been spent to fortify the site.
3. Seven historic skeletons were found lying east-west (so possibly Christian) in the area developed for the outdoor stage. The skeletons are from both men and women and include a child. All remains have now been removed from site. Historical records mention skeletons being found in the past, but it was always believed that these were disarticulated and in a ditch or pit, having been dumped post battle. The skeletons have been sent to Durham University for analysis to identify their sex, height, health, and age at death. We are unsure of their historical date as there were no associated archaeological features / finds. Radiocarbon dating will hopefully tell us when they lived and further analysis may tell us their origin.



4. Other important finds include early Medieval arrowheads.



	 <p>4. Other important finds include early Medieval arrowheads.</p> 
1.10	The interpretation for the site has been delayed to reflect the exciting archaeological finds and what they may mean in terms of our understanding of the history of Bailey Hill.
1.11	The Centre is open to the public on Thursday each week and is used, on a prebooked basis, by a variety of local community groups. It is also available as a base for the Friends group to use when they undertake their volunteer days.
1.12	The Friends of Bailey Hill (Ffrindiau Bryn y Beili) have played a significant role in improving the appearance of the site. They have undertaken a major planting programme throughout the park, in close liaison with the Council Streetscene team, have erected bird boxes and planters and undertaken general site improvement works above those that the Council

has been able to manage. The group has also been an invaluable set of ears and eyes on the ground and undertake much of the day-to-day liaison with the public. The volunteers from the group have attended the site most weeks with over 150 practical sessions now completed.



1.13 In addition, Mold Town Council recruited a pool of volunteers who have done vital work in researching the history of Bailey Hill. Other volunteers have also helped to keep the Centre open, support events and deliver guided walks.

Future arrangements

1.14 The tripartite arrangement remains in place and is now responsible for the ongoing management of the site. Flintshire County Council remains the landowner and is responsible for the day-to-day maintenance of the site as a whole. Mold Town Council operate the Centre on site and support volunteers and events on the site. The Friends of Bailey Hill are providing additional services to further enhance the appearance of the site, improve biodiversity and liaise with local people. A detailed management and maintenance plan is in place to define the roles of the three partners which is currently being refreshed.

1.15 The site has now been awarded the annual Green Flag award three times by the awarding body. It is a condition of the Lottery funding that this status is retained for seven consecutive years.

1.16	The site is now host to a weekly Men's Sheds project which supports men who might otherwise face isolation and loneliness. A number of youth organisations are also keen to use the site on a regular basis as an accessible and safe "wild" green space.
1.17	No further major projects are planned for Bailey Hill once the play area investment has been completed. The Friends will continue to improve the quality of the garden environment and biodiversity on site and the site will be marketed by the Town and County Councils as a resource for local people and visitors.

<b>2.00</b>	<b>RESOURCE IMPLICATIONS</b>
2.01	The Centre, even once the income from residential and community lettings has been considered, runs at a deficit each year and will always do so. At present, Mold Town Council have been bearing this cost. The tripartite partnership will need to review the operation of the Centre and more fairly distribute the operation and costs of the Centre between them in line with the original concept for the site.
2.02	The costs arising from the arrangement cannot be quantified at this stage but are likely to be sufficiently small as to be able to be absorbed within the Enterprise and Regeneration service budget.

<b>3.00</b>	<b>IMPACT ASSESSMENT AND RISK MANAGEMENT</b>														
3.01	<p><b>Ways of Working (Sustainable Development) Principles Impact</b></p> <table border="1"> <tr> <td>Long-term</td> <td rowspan="5">This project was conceived in line with these principles. It has been a community-led project with close involvement from local stakeholders throughout. The project has been working towards long terms solutions to improving a problematic and underused urban site and creating a valued community resource.</td> </tr> <tr> <td>Prevention</td> </tr> <tr> <td>Integration</td> </tr> <tr> <td>Collaboration</td> </tr> <tr> <td>Involvement</td> </tr> </table> <p><b>Well-being Goals Impact</b></p> <table border="1"> <tr> <td>Prosperous Wales</td> <td rowspan="7">The site has the potential to play a role in supporting footfall in the town centre. It is a valuable resource for informal recreation in the town and now is well-used by local people. It is also a valuable education and cultural resource with most local schools having used it at least once. A number of groups use the site for well-being activities. The site is also being improved as a biodiversity resource in an urban area.</td> </tr> <tr> <td>Resilient Wales</td> </tr> <tr> <td>Healthier Wales</td> </tr> <tr> <td>More equal Wales</td> </tr> <tr> <td>Cohesive Wales</td> </tr> <tr> <td>Vibrant Wales</td> </tr> <tr> <td>Globally responsible Wales</td> </tr> </table>	Long-term	This project was conceived in line with these principles. It has been a community-led project with close involvement from local stakeholders throughout. The project has been working towards long terms solutions to improving a problematic and underused urban site and creating a valued community resource.	Prevention	Integration	Collaboration	Involvement	Prosperous Wales	The site has the potential to play a role in supporting footfall in the town centre. It is a valuable resource for informal recreation in the town and now is well-used by local people. It is also a valuable education and cultural resource with most local schools having used it at least once. A number of groups use the site for well-being activities. The site is also being improved as a biodiversity resource in an urban area.	Resilient Wales	Healthier Wales	More equal Wales	Cohesive Wales	Vibrant Wales	Globally responsible Wales
Long-term	This project was conceived in line with these principles. It has been a community-led project with close involvement from local stakeholders throughout. The project has been working towards long terms solutions to improving a problematic and underused urban site and creating a valued community resource.														
Prevention															
Integration															
Collaboration															
Involvement															
Prosperous Wales	The site has the potential to play a role in supporting footfall in the town centre. It is a valuable resource for informal recreation in the town and now is well-used by local people. It is also a valuable education and cultural resource with most local schools having used it at least once. A number of groups use the site for well-being activities. The site is also being improved as a biodiversity resource in an urban area.														
Resilient Wales															
Healthier Wales															
More equal Wales															
Cohesive Wales															
Vibrant Wales															
Globally responsible Wales															

Risk management	
Risk	Mitigation
Costs of operating the Centre	The tripartite relationship will look to minimise and fairly apportion costs between the partners.

<b>4.00</b>	<b>CONSULTATIONS REQUIRED/CARRIED OUT</b>
4.01	The Bailey Hill project was extensively consulted upon with local stakeholders including the schools in Mold.

<b>5.00</b>	<b>APPENDICES</b>
5.01	None.

<b>6.00</b>	<b>LIST OF ACCESSIBLE BACKGROUND DOCUMENTS</b>
6.01	None.

<b>7.00</b>	<b>CONTACT OFFICER DETAILS</b>
7.01	<b>Contact Officer:</b> Niall Waller Enterprise and Regeneration Manager <b>Telephone:</b> 01352 702137 <b>E-mail:</b> <a href="mailto:niall.waller@flintshire.gov.uk">niall.waller@flintshire.gov.uk</a>

<b>8.00</b>	<b>GLOSSARY OF TERMS</b>
	<p><b>Bailey</b> – an enclosed space within a castle</p> <p><b>CADW</b> – The Welsh Government department charged with protecting and celebrating the Welsh built environment.</p> <p><b>Motte</b> – an artificial mound forming part of the defences of a castle.</p> <p><b>Scheduled Ancient Monument</b> – a designated site of national importance protected from unauthorised change.</p>



# Eitem ar gyfer y Rhaglen 15



## CABINET

<b>Date of Meeting</b>	Tuesday, 19 <sup>th</sup> January 2023
<b>Report Subject</b>	Wales Coast Path Access Barrier Review Update
<b>Cabinet Member</b>	Cabinet Member for Climate Change and Economy
<b>Report Author</b>	Chief Officer (Planning, Environment and Economy)
<b>Type of Report</b>	Operational

### EXECUTIVE SUMMARY

Flintshire County Council appointed a consultant to undertake a review of the existing access control measures in place on a section of the Wales Coast Path (WCP) between Chester and Queensferry.

The recommendations from the consultant study were discussed at Flintshire Local Access Forum, Environment Overview & Scrutiny Committee and Cabinet in July 2023. The resolution at Cabinet was to gain further feedback from users and stakeholders when implementation designs were established.

A Plan and specification were drawn up for access points to the Wales Coast Path around the Saltney footbridge area and sent out for feedback during October. A summary of responses is detailed. Environment Overview & Scrutiny Committee considered the feedback 19<sup>th</sup> December.

The option presented highlights the opportunities and risks to the Authority.

### RECOMMENDATIONS

1.	That Cabinet note the feedback on the proposed access improvements and the potential risks to the Authority.
2.	That Cabinet agrees to the proposed improvements to the access points as detailed in the plan and specification.

## REPORT DETAILS

1.00	EXPLAINING THE ACCESS BARRIER REVIEW UPDATE
1.01	<p>Flintshire County Council appointed a consultant to undertake a review of the existing access control measures in place on a section of the Wales Coast Path (WCP) between Chester and Queensferry. The study reviewed the background context, legislations, barrier dimensions and user constraints in order to put forward recommendations for all 14 access points from Chester to Deeside.</p>
1.02	<p>The access control barriers are in place to protect users of the WCP against the risks posed by illegal vehicle access to the path, however, the existing barriers can cause access issues to users of some mobility scooters &amp; unconventional cycles. Recommendations to improve access are balanced against any impact of such amendments on illegal vehicle accessibility.</p>
1.03	<p>It is important to note that improving access for all legitimate users of the path will necessitate the widening of existing openings or removing the barriers altogether, which in turn reduces the effectiveness of the access control measure in preventing illegal access.</p> <p>As such, it will not be possible for access for all legitimate users to be improved entirely whilst still retaining the same level of access control to prevent use for vehicles such as cars &amp; motorcycles.</p>
1.04	<p>North Wales Police have highlighted significant concerns regarding the removal of the barriers however they understand the need for adjustments. Their concerns are for the safety of the public and to prevent the use of off-road motorbikes along the coastal path. They report seeing an increase in county lines (drug selling) along the coast path which they are working on methods to prevent. They also state the barriers are reducing/preventing any accidents by slowing pedal cycles/preventing motor bikes from accessing the area. Therefore, they are requesting that they are not removed and that they are adjusted to enable any disability groups access to the coastal path but also stopping any illegal bikes.</p>
1.05	<p>The Equality Act 2010 provides legal protection to people from discrimination based on a range of characteristics including disability, age, race, sexual orientation. The Act requires service providers to make reasonable adjustments for disabled persons so as they are not disadvantaged either directly or indirectly from using services and facilities when compared to those without disabilities.</p>
1.06	<p>In 2022 Flintshire Legal Team advised that each individual public path should be considered separately with regard to the necessity of installing a barrier in terms of its own community users and a balance sought between the requirement for barriers on a right of way (e.g. in terms</p>

	of public safety) whilst considering the needs of certain disability access within that community. The Council only has to do what is reasonable. The Local Authority is encouraged to consult with the local disabled people in the area to decide what reasonable adjustments may be needed in that particular area.
1.07	Following the recommendations of the consultant's study, a plan and specification was drawn up to improve accessibility in the Saltney footbridge area by amending the current access point to include a radar lockable gate, (Appendix 1). Feedback was invited on this scheme from the community, disabled users and stakeholders. (Appendix 2)
1.08	The scheme does allow for improved access for those with a Radar key who currently cannot access the A frame barriers and it retains control of illegal ingress of motorbikes. However, feedback indicates this option will still present access problems in terms of key operation and manoeuvrability. Other issues highlighted include the ease in which non-disabled people can obtain a radar key and if the gate was left open or the lock was vandalised.
1.09	The proposed scheme, once installed, will be reviewed after 6 months to understand its effectiveness for control of illegal access and problems encountered by legitimate users.
1.10	A draft Equalities Impact Assessment has been carried out on the proposed scheme. (Appendix 3)

<b>2.00</b>	<b>RESOURCE IMPLICATIONS</b>
2.01	The Review was funded by Natural Resources Wales WCP grant fund.
2.02	An application for funding from Natural Resources Wales WCP grant has been made to implement recommendations within this pilot area.

<b>3.00</b>	<b>CONSULTATIONS REQUIRED / CARRIED OUT</b>
3.01	North Wales Police and Natural Resources Wales (NRW) were consulted on the consultant's study and their views fed into the recommendations and are supportive of the approach. The study was also shared with individual members of the disability community who have expressed an interest or concern in accessing the WCP.
3.02	The Environment and Economy Overview and Scrutiny Committee and Flintshire Local Access Forum (LAF) discussed the report 11 <sup>th</sup> July 2023. The Committee and forum supported the recommendations in principle subject to further consultation with appropriate user groups.
3.03	Users and stakeholders were asked for feedback on the plan and specification for improvements at Saltney footbridge during October. Summary of responses included in Appendix 2.

3.04	<p>The Environment and Economy Overview and Scrutiny Committee considered the update report following the consultation of users and stakeholders on 19<sup>th</sup> December 2023.</p> <p>A wide range for comments were received from members of the committee and are summarised as follows:</p> <ul style="list-style-type: none"> <li>- Fundamentally disagree with the proposal, this is a retrograde step and barriers should be removed to allow access for all. Increased visitor numbers will reduce illegal access. We should be acting within the spirit of the legislation.</li> <li>- Path safety is paramount, this is a compromise which should be supported.</li> <li>- 6-month review period is too long and there needs to be further consideration to what the options will be after the review period</li> <li>- The proposals are worth trying. Need to look at other access points in the area.</li> <li>- Radar locks can be difficult to operate, the use of chicane barriers to slow speeds should be considered.</li> <li>- The proposal does not work, radar keys are widely available.</li> <li>- Are there lessons to be learnt from other Authorities in the same position.</li> </ul> <p>The committee voted 6 in favour, 3 against the proposals.</p>
------	---

<b>4.00</b>	<b>RISK MANAGEMENT</b>
4.01	There is a risk of a discrimination claim being made against Flintshire County Council under the provisions of the Equality Act (2010) as the proposed scheme still inhibits some disabled users.
4.02	Transport for Wales (who award Active Travel Transport Grant on the Welsh Government's behalf) have indicated that having barriers that do not conform to the Active Travel Act or the Equalities Act may be a risk to future funding, however it is interpreted that this relates to new schemes which form an application for funding and not existing provision.
4.03	If Flintshire County Council remove or widen the access to the path there may be an increase in illegal motorbike incursion, and it may lead to an increase in crime associated with County Lines and motorbikes present a public safety risk to all legitimate users of the path.

<b>5.00</b>	<b>APPENDICES</b>
5.01	Appendix 1 – Proposed plan and specification of access improvement at Saltney footbridge area.
5.02	Appendix 2 – Summary of feedback from users and stakeholders
5.03	Appendix 3 – Draft Equality Impact Assessment

<b>6.00</b>	<b>LIST OF ACCESSIBLE BACKGROUND DOCUMENTS</b>
6.01	<p><b>Contact Officer:</b> Tom Woodall, Access &amp; Natural Environment Manager  <b>Telephone:</b> 01352 703902  <b>E-mail:</b> <a href="mailto:tom.woodall@flintshire.gov.uk">tom.woodall@flintshire.gov.uk</a></p>

<b>7.00</b>	<b>GLOSSARY OF TERMS</b>
7.01	<p><b>Wales Coast Path</b> - National walking route covering 870miles of the Welsh Coast</p> <p><b>Natural Resources Wales</b> - Natural Resources Wales is the largest Welsh Government Sponsored Body, formed in April 2013, largely taking over the functions of the Countryside Council for Wales, Forestry Commission Wales and the Environment Agency in Wales</p> <p><b>Local Access Forum (LAF)</b> - The Local Access Forum is a statutory, independent advisory body of 12-20 volunteers, giving informed strategic advice to the Rights of Way and Countryside Service. The primary objective is to improve access and open air recreation to the countryside for everyone.</p>

Mae'r dudalen hon yn wag yn bwrpasol

Tudalen 399

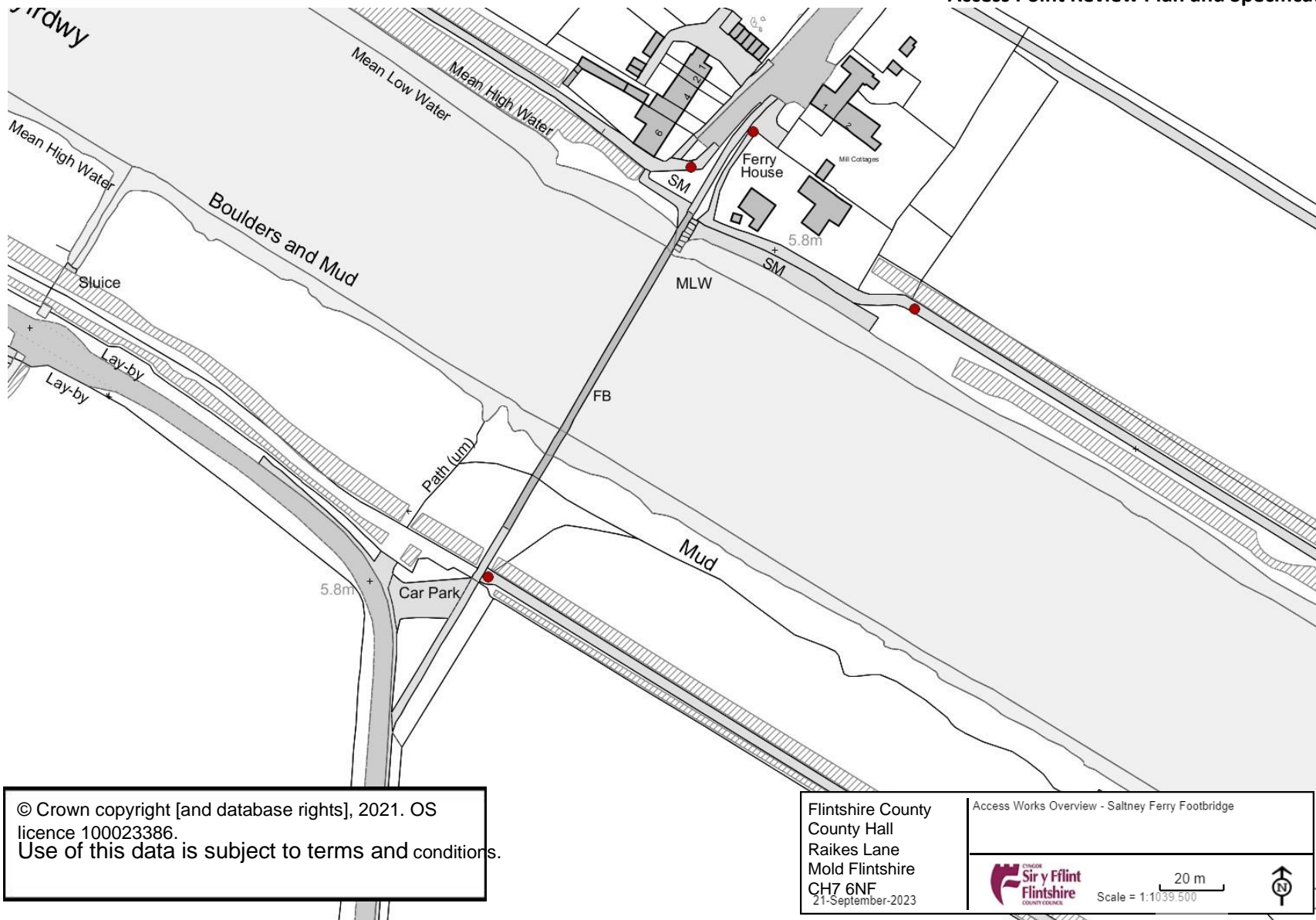

© Crown copyright [and database rights], 2021. OS  
 licence 100023386.  
 Use of this data is subject to terms and conditions.

Flintshire County  
 County Hall  
 Raikes Lane  
 Mold Flintshire  
 CH7 6NF  
 21-September-2023

Access Works Overview - Saltney Ferry Footbridge



Scale = 1:1039.500



Map 1 – Overview of work locations.

Tudalen 400

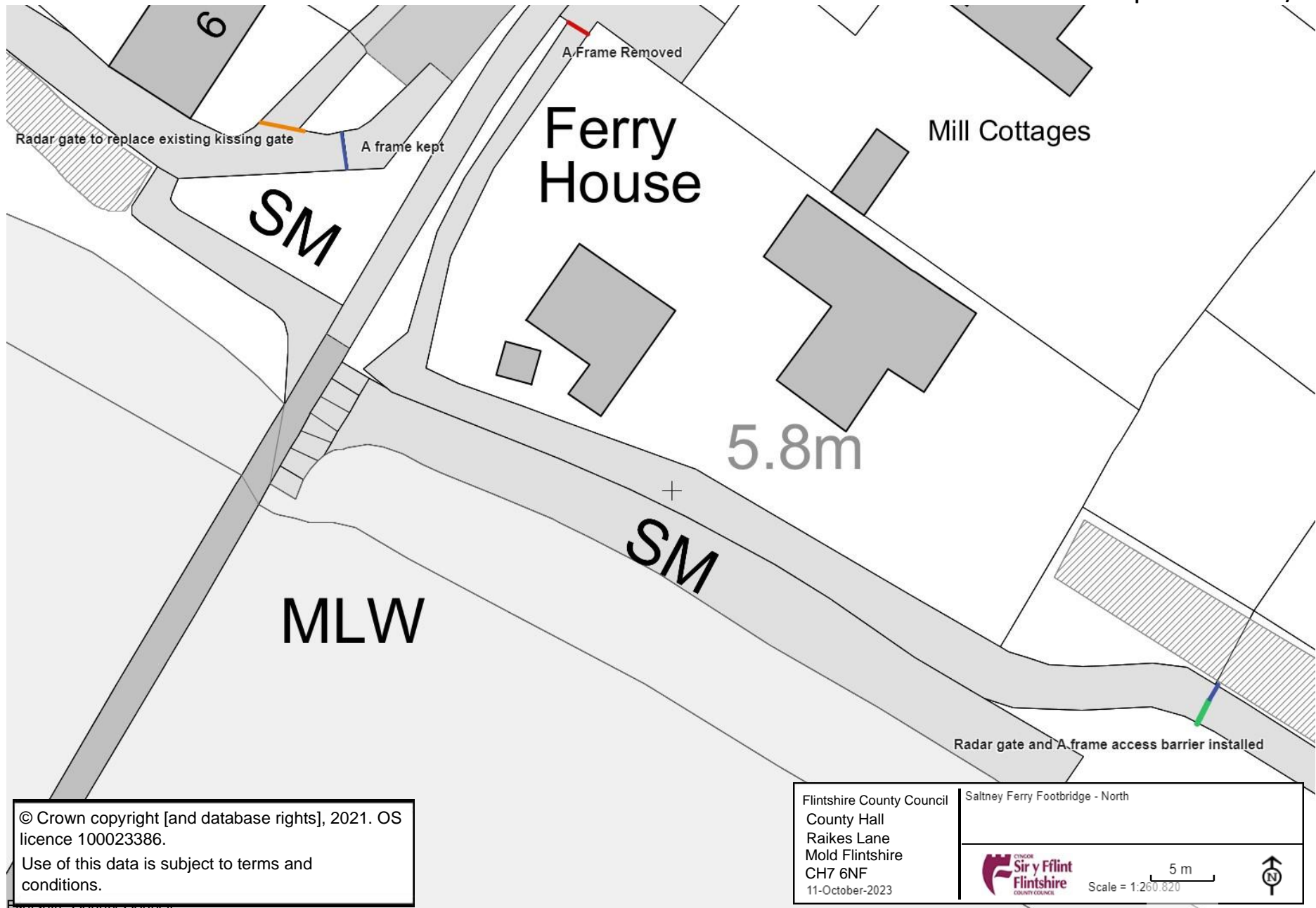



Map 2. Proposed works Saltney Ferry North

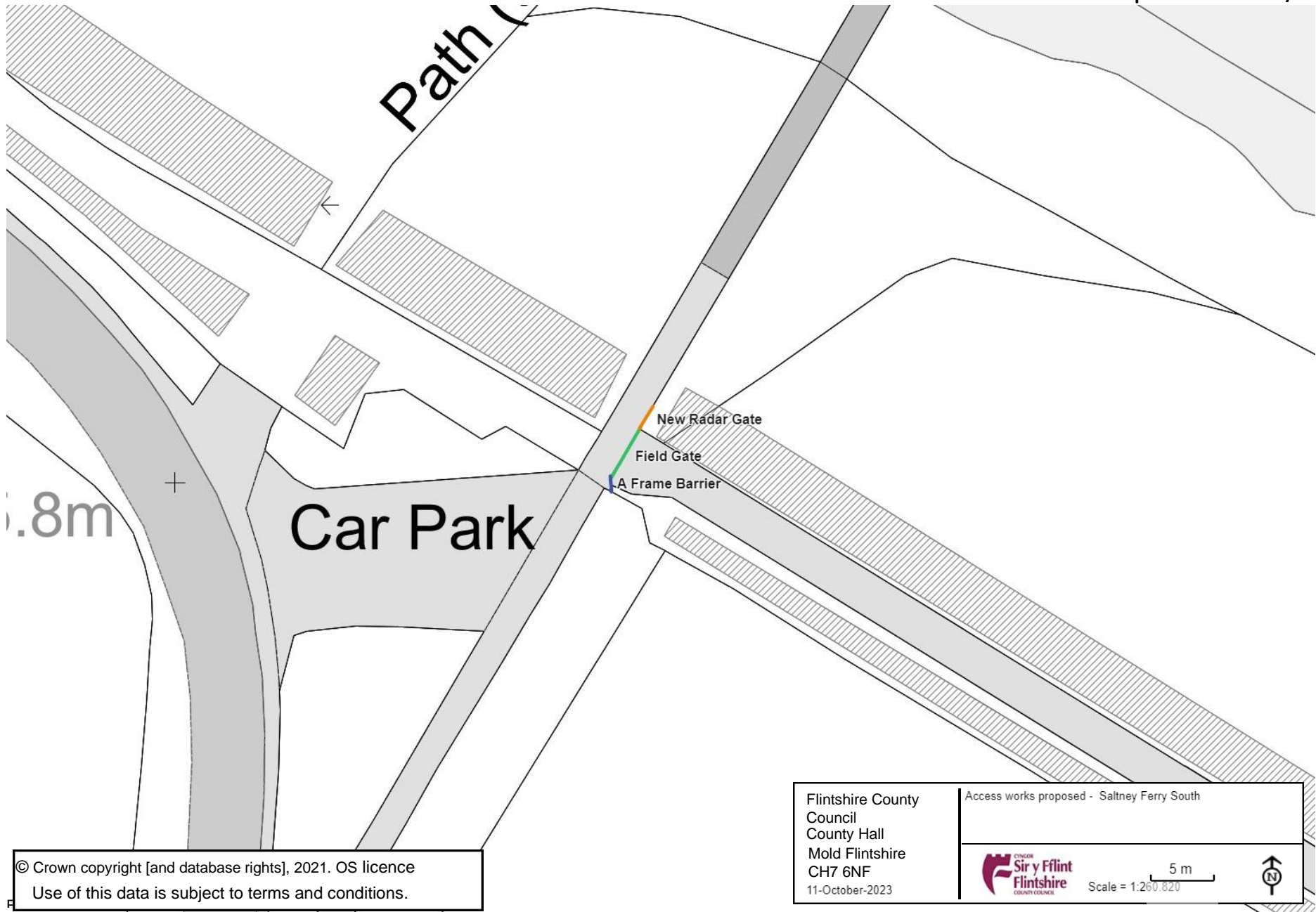

Tudalen 401



© Crown copyright [and database rights], 2021. OS licence  
 Use of this data is subject to terms and conditions.

<p>Flintshire County Council          County Hall          Mold Flintshire          CH7 6NF          11-October-2023</p>	<p>Access works proposed - Saltney Ferry South</p>  <p>Scale = 1:260 820</p> 
--	---

**Map 3. Proposed works Saltney Ferry South**

**Radars Gate Specification**

F010 2002 12



ITEM NO.	PART NUMBER	DESCRIPTION	QTY.
1	D010 2001 16	1500X1750 MARLOW 2 WAY GATE 'H' FRAME	1
2	D010 2001 14	1.2 PRT/MSH 2WAY MARLOW GATE C/W RADLOCK	1
3	B104 1220 42	M20X6in EYEBOLT GALV	1
4	F010 2002 54	MARLOW RADLOCK SLIDING BOLT	1
5	B001 3080 20	M8 X 20 SETSCREW BZP	2
6	B040 3002 08	M8 FULL NYLOC NUT TYPE T BZP	2
7	B003 2200 90	M20X90 BOLT GLV	1
8	B040 2002 20	M20 NYLOC NUT TYPE T	1
9	B106 0001 01	GATE CATCH PAWL (BARREL TYPE) GLV	1
10	B001 2080 30	M8 X 30 SETSCREW GALV	1
11	B040 2002 08	M8 FULL NYLOC NUT TYPE T GLV	1
12	B113 0005 01	RADAR PADLOCK TYPE A (2 LEVER) GALV	1
13	B051 3050 32	3/16 X 1 1/4in SELLOC PIN BZP	1
14	B111 0020 10	BADGE "CENTREWIRE" (50X20MM)	1
15	B117 8233 01	120 X 30 X 3mm BUTYL RUBBER STRIP	1
16	B021 3550 00	G16 BONDED WASHER (5.5mm DRILL SCREW)	2
17	B052 3148 11	4.8X12 LARGE FLANGE STEEL RIVET 1-6MM	2
18	B052 4032 08	3.2X8MM ALUMINIUM BLIND (POP) RIVET	2

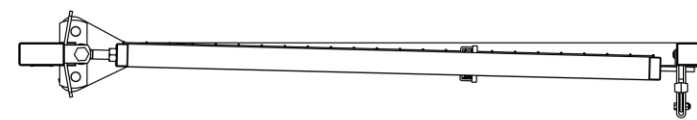
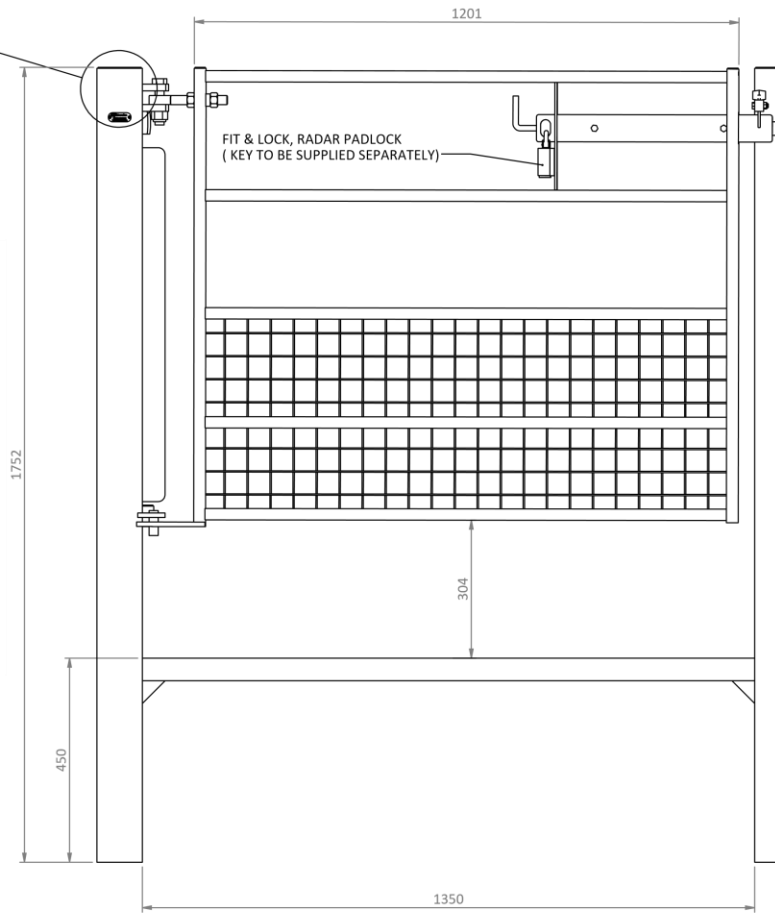
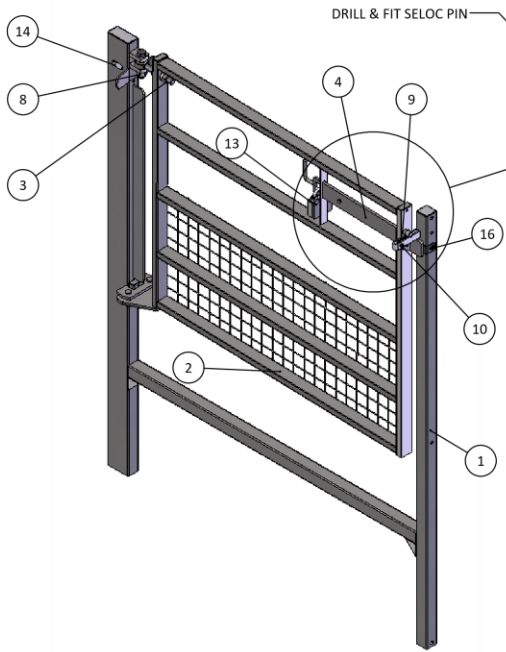
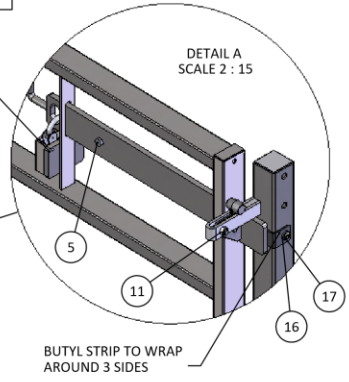
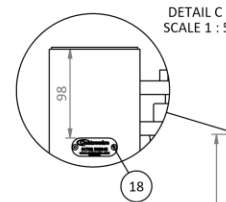

Tudalen 402

TITLE 1.2 PRT/MSH 2WAY MARLOW GATE C/W RADLOCK

PART No. F010 2002 12 Rev. A

THE INFORMATION CONTAINED IN THIS DRAWING IS THE PROPERTY OF "IAE". COPYRIGHT IS RESERVED BY THEM AND THE CONTENT USED ON THE CONDITION THAT IT IS NOT COPIED, REPRODUCED, RETAINED OR DISCLOSED TO ANY UNAUTHORISED PERSON EITHER WHOLLY OR IN PART WITHOUT THE CONSENT IN WRITING OF "IAE".

GENERAL NOTES		GENERAL TOLERANCES (UNLESS OTHERWISE STATED)	
1.REMOVE ALL BURRS & SHARP EDGES		BOUGHT IN	
2.ALL THREADS TO BE ISO METRIC COARSE		MADE IN HOUSE	
WELDING NOTES		REFER TO IAE TOLERANCE STDS	
1.FULLY WELD (UNLESS OTHERWISE STATED)		ANGULAR +/- 0.5°	
2.ALL WELDS TO BE FREE OF SPIKES & SPATTER		ALL DIMENSIONS ARE IN MILLIMETRES	
MATERIAL	Material <not specified>	A3	SCALE 1:20 DO NOT SCALE
FINISH	HOT DIP GALV	DRAWN	martinf
EST.NATURAL WEIGHT(kg.)	47.60	DATE	24/02/2011
		SHEET	1 OF 1
			IF IN DOUBT - ASK!

A	FIRST ISSUE	MM	24/10/2011
REV	DESCRIPTION	ECR	INT DATE

Tudalen 403

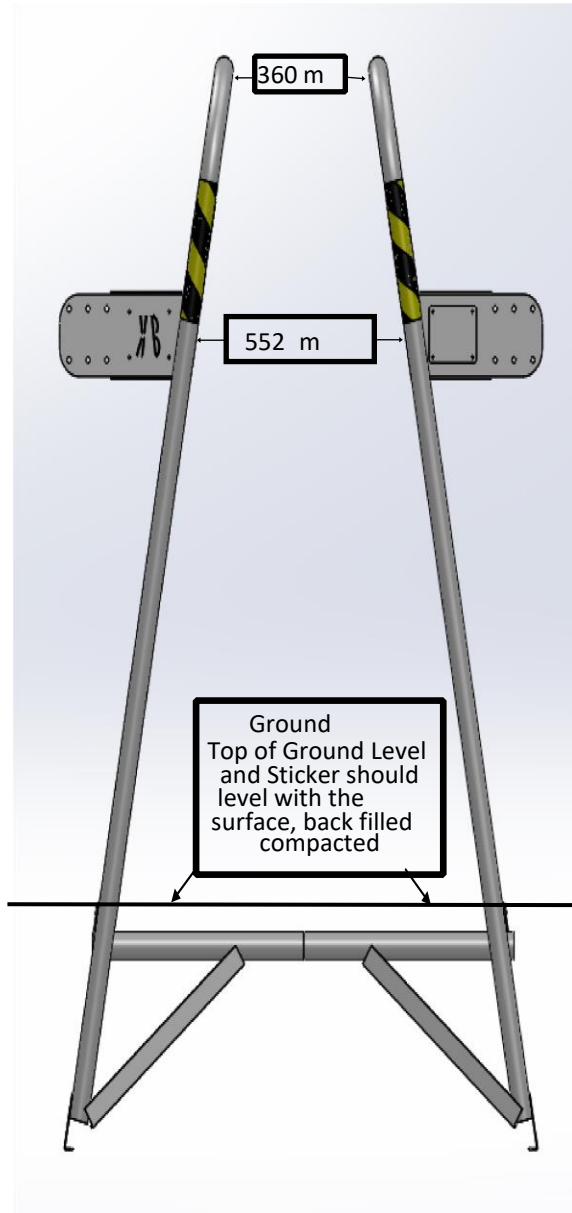

Mae'r dudalen hon yn wag yn bwrpasol

## Feedback summary in response to the proposed access improvements in Saltney Footbridge Area

### Suitability of radar locks

It was noted that some disabled people such as those with motor neuron difficulties and amputees may not be able to open the lock. It was also stated that Radar locks are not accessible to the majority of disabled users.

### Gap width

It was highlighted that the width of the proposed A frame restricts movement of larger mobility aids through them. A request was made to install the most accessible A frames.

There are suppliers of A frames that can be installed with a different gap width, widening the gap would also allow motorbike access.

One user stated that his tricycle has a track width of 780mm and overall width of 830mm and a wider rickshaw type bike was also used with a width of 900mm and a length of 2300mm.

Respondents highlighted that the minimum width permitted at physical constraints is 1.5m within the Active Travel Guidance. Comments also highlighted the need for a 4m minimum external turning radius, 10kph minimum design speed for the Cycle Design Vehicle (rigid quad cycle 2.8m long by 1.2m wide)

It was requested the removal of all A frames from designs and all closing gates including RADAR locking gates from designs, except for existing vehicle access gates where these can be retained.

It was requested that locking bollards spaced with minimum 1.5m air gaps and straight approaches where vehicle access needs to be maintained were installed.

### Unauthorised Use by Vehicles

Concerns were raised that unauthorised vehicle users will also be able to gain access through the radar gates. Radar keys are easily purchased over the internet and therefore pose the risk that unauthorised vehicles will be able to use them.

It was suggested that CCTV is used at known access points and liaison with local police to establish monitoring and enforcement and signage to promote considerate shared use.

It was also commented that there was open access in this area from Bumpers Lane and Sealand Road at the other end of the path making the proposal ineffective in controlling unauthorised use by vehicles.

One response noted that as far as they were aware, the replacement of the old barriers at the Mickle Trafford end of the Millennium Greenway has not led to an increase in Motorcycle use.

### **Path Safety**

Local members felt that the proposals would result in improving access whilst also providing a level of control on unauthorised use by motorbikes. Safety concerns were highlighted regarding the speed of electric bikes travelling along the path.

### **Landscape Impact**

Concerns were raised about the impact on the new structures on the skyline.

### **Equalities Act 2010**

Respondents felt that the proposals was in breach the [Equality Act \(2010\)](#) and may give rise to discrimination claims. Legal action has been started against Newcastle City Council by the owner of a recumbent bike as he is unable to get through the chicanes installed to prevent unauthorised motorbike accesses on a cycle path.

### **Future Funding Impact**

Transport for Wales (who award Active Travel Transport Grant on the Welsh Government's behalf) have indicated that by having barriers that do not conform to the Active Travel Act or the Equalities Act, future funding for Active Travel within the county could be jeopardised.

### Specific Feedback received to the Access Improvements in the Saltney Footbridge Area

Respondent 1	<p>What types of disabled access are radar keys usually used for ...? My experience of them is for accessible toilets which are able to be opened one handed with a radar key. I am concerned that what you are proposing will be difficult for anyone with motor skills issues.</p> <p>Also re the current A frames, which we all know are not best practice in terms of size (if they were, we wouldn't be where we are now), why aren't you fitting the most accessible ones that you can rather than replacing like for like?</p> <p>Re asb, I think you may be under estimating those who indulge in asb ..... what have the police said re radar key access to stop asb? Ironically that cohort of users will probably be quicker through the access than I will be!!</p> <p>Re this work, are you actually listening to any users with disabilities and working closely with them to ensure that precious public money actually makes a difference here?</p> <p>What testing of equipment has been done with disabled users to ensure that what is proposed is fit for purpose?</p> <p>Although I have been talking to various people in Flintshire for the last 3 years, it does not feel like people are really listening .....</p>
Respondent 1 – questions	<ul style="list-style-type: none"> <li>• can the radar key gates be unlocked by a person with one hand?</li> <li>• is the radar gate wide enough for a trike to pass through?</li> <li>• it looks like there is a lip to get over on the radar gate design eg a lower bar across, is that correct?</li> <li>• is it step free access through the radar gates?</li> <li>• what if asb users have radar keys which are readily available?</li> <li>• are the new A frames wider than the current ones?</li> </ul>
Respondent 2	<p>Out of medical necessity I am now a tricycle rider in the 60+ age demographic.</p> <p>I cannot gain passage through the A frame barriers at Saltney Ferry bridge or immediately adjacent at either side of Ferry Lane.</p> <p>My tricycle has a track width of 780mm and overall width of 830mm.</p> <p>My disabled wife and I also use a a tricycle best described as rickshaw like, its width is even wider at 900mm and 2300mm length meaning that passage through both the various A frames and chicanes on route is equally not possible. The turning circle</p>

	<p>of closely set together chicanes is the problem. Handling of the trike is not possible given it is just shy of 60kg without my wife passenger.</p> <p>I would welcome any solution that provides passage through these many obstacles, upon the path and via the access points onto the Wales coast path alongside the River Dee linking to the Greenway.</p> <p>I enclose three images of my tricycle at the A frame unable to leave the path at Ferry Lane from Hawarden bridge direction.</p>
Respondent 3	<p>I have looked at the amendments to the A frame and radar gates but can't find any significant change to the height and width of the A frame to allow access for all terrain wheelchairs and mobility scooters most suitable for the outdoors. I did talk about the issues disabled people have managing radar locks and have attached the detailed information I sent to Tom Woodall. I have asked other disabled groups such as wheels for all to send comments to you directly.</p> <p>Info and resources I have gathered with regards response to the barriers review report.</p> <p>Design Guidance and recommendations from several sources including Active travel Wales, the DDA, Equality act, Sustrans, disabled cyclists and groups (Wheels for Wellbeing and Chester cycling campaign access officer) providing evidence and reasons to show : *Radar gate locks are not accessible for the majority of disabled cyclists and mobility aid users.</p> <p>* Staggered gates must be fitted to minimum requirements for turning radius using a swept analysis.</p> <p>*The type of bollard to use, but ONLY when proved absolutely necessary, to prevent motor vehicle access.</p> <p>Key points</p> <ol style="list-style-type: none"> <li>1. A swept path analysis is required with 4m minimum external turning radius, 10kph minimum design speed for the Cycle Design Vehicle (rigid quad cycle 2.8m long by 1.2m wide) for any proposed barriers to be installed or altered.</li> <li>2 Many Disabled people aren't able to use Radar locks due to limb deformities, amputations, restricted movement which makes any kind of gate or lock inaccessible to a significant proportion of Disabled people, and is therefore discriminatory</li> <li>3 Radar keys are available on the internet, anyone can buy them and radar gates would be open to abuse.</li> </ol>



4 All of the A frames and barriers listed in the report are identified as being below the compliance standards measurements recommended by Sustrans and have potential to disadvantage disabled users according to the Equality act.

5 Any cyclist who is not disabled using a larger bike with panniers, basket or trailer etc is at present unable to fit through the A frames (which measure 900mm) without difficulty because they are below minimum standard widths of 1.5 so they are causing major obstruction to many people.

Attached are the guidance sheets provided by Wheels for wellbeing, the London disabled cycling group who emphasise - 'installing barriers of any kind in narrow locations is not a user safety measure – it's dangerous to obstruct access in an isolated location and at a point where Disabled users are unlikely to be able to turn around should they be unable to get through the barrier that may already be restricted by broken glass, fallen branches etc. – obstructing narrow access points is really dangerous !

Staggered gates are absolutely not in line with LTN 1/20 or Welsh guidance. They will definitely be inaccessible to a significant proportion of potential path users. The only barrier they could use would be paired bollards, and ONLY where prevention of cars and larger vehicles entering a space is required.

Guidance from the Welsh Active Travel [https://www.gov.wales/sites/default/files/consultations/2020-02/active-travel-guidance\\_1.pdf](https://www.gov.wales/sites/default/files/consultations/2020-02/active-travel-guidance_1.pdf) :

12.12.5 "...any one-way cycle lane or track should be at least 1.5m wide, or it will risk excluding some types of user. The use of chicanes or gates aimed at restricting unauthorised access to paths (e.g. by motorcycles) may also obstruct these users, and therefore must not be used unless in EXCEPTIONAL circumstances."

12.18.4 "A minimum width of 1.5m is required between bollards, chicane barriers or at gates to accommodate the full range of cycles and mobility scooters. Kissing gates should not be used on cycle tracks."

14.36.6 "Restrictive access controls, vegetation growth that encroaches on the track surface, poor or inadequate lighting, poor sightlines or poorly maintained track surfaces will deter users"

18.12.4 "A single bollard, and clear sight lines will be effective in many locations. Double rows of bollards, with a minimum spacing of 1.50m can reduce cycle speeds and prevent motor vehicle access, whilst retaining better permeability for users than chicane barriers."

Minimum turning circles radii are given in table 3-3 with 3.4m minimum external turning radius.

	<p>To conclude Minimum clear straight-line access widths at access controls are 1.5m in England and Wales</p> <p>A simple and effective solution is to replace vehicle access gates (where these are present) with lockable bollards spaced with min 1.5m air gaps to allow emergency, maintenance and special access.</p> <p>Bollards below 1.65m will stop any modern car (that's the axle width of a Smart car). Most cars will be unable to get through a gap less than 1.8m. Larger SUVs etc are over 2m wide.</p> <p>Signage is required regarding rules of shared path use, speed, illegal vehicle access, penalties. Path users can help by reporting if they see anti social.</p>
Respondent 4	<p>I have seen the proposals for modifications to the modifications to access to and from the cycle path at Saltney Ferry</p> <p>Whilst I welcome the removal of one of the A-Frame barriers, I am appalled that the plan is to install another (on the East side of the northern bank of the river). This is contrary to all the guidance embodied in "Gear Change" and LtN 1/20. There seems to be a failure to look at the issues holistically (the existing chicanes on the path which already slow cyclists are not shown) and of keeping 'allowing access for all' in mind..</p> <p>A-Frames are a significant barrier to cyclists, particularly those using non-standard cycles and trikes or pulling a children's trailer or Tag-a-Long. They are also a significant barrier to those or those using mobility aids (trikes and scooters), frequently denying them access altogether.</p> <p>It is not at all clear why these barriers are considered to be necessary – if for the exclusion of motorcycles (the usual reason given) - then it cannot work as there is open access from Bumpers Lane and Sealand Road at the other end of the path. As far as I am aware, the replacement of the old barriers at the Mickle Trafford end of the Millennium Greenway has not led to an increase in Motorcycle use. It is also well documented that the more that such paths are used by walkers and cyclists, the less the likelihood of motor cycle abuse.</p> <p>I hope that the proposal can be redesigned in order to make it more user friendly and to be less discriminatory in terms of access.</p>
Respondent 5	<p>Good idea. Will do. Pleased to see one A-frame removed, which has caused me problems with the trailer before (it did just about fit through with some cajoling).</p>

	<p>However, as the proposed new A-frame in the other location is to be 360 metres wide at its narrowest point, I think most bikes should be able to get through fine. We should probably be concerned about the impact of this structure on the skyline.</p>
Respondent 6	<p>One of our supporters has brought your Wales Coast Path scheme designs to our attention. We are very disappointed and concerned to see that your designs include the installation and retention of A frames and RADAR gates. These barriers will be impassable for many Disabled cyclists, users of mobility scooters, wheelchair users and others using larger cycles such as family cycles or cargo trikes. The installation and retention of these barriers is likely to breach the <a href="#">Equality Act (2010)</a> and may give rise to successful discrimination claims.</p> <p>Please see the following guidance sheets Wheels for Wellbeing have produced to help authorities understand the reasons these barriers are discriminatory, and to provide alternative options to ensure equitable access to active travel:  <a href="#">Guide to inaccessible barriers</a>  <a href="#">Guide to RADAR locking barriers</a>  <a href="#">Guide to vehicle access restriction bollards</a></p> <p>The <a href="#">Welsh Active Travel Guidance 2022</a> is clear that the barriers you propose to install will prevent access by Disabled people. It appears entirely unreasonable to us to consider large stretches of national active travel infrastructure as “exceptional circumstances” where preventing Disabled access to an important traffic-free route is an acceptable response to concerns about use by motorcycles and quad cycles. From the Welsh active travel guidance:  9.3.2 “Disabled people may need to use mobility scooters, wheelchairs, adapted or nonstandard cycles (such as tricycles, quadricycles or hand cycles), which require the careful design of facilities to make sure that their greater width and turning space requirements can be accommodated.”  9.3.4 “Disabled people are not a homogenous group, and it is important that the full range of diverse needs is considered and accounted for in the design process.”  9.9.2 “Designs should meet the needs of everyone who cycles at any age or physical condition. Cycle routes should cater for a wide spectrum of people with different levels of confidence and experience; and those who use adapted cycles (see section 9.3 and figure 9.4).”  Table 9.8 shows absolute minimum widths permitted at physical constraints are 1.5m. Since many Disabled people cannot open gates and pass through them with their mobility aid, all gates which must be opened manually therefore can be considered as having a minimum width of 0m.  9.17.10 “A minimum width of 1.5m is required between bollards, chicane barriers or at gates to accommodate the full range of cycles. Gates should be avoided on cycle routes and ‘kissing gates’ must not be used.”  15.3.2 “Designers should start with a presumption against the use of any form of access control, installing only in response to evidence of actual problems of abuse of cycle</p>

and pedestrian facilities, and never simply in response to perceived problems.”

15.3.3 “Access controls can cause difficulties to many legitimate users and can render routes inaccessible to people who rely on mobility aids.”

15.3.5 “A single bollard, and clear sight lines will be effective in many locations”

Minimum turning circles radii are given in table 9.3, with 3.4m minimum external turning radius to provide access for the Cycle Design Vehicle, which is 2.8m long and 1.2m wide.

Inaccessible barriers which make access to public spaces (including cycle paths and footways) more difficult for Disabled people than non-Disabled people are discriminatory under the Equality Act (2010).

The Equality Act requires public authorities including councils to alter and remove physical features which would otherwise exclude or significantly disadvantage Disabled people (Section 20) and to advance equality of opportunity for Disabled people by actively enabling Disabled people to participate in public life and activities (Section 149, Public Sector Equality Duty).

There is a risk of successful discrimination claims being made against Flintshire County Council under the provisions of the Equality Act (2010) if active travel routes are inaccessible, even if causing or retaining inaccessibility was not the intention of this project.

However, it will be not be difficult or have significant cost implications to remedy the situation at this stage. We suggest that to be fully compliant with the Equality Act (2010) and Welsh active travel infrastructure guidance if the following action is taken:

1. Alter designs to ensure clear straight-line access of minimum 1.5m at all proposed vehicle access restriction locations.

a. Remove all A frames from designs;

b. Remove all closing gates including RADAR locking gates from designs, except for existing vehicle access gates where these can be retained

while enabling sufficient straight-line cycle access;

c. Install locking bollards spaced with minimum 1.5m air gaps and straight approaches where vehicle access needs to be maintained.

2. Where there is a history or significant risk of inconsiderate path use, consider adding signage to encourage considerate shared use, for example

“pedestrian priority, cycles slow” and “please keep dogs on short leads”.

3. Where there is a significant history of illegal path use including by motorised vehicles, liaise with local police to establish monitoring and enforcement options, including use of CCTV at known access points.

We would be grateful if you could respond to us indicating that you will alter your designs to enable equitable access for Disabled path users, including a timescale by which these alterations will take place.

We would appreciate you sharing your designs with us, so that we can ensure Disabled people living in and visiting Flintshire will be able to enjoy your active travel routes equitably.

Respondent 7	This will hopefully be an improvement to allow disabled access and prevent the use of motor bikes. Not sure, but will it stop that electric bike that's travels at 40/50 mph down the pedestrian cycle path?
Respondent 8	This looks like an improvement.
Respondent 9	<p>Further to the email below and our team's concerns around potential reputational damage for the Authority as a result of the barriers, I thought it might be useful to let you know about this recent legal challenge against Newcastle City Council as it would appear to be a situation that we could possibly find ourselves in.</p> <p>We would welcome an opportunity to discuss Fiona's and our team's concerns and have the opportunity to have an input into your recommendations to Members.</p> <p><a href="https://www.google.com/amp/s/www.bbc.com/news/uk-england-tyne-66818217.amp">https://www.google.com/amp/s/www.bbc.com/news/uk-england-tyne-66818217.amp</a></p> <p><i>As a result of campaign groups escalating the issue with the barriers, TfW (who award Active Travel Transport Grant on the Welsh Government's behalf) have been in touch to say that, by having barriers that do not conform to the Active Travel Act or the Equalities Act, we could jeopardise future funding for Active Travel. Their comments can be seen in the extract below.</i></p> <p><b>Access Barriers</b>  <i>Just wanted to flag an early risk in relation to Active Travel Fund support on routes which include non-compliant access barriers, as appreciate these are in place on a number of routes on Flintshire's Active Travel Network Map of future aspirations - which might otherwise be eligible for capital funding support through the programme.</i></p> <p><i>The funding guidance states: Funding for active travel schemes will only be granted where scheme design reflects the <a href="#">Active Travel Act Guidance</a>.</i></p> <p><i>Section 15.3 of the Active Travel Act Guidance <a href="#">Active Travel Act guidance (gov.wales)</a> covers advice in relation access controls.</i></p> <p><i>As an example, the current frames in place on sections of the proposed network (such as those in and around the Deeside area) do not comply with the guidance, as they would prevent legitimate users of certain cycles (e.g. cargo, adapted, recumbent) and users of certain mobility aids (e.g. mobility scooters, certain wheelchairs) from accessing the route.</i></p> <p><i>Further advice on design considerations is available here: <a href="#">Sustrans greenways design guide: 9. Accessibility to routes - Sustrans.org.uk</a></i></p>

	<p><i>And case studies relating to the some of the issues they cause to legitimate users (and risks to the local authority in relation to duties under the Equality Act 2010) available here:</i></p> <p><a href="#">Why barriers on cycle routes stop me from cycling independently: Amanda's story - YouTube</a>  <a href="#">Barriers on cycle paths   Cycling UK</a></p> <p><i>Just a final note as a reminder that the current ATF grant advice states applications can be made for use of the core allocation for removal or redesign of non-compliant access barriers (Annex 3).</i></p>
Respondent 10	<p>We have been made aware you are currently planning changes to access controls in several locations along the All Wales Coastal Path and NCN Route 5 in Deeside and note the cabinet decision to approve RADAR gates and chicanes, retaining the existing extremely restrictive A frames.</p> <p>We are of the view from many years of experience with developing and maintaining the NCN across the UK that these types of barriers simply exclude many legitimate users, especially those in mobility scooters and using adapted or non-standard cycles, whilst having a very limited effect in preventing anti-social behaviour, particularly from motorbikes, given the ability for these to find alternative access points and does nothing to address this behaviour at source. Larger vehicles can be prevented from access through agreed designs, such as bollards or very wide chicanes which would be compliant with current guidance.</p> <p>Whilst RADAR gates might seem an effective solution for those with disabilities, we know that many disabled people cannot use them effectively and any need to open multiple gates along a relative short stretch of route will deter all but the most determined users from accessing the path, whilst actively restricting the ability for the path to cater for a wider range of users particularly local residents and tourists. The message this sends is plainly wrong and does nothing to attract visitors to the area, or those accessing the route without extensively planning their journey first.</p> <p>Wheels for Wellbeing, an organisation specifically supporting wheeled users with disabilities has issued guidance on RADAR gates <a href="#">ICI Guide</a> which makes their position clear.</p> <p>Further, we have doubts if the radar key operated gates proposed are compliant with the Equality Act, and we are not aware that an equality impact assessment has been carried out for these sites. If complaints are received and upheld, we believe that Flintshire County Council may face a further financial liability. For example, in the past year, we are aware that RADAR key operated gates have been replaced by Natural Resources Wales due to a single complaint about access for one specific type of mobility scooter.</p> <p>We are disappointed that Sustrans was not consulted at an earlier stage, before the “Access Barrier Review – Wales Coast Path” report was considered by Cabinet on 18th July 2023. We founded and are the custodians of the National Cycle Network, receive funding from the Welsh Government to maintain and improve it and, following an audit of all access controls on the National Cycle Network in Wales completed last year, our assessment information on access controls forms the basis of the Welsh Government’s Active Travel Act Guidance.</p>

	<p>Several Local Authorities in Wales have already acted on this guidance and removed or amended many access controls on the NCN in their areas to make the network much more accessible to all users. This is a far more inclusive approach and has proved that barriers can be removed without any significant adverse effects from greater levels of anti-social behaviour.</p> <p>We strongly urge that in the future, Sustrans must be offered the opportunity to bring our considerable expertise on access controls to the process, or at the very least be consulted at an early stage, on all active travel routes and particularly along the coastal National Cycle Network in Flintshire.”</p> <p>I trust the above makes Sustrans’ position clear. We would be happy to engage further on the matter if this would be helpful.</p>
Respondent 11	<p>I have significant concerns regarding the removal of the barriers however I understand the need to adjust. My concerns are for the safety of the public to prevent the use of off road motorbikes along the coastal path. We have seen an increase in county lines (drug selling) along the coast path which we are working on methods to prevent. Also, the barriers are reducing/preventing any accidents by slowing pedal cycles/preventing motor bikes from accessing the area. Therefore, I am requesting that they are not removed and that they are adjusted to enable any disability groups access to the coastal path but also stopping any illegal bikes.</p>

Mae'r dudalen hon yn wag yn bwrpasol



# Equality Impact Assessment (EqIA) (including Welsh Language & Socio-economic Duty)

November 2021

<b>Name of Policy or Practice</b>	Access barrier improvements – Saltney footbridge access to Wales Coast Path		
<b>Responsible Officer / Head of Department</b> (responsible for the Policy or Practice)	Andrew Farrow, Chief Officer for Planning, Environment and Economy		
<b>Service / Department</b>	Planning, Environment and Economy	<b>Start Date of Assessment</b>	1 <sup>st</sup> November 2023

<b>Name of officer(s) (and partners) completing the EqIA</b>		
<b>Name(s)</b>	<b>Job Title(s)</b>	<b>Signature(s)</b>
Tom Woodall	Access & Natural Environment Manager	
Helen Mrowiec	Sites Team Leader	

\*Consider including only job titles when publishing

<b>Document Version</b>	<b>Revision Date</b>	<b>Briefly Describe the Changes</b>

<b>EqIA Approved by Responsible Officer / Head of Department / Service / Committee</b>	
<b>Date EqIA Concluded</b>	
<b>Name</b>	
<b>Job Title</b>	

--	--	--

<b>Signature</b>	
------------------	--

## Introduction

This document is a multi-purpose tool ensuring the appropriate steps are taken to comply with the [Public Sector Equality Duty](#) Equality Impact Assessment legislation and to demonstrate that we have shown due regard to the need to reduce inequalities of outcome resulting from socio-economic disadvantage when taking strategic decisions under the [Socio-economic Duty](#) It also ensures that we take appropriate steps to comply with the requirements of the [Welsh Language Standards](#) (Section 44: Welsh Language Measure (Wales) 2011) to consider the impact of strategic and policy decisions on the language.

When we plan to introduce a new, or revise an existing, policy or practice, make changes or cuts to a service or make strategic decisions, we are required to consider if the decision would have a disproportionate impact on people sharing one or more [protected characteristic](#) or whether it could create inequalities of outcome around socio-economic disadvantage. Where this is likely to be the case, we must take appropriate action. The EqIA process is not intended to prevent us doing things but to ensure we have considered the impact. It helps us focus on the actions we can take to remove and/or mitigate any disproportionate or discriminatory impact and introduce measures to advance equality of opportunity.

To comply with the [General Duty](#) and [Socio-economic Duty](#), we must have 'due regard' (or consciously consider the need) to: eliminate discrimination, advance equality of opportunity and foster good relations and to the need to reduce the inequalities of outcome resulting from socio-economic disadvantage. The greater the relevance and potential impact, the higher the regard required by the duty. The General Duty will be more relevant to some functions than others and they may also be more relevant to some protected characteristics than others. Our duty must be exercised with rigour, an open mind and considered at a time when it can make a difference to our decisions. Policies with high relevance, such as strategic budgetary decisions, grant-making programmes, changes to service delivery (including withdrawal or reorganisation of services), and recruitment or pay policies should always be subject to an assessment for impact. For further guidance see [EHRC Assessing Impact Guidance](#) and [Socio-economic Duty Code of Practice](#). Our duty to comply with this legislation cannot be delegated.

This template should demonstrate the steps taken to carry out the assessment including relevant engagement/consultation, the information taken into account, the results of the assessment and any decisions taken in relation to those results. The EqIA should be published where it shows a substantial (or likely) impact on our ability to meet the General Duty.

### Benefits of undertaking an EqIA:

- Gain a better understanding of those who may be impacted by the policy or practice
- Better meet differing needs and become more accessible and inclusive
- Enable planning for success – identifies potential pitfalls and unintended consequences before any damage is done
- Enable improved planning that will make decisions proactive rather than reactive, avoid having to reverse decisions which could have cost and reputational implications

- Demonstrate decisions are thought through and have taken into account the views of those affected
- Enable us to manage expectations by explaining the limitations within which we are working (eg, budget)
- Help avoid risks and improve outcomes for individuals
- Remove inappropriate or harmful practices and eliminate institutional discrimination
- Ensure we put Welsh and English Language on an equal footing and that decisions are made that safeguard and promote the use of the Welsh language

Whilst this document may seem lengthy, as well as containing the necessary steps in the process, it also contains guidance notes in the key areas to assist you in undertaking the EqIA. Additional links to further information are also included for assistance. Further information can be found on NHS/ WLGA PSED/ EIA [here](#).

## Equality and Welsh Language Impact Assessment Steps

- Step 1 - Identify the Main Aims and Objectives of the Policy or Practice
- Step 2 - Data, Engagement and Assessing the Impact
- Step 3 - Procurement and Partnerships
- Step 4 - Dealing with Adverse or Unlawful Impact and Strengthening the Policy or Practice
- Step 5 - Decision to Proceed
- Step 6 - Actions and Arrangements for Monitoring Outcomes and Reviewing Data
- Step 7 - Publishing the Equality Impact Assessment

### Important Note to Completing Officer(s):

It is important that the EqIA is completed when the policy or practice is being developed so that the findings from the EqIA can be used to influence and shape the policy or practice. It is recommended as a minimum, it is completed by a lead officer who is responsible for the policy or practice, a subject matter expert and a critical friend with at least one who has received formal EqIA training. This document needs to be presented to the decision makers along with the draft policy or practice as part of the decision making process.

Where you are developing a high level strategy or plan that does not contain sufficient detail to show how it will impact on individuals or groups (ie, where there will be plans and actions sitting beneath the strategy that will determine this), you should still undertake the full Equality Impact Assessment. You may also need to complete additional EqIA(s) on the plans and actions beneath the high level strategy. This will ensure you demonstrate that you have shown due regard to complying with the [General Duty](#), the [Public Sector Equality Duty](#), the [Welsh Language Standards](#) and the [Socio-economic Duty](#).

If your policy or practice is as a result of a UK, Welsh Government or Local Authority wide directive, you should still assess the impact of this locally to identify any differential impact due to local difference.

You should consider whether other events, eg, Covid-19, Brexit, Black Lives Matter, etc, have highlighted or exacerbated inequalities that need to be addressed as you work through the EqIA

## STEP 1 – Identify the Main Aims and Objectives of the Policy or Practice

### 1. What is being assessed? (Please double click on the relevant box(es) (X) and select 'checked' as appropriate)

- New and revised policies, practices or procedures (which modify service delivery or employment practices)
- Service review or re-organisation proposals which affect the community and/or staff, eg, early years provision, care, education
- Efficiency or saving proposals, eg, resulting in a change in community facilities, activities, support or employment opportunities
- Setting budget allocations for new financial year and strategic financial planning
- Decisions affecting service users, employees or the wider community including (de)commissioning or revised services
- New project proposals affecting staff, communities or accessibility to the built environment, eg, new construction work or adaptations to existing buildings, moving to on-line services, self-service, changing location
- Large Scale Public Events
- Local implementation of National Strategy/Plans/Legislation (refer to any national EqIA and consider local impact)
- Strategic directive and intent, including those developed at Regional Partnership Boards and Public Service Boards which impact on a public bodies functions
- Medium to long term plans (for example, corporate plans, development plans, service delivery and improvement plans)
- Setting objectives (for example, well-being objectives, equality objectives, Welsh language strategy)
- Major procurement and commissioning decisions
- Decisions that affect the ability (including external partners) to offer Welsh language opportunities and services
- Other please explain in the box below:

### 2. What are the overall aims, objectives and intended outcomes of the policy or practice?

To improve accessibility to the Wales Coast Path in the Saltney footbridge area.

### 3. Who are the main consultative groups (stakeholders)?

*Note: Consider communities of interest or place (where people are grouped together because of specific characteristics or where they live)*  
Town/Community Council  
County members

North Wales Police (NWP)  
Natural Resources Wales (NRW)  
Sustrans  
Individual service users from the disability sector  
Flintshire Local Access Forum

4. **Is the policy related to, influenced by, or affected by other policies or areas of work (internal or external), eg, strategic EqlAs if this is an operational EqlA and vice versa?**

*Note: Consider this in terms of statutory requirements, local policies, regional (partnership) decisions, national policies, welfare reforms.*

Highways Act 1980  
Wales Coast Path  
Active Travel guidance  
Rights of Way Improvements Plan  
Illegal and antisocial behaviour  
Equalities Act 2010

**STEP 2 - Data, Engagement and Assessing the Impact**

When completing this section, you need to consider if you have sufficient information with which to complete your EqlA, or whether you need to undertake a period of engagement/consultation before continuing. The legislation relating to the EqlA process requires you to **engage and involve people who represent the interests of those who share one or more of the protected characteristics and with those who have an interest in the way you carry out your functions**. The socio-economic duty also requires us to **take into account the voices of those in the community including those with lived experience of socio-economic disadvantage**. You should undertake engagement with communities of interest or communities of place to understand if they are more affected or disadvantaged by your proposals so that you can address inequalities of outcome. This needs to be proportionate to the policy or practice being assessed. Remember that stakeholders can also include our own staff as well as partner organisations.

Before carrying out particular engagement activities, you should first look to data from recent consultations, engagement and research. This could be on a recent related policy or recent assessments undertaken by colleagues or other sources, eg, [Is Wales Fairer?](#), [North Wales Background Data Document](#), InfoBase Cymru, WIMD<sup>1</sup>. This can help to build confidence among groups and communities, who can see that what they have

<sup>1</sup> Wales Index of Multiple Deprivation

said is being acted on. If you have very little or no information from previous engagement that is relevant to this EqIA, you should undertake some engagement work with your stakeholders and with relevant representative groups to ensure that you do not unwittingly overlook the needs of each protected group. It is seldom acceptable to state simply that a policy will universally benefit/disadvantage everyone, and therefore individuals will be affected equally whatever their characteristics. The analysis should be more robust than this, demonstrating consideration of all of the available evidence and addressing any gaps or disparities. Specific steps may be required to address an existing disadvantage or meet different needs.

**The Gunning Principles**, established from past court cases, can be helpful in ensuring we apply fairness in engagement and consultation:

- Principle 1: Consultation must take place when the proposals are still at a formative stage. You must not have already made up your mind.
- Principle 2: Sufficient reasons must be put forward to allow for intelligent consideration and response. Have people been given the information and opportunity to influence?
- Principle 3: Adequate time must be given for consideration and response. Is the consultation long enough bearing in mind the circumstances?
- Principle 4: The product of consultation must be conscientiously taken into account when finalising the decision.

**5. Have you complied with the duty to engage as described above and are you sufficiently informed to proceed?**

Yes  No  *(please cross as appropriate X)*

**If Yes, what engagement activities did you undertake and who with?**

Consultants review of access barriers shared with NWP, NRW, Flintshire Local Access Forum and service users.  
 Specific designs consulted with Service users, Sustrans NRW, NWP and relevant town and community and county councillors

**7. If No, you may wish to consider pausing at this point while you undertake (further) engagement activities which you can include in the action plan below.** Please incorporate any information obtained from this additional activity in the boxes in question 8.

Action	Dates	Timeframe	Lead Responsibility	Information added to EqIA (✓)

Tu 06/10/23 423

--	--	--	--	--

8. **What information do you hold about the impact on each of the following characteristic and statutory considerations / duties from your experience of current service delivery and recent engagement or consultation?** Include any additional relevant data; research and performance management information; surveys; Government, professional body or organisation studies; Census data; Is Wales Fairer? (EHRC<sup>2</sup> data); information from initial screening; complaints/compliments; service user data and feedback; inspections/ audits; socio-economic data including WIMD<sup>3</sup> data. You may wish to include sub-headings showing where each element of your data has come from, eg, national data, local data, organisation data, general or specific engagement exercises, etc. Remember to consider Intersectionality issues, that is, the relationship between overlapping social identities (or socio-economic groups) and protected characteristics.

Consider any positive or negative impact including trends in data, geography (urban or rural issues), demography, access issues, barriers, etc. Also include any areas where there are inequalities of outcome resulting from socio-economic disadvantage or other relevant issues identified by communities of interest or communities of place (ie, where stakeholders, service users, staff, representative bodies, etc. are grouped together because of specific characteristics or where they live) and any issues identified for people living in less favourable social and/or economic circumstances.

Protected Characteristic Group	Relevant Data	Positive and / or Negative Impact	Prompts (not an exhaustive list) <b>Consider:</b>
Race		No impact	How does your proposal take account of: Ethnicity Nationality Gypsies / Travellers Refugee / Asylum Seekers Migrants Barriers to accessing services Cultural issues Dietary requirements Language: interpreter provision Positive Action

<sup>2</sup> Equality and Human Rights Commission

<sup>3</sup> Wales Index of Multiple Deprivation

Tudalen 8



			<p>Co-production  Awareness events  <a href="#">United Nations Convention on the Elimination of All Forms of Racial Discrimination (UNCERD)</a>  Consider intersectionality issues</p>
<p><b>Disability</b></p> <p style="writing-mode: vertical-rl; transform: rotate(180deg);">Tudalen 425</p>	<p>Access Barrier Review Document.</p>	<p>Positive impact of project, although users of some mobility aids will be negatively affected.</p>	<p>How does your proposal take account of the social model of disability?  Consider barriers re  Mobility / Dexterity  Blind or Visually impaired  Deaf or Hearing impaired  Mental Health  Learning difficulties  Dementia  Neurological difference / Autism  Co-production  Barriers to accessing service/ buildings/ facilities  Communication methods  Digital inclusion  Carers  Other Long Term Health Conditions  <a href="#">United Nations Convention on the Rights of Persons with Disabilities (UNCRPD)</a>  Consider intersectionality issues</p>

<p><b>Sex</b></p> <p>Tudalen 426</p>		<p>No impact</p>	<p>How does your proposal take account of Men / Women  Gender Identity  Toilet facilities/baby changing  Childcare  Gender Pay Gap  Sex workers  <u>United Nations Convention on the Elimination of All Forms of Discrimination against Women (UNCEDAW)</u>  Consider intersectionality issues  Co- production</p>
<p><b>Age</b></p> <p>Tudalen 426</p>		<p>No impact</p>	<p>How does your proposal take account of age?  consider  Older People  Children  Young People  Working Age People  Young Families  Demographics  Digital inclusion  Co-production  NB: Where children / young people are affected  complete the <u>Childrens Rights Checklist</u>  <u>United Nations Convention on the Rights of the Child (UNCRC)</u>  Caring responsibilities</p>

			Consider intersectionality issues
<b>Religion &amp; Belief</b>		No impact	How does your proposal take account of religion, belief and non-belief? Consider Faith Communities Non Beliefs Dietary requirements Vegetarianism/Veganism Other philosophical beliefs Dress code/uniforms Religious festivals/activities Co-production Consider intersectionality issues
<b>Sexual Orientation</b> Stordalen 427		No impact	How does your proposal take account of sexual orientation? Gay Lesbian Bi-sexual Heterosexual Terminology Confidentiality about sexuality Consider intersectionality issues Same sex couples Next of Kin Co-production
<b>Gender Reassignment</b>		No impact	How does your proposal take account of the trans community? A person who proposes to,

			<p>starts or has changed their gender identity</p> <p>Transgender</p> <p>Appropriate language use, i.e. appropriate pronouns</p> <p>Gender neutral changing facilities and toilets</p> <p>Gender neutral language within policy</p> <p>Consider intersectionality issues</p> <p>Co-production</p>
<p><b>Marriage &amp; Civil Partnership</b></p>		No Impact	<p>Marital status</p> <p>Civil Partnership status</p> <p>Consider intersectionality issues</p> <p>Co-production</p>
<p><b>Pregnancy &amp; Maternity</b></p>		No impact	<p>Pregnant mothers</p> <p>Those entitled to maternity and paternity leave</p> <p>Foster/Adoption</p> <p>Breastfeeding mothers</p> <p>Gender neutral language within policy</p> <p>Consider intersectionality issues</p>
<p><b>Welsh Language</b></p>		No impact	<p>Ensuring equal status of both Welsh and English languages.</p> <p>Availability of and access to services, activities and information.</p> <p>Technology</p> <p>Rights of individuals to ask for WL services.</p> <p>Impact on Welsh speaking</p>

			<p>communities, including:  Positive / negative effects on opportunities to use the Welsh Language.  Possible changes to number/percentage of Welsh speakers  Migration  Job opportunities / Staffing changes.  Training needs and opportunities  Availability of Welsh medium education  Consider intersectionality issues</p>
<p><b>Socio Economic Considerations</b>  Mynyddalen 429</p>		<p>No impact</p>	<p>People living in less favourable social and economic circumstances than others in the same society. Disadvantage may be exacerbated by many factors of daily life, not just urban or rural boundaries. Consider 'Intersectionality' issues - where identity compounds socio-economic status, e.g. single parents (often women), disabled people, some ethnic minority groups. Consider that the impact can be in a number of domains, for example: Inequalities in Education, Health, Living Standards.</p>

			Work, Justice and Security and Participation. <a href="https://gov.wales/socio-economic-duty-examples-inequalities-outcome">Examples https://gov.wales/socio-economic-duty-examples-inequalities-outcome</a>
--	--	--	---

<b>Human Rights</b>		No impact	See <a href="#">Human Rights Articles</a> . Consider intersectionality issues
<b>Other (please state)</b>		No impact	Eg, Modern Slavery, Safeguarding, Other Covid effects, Carers, Ex-offenders, Veterans, Care Leavers, Substance Abuse, Homeless Consider intersectionality issues

<b>Human Rights Act 1998</b>	<ul style="list-style-type: none"> <li>• Article 2 Right to life</li> <li>• Article 3 Freedom from torture and inhuman or degrading treatment</li> <li>• Article 4 Freedom from Slavery and forced labour</li> <li>• Article 5 Right to liberty and security</li> <li>• Article 6 Right to a fair trial</li> <li>• Article 7 No punishment without law</li> </ul>	<ul style="list-style-type: none"> <li>• Article 8 Respect for private life, family, home and correspondence</li> <li>• Article 9 Freedom of thought, belief and religion</li> <li>• Article 10 Freedom of expression</li> <li>• Article 11 Freedom of Assembly and association</li> <li>• Article 12 Right to marry and start a family</li> <li>• Article 13 Right to access effective remedy if rights are violated</li> <li>• Article 14 Protection from discrimination</li> </ul>
------------------------------	---	---

Tudalen 431

**Are there any data or information gaps and if so what are they and how do you intend to address them?**

None

Note: If it is not possible to obtain this information now, you should include this in your action plan in Step 6 so that this information is available for future EqlAs.

**10. If this EqlA is being updated from a previous version of a similar policy or practice, were the intended outcomes of the proposal last time achieved or were there other outcomes?** (Please provide details, for example, was the impact confined to the people you initially thought would be affected, or were other people affected and if so, how?)

N/A

**11. What does your proposal include to demonstrate you have given due regard to the Public Sector Equality Duty (to advance equality of opportunity; help to eliminate unlawful discrimination, harassment, or victimisation and foster good relations and wider community cohesion; as covered by the 3 aims of the General Duty in the Equality Act 2010)?**

We have recognised the existing problems cause by A frame access barriers to some mobility aids and commissioned a report to understand the constraints and opportunities that can be employed to improve access. This resulted in recommendations to improve access with a radar lockable gate to improve access whilst still retain control and management of illegal vehicle use which does protect the wider community in terms of safety.

12. **How does your proposal demonstrate you have given due regard to the need to address inequalities of outcome as a result of socio-economic disadvantage? (Please note that this is about closing inequality gaps rather than just improving outcomes for everyone.)**

N/A

13. **How does your proposal ensure that you are working in line with the requirements of the Welsh Language Standards (Welsh Language Measure (Wales) 2011), to ensure the Welsh language is not treated less favourably than the English language, and to ensure people can use the Welsh Language when accessing public services. Also how to operate to ensure that every opportunity is taken to promote the Welsh language (beyond providing services bilingually) and to increase opportunities to use and learn the language in the community?**

N/A

14. **What is the cumulative impact of this proposal on different protected groups when considering other key decisions affecting these groups made by the organisation? (You may need to discuss this with your Service Head or Cabinet Member to consider more widely if this proposal will affect certain groups more adversely because of other decisions the organisation is making, eg, financial impact/poverty, withdrawal of multiple services and whether this is disadvantaging the same groups, eg, disabled people, older people, single parents (who are mainly women), etc)**

This proposal does impact people with disability due to the control measure employed to combat illegal vehicle access. There is no access infrastructure which restricts illegal motorbike users whilst allowing legitimate users of mobility aids larger than a Class 2 mobility aid.

15. **How does this proposal meet with the 7 goals of the Well-being of Future Generations (Wales) Act 2015 including to create a More Equal Wales? (Summarise findings if you may have already considered this as part of the screening process)**



For more information, please see: [Wellbeing of Future Generations \(Wales\) Act 2015](#)

The proposal seeks to balance maximising accessibility as far as possible, whilst also seeking to manage anti-social behaviour and the risk to public safety public safety.

A Prosperous Wales – the project supports improvements to the Wales Coast Path which has been calculated to be worth £18.3m to the economy

A Resilient Wales – the project provides a level of resilience against antisocial behaviour.

A More Equal Wales – provides improvement to provide improved accessibility, although it may not be able to accommodate all requirements due to public safety concerns.

A Healthier Wales – will provide the opportunity for the majority of users to enjoy the Wales Coast Path providing health and well being benefits.

A Wales of Cohesive Communities – the scheme seeks to balance the need for access in addition to public safety

A Wales of Vibrant Culture & Thriving Welsh Language – any signage that might be installed in the future will embrace the Welsh language.

A Globally Responsible Wales – the Wales Coast Path provides the opportunity for people to walk and cycle rather than use vehicles, making a positive contribution to reducing emissions linked to climate change.

7. Describe any intended negative impact identified and explain why you believe this is justified (for example, on the grounds of advancing equality of opportunity or fostering good relations between those who share a protected characteristic and those who do not or because of an objective justification<sup>1</sup> or positive action<sup>2</sup>)

It is important on the grounds of public safety for the wider community, to retain the barriers to illegal vehicle access, this does have a negative impact on those with disability who need to use wide mobility aids. The proposed works have a positive effect in that it increases the number who can access the path through the radar locked gates, although some will find it difficult.

**Note<sup>1</sup>: Objective Justification** - gives a defence for applying a policy, rule or practice that would otherwise be unlawful direct or indirect discrimination. To rely on the objective justification defence, the employer, service provider or other organisation must show that its policy or rule was for a good reason – that is 'a proportionate means of achieving a legitimate aim'. A **legitimate aim** is the reason behind the discrimination which must not be discriminatory in itself and must be a genuine or real reason, eg, health, safety or welfare of individuals. If the aim is simply to reduce costs because it is cheaper to discriminate, this will not be legitimate. Consider if the importance of the aim outweighs any discriminatory effects of the unfavourable treatment and be sure that there are no alternative measures available that would meet the aim without too much difficulty (proportionate) and would avoid the discriminatory effect.

**Note<sup>2</sup>: Positive Action** - The Equality Act 2010 allows for positive action towards a specific group if there is sufficient evidence of need. For example, where an employer takes specific steps to improve equality in the workplace to address any imbalance of opportunity, lessen a disadvantage or increase participation in a particular activity, by, say, increasing the number of disabled people in senior roles where they are under-represented by targeting specific groups with job adverts or offering training to help create opportunities for certain groups. The public sector is expected to consider the use of positive action to help them comply with the Public Sector Equality Duty.

17. Could any of the negative impacts identified amount to unlawful discrimination but are perceived to be unavoidable (eg, reduction in funding)?

Yes  No  Not Sure  (Please double click on the relevant box (X) and select 'checked' as appropriate)

18. If you answered Yes or Not Sure to question 17, please state below, which protected group(s) or other groups this applies to and explain why (including likely impact or effects of this proposed change)

Disability  
To protect the wider community on the grounds of public safety due to the ongoing threat of illegal motobikes being used as part of 'county lines' drug routes into Wales.

19. If you answered No to question 17, are there any barriers identified which amount to a differential impact for certain groups and what are they?

Tudalen 434

### STEP 3 - Procurement and Partnerships

The Public Sector Equality Duty (PSED) requires all public authorities to consider the needs of protected characteristics when designing and delivering public services, including where this is done in partnership with other organisations or through procurement of services. The Welsh Language Standards also require all public authorities to consider the effects of any policy decision, or change in service delivery, on the Welsh language, which includes any work done in partnership or by third parties. We must also ensure we consider the Socio-economic Duty when planning major procurement and commissioning decisions to consider how such arrangements can reduce inequalities of outcome caused by socio-economic disadvantage.

When procuring works, goods or services from other organisations (on the basis of a relevant agreement), we must have due regard to whether it would be appropriate :

- for the award criteria for that contract to include considerations to help meet the General Duty (to eliminate discrimination, promote equality of opportunity and foster good relations);
- to stipulate conditions relating to the performance of the contract to help meet the three aims of the General Duty.

This only applies to contractual arrangements that are "relevant agreements" which means either the award of a 'public contract' or the conclusion of a 'framework agreement', both of which are regulated by the Public Sector Directive (Directive 2004/18/EC) which regulates the specified EU thresholds. Further information can be found [here](#).

We must consider how such arrangements can improve equal opportunities and reduce inequalities of outcome due to protected characteristics and caused by socio-economic disadvantage, particularly on major procurement and commissioning decisions. The PSED applies to the work that private sector organisations undertake when delivering a public function on our behalf. We therefore need to ensure that those organisations exercise those functions by ensuring our procurement and monitoring of those services complies with the General Duty under Section 149 of the Equality Act 2010. In the same way, the Welsh Language Standards applies to any work undertaken on behalf of, and in the name of, public bodies that are themselves subject to the Standards, and so consideration should be given to how these requirements are monitored and communicated through the procurement documents. The Socio Economic Duty does not pass to a third party through procurement, commissioning or outsourcing. Therefore when we work in partnership with bodies not covered by the Socio Economic Duty, the duty only applies to us as the relevant public body.

**20. Is this policy or practice to be carried out wholly or partly by contractors or in partnership with another organisation(s)?**

Yes  No  (Please double click on the relevant box (X) and select 'checked' as appropriate)

If No, please proceed to Step 4

**21. If Yes, what steps will you take to comply with the General Equality Duty, Human Rights and Welsh Language Legislation and the Socio-Economic Duty in regard to procurement and/or partnerships? Think about :**

Tudalen 435

**Procurement**

- Setting out clear equality expectations in Tendering and Specification documentation, showing how promotion of equality may be built into individual procurement projects
- On what you based your decisions in the award process, including consideration of ethnical employment and supply chain code of practice
- Ensure that contract clauses cover the Equality Act 2010 (Statutory Duties) (Wales) Regulations 2011 and socio-economic requirements as well as Welsh Language Duties (remember that any duties from the Welsh Language Measure 2011 and Welsh Language Standards are also applicable to services provided on your behalf under contract by external bodies).
- Performance and Monitoring measures are included to monitor compliance, managing and enforcing contracts

**Partnerships**

Be clear about who is responsible for :

- Equality Monitoring relevant data
- Equality Impact Assessments
- Delivering the actions from the EqIA
- Ensuring that equality, human rights and Welsh Language legislation is complied with by all partners
- Demonstrating due regard to the Public Sector Equality Duty and the Socio-Economic duty

## STEP 4 - Dealing with Adverse or Unlawful Impact and Strengthening the Policy or Practice

22. **When considering proportionality, does the policy or practice have a significantly positive or negative impact or create inequalities of outcome resulting from socio-economic disadvantage?** (Please give brief details)

Significantly positive impact	Significantly negative impact
There is a positive impact as the amended access point design allows better accessibility for those less able. The access point retains control over ingress of motorbikes and therefore wider public safety.	There is still a residual negative impact to some with disability who cannot access through a radar lockable gate.

23. **It is important that you record the mitigating actions you will take in developing your final policy/practice draft. Record here what measures or changes you will introduce to the policy or practice in the final draft which could reduce or remove any unlawful or negative impact or disadvantage and/or improve equality of opportunity/introduce positive change; or reduce inequalities of outcome resulting from socio-economic disadvantage?** (This could also inform the Action Plan in Q34)

Unlawful or Negative Impact Identified	Mitigation / Positive Actions Taken in the Policy/Practice	Completed (✓)
Access issues through radar lockable gate	Review the situation and issues for a 6 month period	

24. **Will these measures remove any unlawful impact or disadvantage?**

Yes  No  (Please double click on the relevant box (X) and select 'checked' as appropriate)

25. **If No, what actions could you take to achieve the same goal by an alternative means?**

None identified
-----------------

26. **What other measures or changes could you include to strengthen or change the policy/practice to demonstrate you have given due regard to the Public Sector Equality Duty?** (To advance equality of opportunity; help to eliminate unlawful discrimination,

harassment or victimisation; and foster good relations and wider community cohesion; as covered by the 3 aims of the General Duty in the Equality Act 2010)

None identified.

**27. What other measures or changes could you include to strengthen or change the policy/practice to demonstrate you have given due regard to the need to reduce inequalities of outcome as a result of socio-economic disadvantage?**

None identified.

**28. What other measures or changes could you include to strengthen or change the policy/practice to demonstrate you have given due regard to the need to increase opportunities for people to use the Welsh language, to ensure the Welsh language is not treated less favourably than the English language as set out in the Welsh Language (Wales) Measure 2011 and to reduce or prevent any adverse effects that the policy/practice may have on the Welsh language?**

N/A

**29. Do you have enough information to make an informed judgement?**

Yes  No  (Please double click on the relevant box (X) and select 'checked' as appropriate)

**30. If you answered Yes, please justify:**

Independent consultants review  
Feedback received from users and communities affected

**31. If you answered No, what information do you require and what do you need to do to make a decision?**

(Note: Should data collection be included in the action plan (Step 6)?)

**[You may need to stop here until you have obtained the additional information]**

T  
Total  
6437

## STEP 5 - Decision to Proceed

32. Using the information you have gathered in Steps 1 – 4 above, please state on the table below whether you are able to proceed with the policy or practice and if so, on what basis?

(Please double click on the relevant box (X) and select 'checked' as appropriate)

Decision	
<input checked="" type="checkbox"/> Yes	Continue with policy or practice in its current form
<input type="checkbox"/> Yes	Continue with policy or practice but with amendments for improvement or to remove any areas of adverse impact identified in Step 4
<input type="checkbox"/> Yes	Continue with the plan as any detrimental impact can be justified
<input type="checkbox"/> No	Do not continue with this policy or practice as it is not possible to address the adverse impact. Consider alternative ways of addressing the issues.

33. Are there any final recommendations in relation to the outcome of this Equality Impact Assessment?

None

## STEP 6 - Actions and Arrangements for Monitoring Outcomes and Reviewing Data

The EqIA process is an ongoing one that doesn't end when the policy/practice and EqIA is agreed and implemented. There is a specific legal duty to monitor the impact of policies/practices on equality on an ongoing basis to identify if the outcomes have changed since you introduced or amended this new policy or practice. If you do not hold relevant data, then you should be taking steps to rectify this in your action plan. To review the EHRC guidance on data collection you can review their [Measurement Framework](#).

34. Please outline below any actions identified in Steps 1-5 or any additional data collection that will help you monitor your policy/practice once implemented:

Action	Dates	Timeframe	Lead Responsibility	Add to Service Plan (✓)

35. Please outline below what arrangements you will make to monitor and review the ongoing impact of this policy or practice including timescales for when it should be formally reviewed:

Monitoring and Review arrangements (including where outcomes will be recorded)	Timeframe & Frequency	Lead Responsibility	Add to Service Plan (✓)
Monitor the installation and review in 6 months	30 <sup>th</sup> June	Tom Woodall	

**STEP 7 - Publishing the Equality Impact Assessment**

Please arrange for this completed EqIA to be agreed by your Head of Service/Department and arrange for translation and publishing with a copy sent to the Equality Officer -Fiona Mocko. [fiona.mocko@flintshire.gov.uk](mailto:fiona.mocko@flintshire.gov.uk) .

Tudalen 439

Mae'r dudalen hon yn wag yn bwrpasol



# Eitem ar gyfer y Rhaglen 16

## EXERCISE OF DELEGATED POWERS - DECISIONS TAKEN REPORTED TO CABINET – 16.01.24

### Housing and Communities

- **The Flintshire County Council – Prince’s Street, Primrose Street, Chapel Street, Dodd’s Drive and Summersville Close, Connah’s Quay – Proposed Prohibition of Waiting At Any Time**  
To advise Members of the unresolved matter(s) received following the advertisement of the proposed Prohibition of Waiting At Any Time on the roads listed above.

Copies of the Delegated Powers reports are retained by the Team Leader – Committee Services and available to view on request by Members.

Mae'r dudalen hon yn wag yn bwrpasol

**FLINTSHIRE COUNTY COUNCIL FORWARD WORK PROGRAMME ITEMS  
COUNCIL, CABINET, AUDIT AND GOVERNANCE & SCRUTINY  
1 January 2024 TO 30 June 2024**

COMMITTEE	MEETING DATE	CHIEF OFFICER PORTFOLIO	AGENDA ITEM & PURPOSE OF REPORT	REPORT TYPE (Strategic or Operational) (Cabinet only)	PORTFOLIO (Cabinet only)
January					
Environment & Economy Overview & Scrutiny Committee	9/01/24	Governance	<b>Forward Work Programme and Action Tracking (Env)</b> To consider the Forward Work Programme of the Environment	Operational	Cabinet Member for Governance and Corporate Services including Health and Safety and Human Resources
Environment & Economy Overview & Scrutiny Committee	9/01/24	Streetscene and Transportation	<b>Community Protection Warnings and Community Protection Notices</b> To brief Scrutiny on the use of Community Protection Warnings (CPWs) and Community Protection Notices (CPNs) to tackle environmental issues and persistent anti-social behaviour or nuisance that has a detrimental effect on the quality of life for residents.	Operational	Deputy Leader of the Council and Cabinet Member for Streetscene and the Regional Transport Strategy

Pudalen 443

Atodiad i'r Rhaglen

<b>COMMITTEE</b>	<b>MEETING DATE</b>	<b>CHIEF OFFICER PORTFOLIO</b>	<b>AGENDA ITEM &amp; PURPOSE OF REPORT</b>	<b>REPORT TYPE (Strategic or Operational) (Cabinet only)</b>	<b>PORTFOLIO (Cabinet only)</b>
Environment & Economy Overview & Scrutiny Committee	9/01/24	Streetscene and Transportation	<b>Fleet Contract</b> The report provides an update to Scrutiny on the Fleet Contract.	Operational	Deputy Leader of the Council and Cabinet Member for Streetscene and the Regional Transport Strategy
Environment & Economy Overview & Scrutiny Committee	9/01/24	Planning, Environment and Economy	<b>Ambition North Wales Q2 Report</b> To receive the Q2 performance report from Ambition North Wales.	Operational	Leader of the Council
Environment & Economy Overview & Scrutiny Committee	9/01/24	Streetscene and Transportation	<b>Streetlighting Policy</b> To provide an update following the conclusion of the public consultation and present the final draft of the strategy for adoption.	Operational	Deputy Leader of the Council and Cabinet Member for Streetscene and the Regional Transport Strategy
Environment & Economy Overview & Scrutiny Committee	9/01/24	Planning, Environment and Economy	<b>Bailey Hill Mold</b> To provide an update on the development of the facilities at Bailey Hill in Mold.	Operational	Cabinet Member for Climate Change and Economy

COMMITTEE	MEETING DATE	CHIEF OFFICER PORTFOLIO	AGENDA ITEM & PURPOSE OF REPORT	REPORT TYPE (Strategic or Operational) (Cabinet only)	PORTFOLIO (Cabinet only)
Community & Housing Overview & Scrutiny Committee	10/01/24	Housing and Communities	<p><b>Forward Work Programme and Action Tracking (CH &amp; E)</b></p> <p>To consider the Forward Work Programme of the Community &amp; Housing Overview &amp; Scrutiny Committee and to inform the Committee of progress against actions from previous meetings.</p>	Operational	
Community & Housing Overview & Scrutiny Committee	10/01/24	Housing and Communities	<p><b>Alarm Service Charges Review</b></p> <p>To outline the proposal to achieve full cost recovery for the Housing Revenue Account alarms service.</p>	Operational	Cabinet Member for Housing and Regeneration
Community & Housing Overview & Scrutiny Committee	10/01/24	Housing and Communities	<p><b>Welsh Housing Quality Standards (WHQS) 2023</b></p> <p>To provide an update on the new Welsh Housing Quality Standards (WHQS) 2023 and the Council's obligations relating to delivery of the new standards.</p>	Operational	Cabinet Member for Housing and Regeneration

Tuedden 449

COMMITTEE	MEETING DATE	CHIEF OFFICER PORTFOLIO	AGENDA ITEM & PURPOSE OF REPORT	REPORT TYPE (Strategic or Operational) (Cabinet only)	PORTFOLIO (Cabinet only)
Community & Housing Overview & Scrutiny Committee	10/01/24	Housing and Communities	<b>Car Parking Provision – Council owned properties</b> To provide an overview of Council’s Environmental Programme which includes the provision of car parking at Council owned properties.	Operational	Cabinet Member for Housing and Regeneration
Community & Housing Overview & Scrutiny Committee Tabled 446	10/01/24	Housing and Communities	<b>Housing Management and Anti-Social Behaviour Policy</b> To provide an overview of the changes that have been made to the Housing Management Policy and the Anti-Social Behaviour Policy in response to the Renting Homes Wales Act 2016.	Strategic	Cabinet Member for Housing and Regeneration
Community & Housing Overview & Scrutiny Committee	10/01/24	Housing and Communities	<b>Cost of Living and Welfare Reform</b> To update on the impacts of welfare reforms and the work that is ongoing to mitigate the impacts.	Operational	Cabinet Member for Housing and Regeneration
Corporate Resources Overview & Scrutiny Committee	11/01/24	Governance	<b>Action Tracking</b> To inform the Committee of progress against actions from previous meetings.	Operational	

COMMITTEE	MEETING DATE	CHIEF OFFICER PORTFOLIO	AGENDA ITEM & PURPOSE OF REPORT	REPORT TYPE (Strategic or Operational) (Cabinet only)	PORTFOLIO (Cabinet only)
Corporate Resources Overview & Scrutiny Committee	11/01/24	Governance	<b>Council Tax Reform – Welsh Government Phase 2 Consultation</b> To provide the Committee with information and a recommended response to the Welsh Government phase 2 consultation on Council Tax Reform.	Operational	Cabinet Member for Finance, Inclusion, Resilient Communities including Social Value and Procurement
Corporate Resources Overview & Scrutiny Committee	11/01/24	Social Services	<b>Joint Funded Care Packages - Update Report</b> To share an update on the current situation on the long term debt with the Betsi Cadwaladr University Health Board since the last report was received.	Operational	Deputy Leader of the Council and Cabinet Member for Social Services and Wellbeing
Corporate Resources Overview & Scrutiny Committee	11/01/24	Governance	<b>Forward Work Programme</b> To consider the Forward Work Programme of the Corporate Resources Overview & Scrutiny Committee.	Operational	

FD/001/en 447

COMMITTEE	MEETING DATE	CHIEF OFFICER PORTFOLIO	AGENDA ITEM & PURPOSE OF REPORT	REPORT TYPE (Strategic or Operational) (Cabinet only)	PORTFOLIO (Cabinet only)
Corporate Resources Overview & Scrutiny Committee	11/01/24	Chief Executive's	<b>Medium Term Financial Strategy and Budget 2024/25</b> To update on the budget estimate for 2024/25 and the implications of the Welsh Local Government Provisional Settlement which was received on 20 December.	Strategic	Cabinet Member for Finance, Inclusion, Resilient Communities including Social Value and Procurement
Corporate Resources Overview & Scrutiny Committee	11/01/24	Finance	<b>Revenue Budget Monitoring 2023/24 (Month 8)</b> To provide Members with the Revenue Budget Monitoring 2023/24 (Month 8) Report and Significant Variances.	Operational	Cabinet Member for Finance, Inclusion, Resilient Communities including Social Value and Procurement
Cabinet	16/01/24	Planning, Environment and Economy	<b>Bailey Hill Mold</b> To provide an update on the development of the facilities at Bailey Hill in Mold.	Operational	Cabinet Member for Climate Change and Economy

Tudalen 1748



COMMITTEE	MEETING DATE	CHIEF OFFICER PORTFOLIO	AGENDA ITEM & PURPOSE OF REPORT	REPORT TYPE (Strategic or Operational) (Cabinet only)	PORTFOLIO (Cabinet only)
Cabinet	16/01/24	Chief Executive's	<p><b>Medium Term Financial Strategy and Budget 2024/25 – Welsh Local Government Provisional Settlement</b></p> <p>To update on the budget estimate for 2024/25 and the implications of the Welsh Local Government Provisional Settlement which was received on 20 December.</p>	Strategic	Cabinet Member for Finance, Inclusion, Resilient Communities including Social Value and Procurement
Tudalen 449 Cabinet	16/01/24	Streetscene and Transportation	<p><b>Fleet Contract Review</b></p> <p>To provide an update on the Fleet Contract.</p>	Operational	Deputy Leader of the Council and Cabinet Member for Streetscene and the Regional Transport Strategy
Cabinet	16/01/24	Housing and Communities	<p><b>Alarm Service Charges Review</b></p> <p>To outline the proposal to achieve full cost recovery for the Housing Revenue Account alarms service.</p>	Operational	Cabinet Member for Housing and Regeneration

COMMITTEE	MEETING DATE	CHIEF OFFICER PORTFOLIO	AGENDA ITEM & PURPOSE OF REPORT	REPORT TYPE (Strategic or Operational) (Cabinet only)	PORTFOLIO (Cabinet only)
Cabinet	16/01/24	Streetscene and Transportation	<b>Streetlighting Policy 2023-2028</b> To seek Cabinet approval of the Council's revised Street Lighting Policy	Strategic	Deputy Leader of the Council and Cabinet Member for Streetscene and the Regional Transport Strategy
Cabinet Tudalen 450	16/01/24	Chief Executive's	<b>Council Plan 2023/24 Mid-Year Performance Report</b> To review progress against the priorities identified within the Council Plan 2023/28.	Strategic	Cabinet Member for Governance and Corporate Services including Health and Safety and Human Resources
Cabinet	16/01/24	Chief Executive's	<b>Revenue Budget Monitoring 2023/24 (Month 8)</b> This regular monthly report provides the latest revenue budget monitoring position for 2023/24 for the Council Fund and Housing Revenue Account. The position is based on actual income and expenditure as at Month 8, and projects forward to year-end.	Operational	Cabinet Member for Finance, Inclusion, Resilient Communities including Social Value and Procurement



COMMITTEE	MEETING DATE	CHIEF OFFICER PORTFOLIO	AGENDA ITEM & PURPOSE OF REPORT	REPORT TYPE (Strategic or Operational) (Cabinet only)	PORTFOLIO (Cabinet only)
Cabinet	16/01/24	Streetscene and Transportation	<b>Unsafe Memorials in Flintshire Cemeteries</b> To seek approval for an alternative and permanent method of making memorials safe if the memorial is not repaired by the Registered Grave Owner as well as the removal / making safe of any broken kerb sets that have fallen into disrepair.	Operational	Deputy Leader of the Council and Cabinet Member for Streetscene and the Regional Transport Strategy
Cabinet	16/01/24	Housing and Communities	<b>Housing Management and Anti-Social Behaviour Policy</b> To provide an overview of the changes that have been made to the Housing Management Policy and the Anti-Social Behaviour Policy in response to the Renting Homes Wales Act 2016.	Strategic	Cabinet Member for Housing and Regeneration
Cabinet	16/01/24	Planning, Environment and Economy	<b>Access Barrier Review update</b> To agree the implementation of access improvements to the Wales Coast Path.	Operational	Cabinet Member for Climate Change and Economy

COMMITTEE	MEETING DATE	CHIEF OFFICER PORTFOLIO	AGENDA ITEM & PURPOSE OF REPORT	REPORT TYPE (Strategic or Operational) (Cabinet only)	PORTFOLIO (Cabinet only)
Cabinet	16/01/24	Planning, Environment and Economy	<b>Updated Contaminated Land Inspection Strategy</b> To approve the updated Contaminated Land Inspection Strategy.	Strategic	Cabinet Member for Planning, Public Health and Public Protection
Cabinet	16/01/24	Governance	<b>Council Tax Reform – Welsh Government Phase 2 Consultation</b> To provide Cabinet with information and a recommended response to the Welsh Government phase 2 consultation on Council Tax Reform	Operational	Cabinet Member for Finance, Inclusion, Resilient Communities including Social Value and Procurement
Social & Health Care Overview & Scrutiny Committee	18/01/24	Governance	<b>Forward Work Programme and Action Tracking (S &amp; H)</b> To consider the Forward Work Programme of the Social	Operational	Cabinet Member for Governance and Corporate Services including Health and Safety and Human Resources
Flintshire County Council	23/01/24	Chief Executive's	<b>Treasury Management Mid-Year Review 2023/24</b> To present to Members the draft Treasury Management Mid-Year Review for 2023/24		

COMMITTEE	MEETING DATE	CHIEF OFFICER PORTFOLIO	AGENDA ITEM & PURPOSE OF REPORT	REPORT TYPE (Strategic or Operational) (Cabinet only)	PORTFOLIO (Cabinet only)
Flintshire County Council	23/01/24	Chief Executive's	<p><b>Review of Polling Districts, Polling Places and Polling Stations</b></p> <p>To approve the recommendations of the review of polling districts, polling places and polling stations</p>		
TUDAGEN 454 Flintshire County Council	23/01/24	Chief Executive's	<p><b>Housing Revenue Account (HRA) 30 Year Financial Business Plan</b></p> <p>The purpose of this report is to present, for recommendation to Council, the Housing Revenue Account (HRA) Budget for 2024/25, the HRA Business Plan and the summary 30 year Financial Business Plan.</p>		
Flintshire County Council	23/01/24	Governance	<p><b>Town and Community Council Member of the Standards Committee</b></p> <p>To endorse the process for appointing a replacement Town and Community Member to the Standards Committee</p>		

COMMITTEE	MEETING DATE	CHIEF OFFICER PORTFOLIO	AGENDA ITEM & PURPOSE OF REPORT	REPORT TYPE (Strategic or Operational) (Cabinet only)	PORTFOLIO (Cabinet only)
Governance and Audit Committee	24/01/24	Planning, Environment and Economy	<b>Audit Wales Report - Social Enterprise</b> To provide an update on actions following receipt of the Audit Wales report on Social Enterprise.	Operational	
Governance and Audit Committee  Tudalen 455	24/01/24	Chief Executive's	<b>Treasury Management 2024/25 Strategy and Q3 Update 2023/24</b> (1) To present to Members the draft Treasury Management Strategy 2024/25 for comments and recommendations for approval to Cabinet (2) To provide an update on matters relating to the Council's Treasury Management Policy, Strategy and Practices to the end December 2023.	Strategic	Cabinet Member for Finance, Inclusion, Resilient Communities including Social Value and Procurement
Governance and Audit Committee	24/01/24	Governance	<b>Code of Corporate Governance</b> To endorse the review of the Code of Corporate Governance.	All Report Types	Cabinet Member for Governance and Corporate Services including Health and Safety and Human Resources

COMMITTEE	MEETING DATE	CHIEF OFFICER PORTFOLIO	AGENDA ITEM & PURPOSE OF REPORT	REPORT TYPE (Strategic or Operational) (Cabinet only)	PORTFOLIO (Cabinet only)
Governance and Audit Committee	24/01/24	Governance	<b>Forward Work Programme</b> To consider the Forward Work Programme of the Internal Audit Department.	All Report Types	Cabinet Member for Governance and Corporate Services including Health and Safety and Human Resources
Governance and Audit Committee Tudalen 456	24/01/24	Governance	<b>Governance and Audit Committee Action Tracking</b> To inform the Committee of the actions resulting from points raised at previous Governance and Audit Committee meetings.	All Report Types	Cabinet Member for Governance and Corporate Services including Health and Safety and Human Resources
Governance and Audit Committee	24/01/24	Governance	<b>Internal Audit Progress Report</b> To present to the Committee an update on the progress of the Internal Audit Department.	All Report Types	Cabinet Member for Governance and Corporate Services including Health and Safety and Human Resources



COMMITTEE	MEETING DATE	CHIEF OFFICER PORTFOLIO	AGENDA ITEM & PURPOSE OF REPORT	REPORT TYPE (Strategic or Operational) (Cabinet only)	PORTFOLIO (Cabinet only)
Governance and Audit Committee	24/01/24	Governance	<b>Risk Management Update</b> To be assured that the updated risk management framework is comprehensive and functional.	All Report Types	Cabinet Member for Governance and Corporate Services including Health and Safety and Human Resources
February					
Education, Youth & Culture Overview & Scrutiny Committee	1/02/24	Governance	<b>Forward Work Programme and Action Tracking (EY&amp; C)</b> To consider the Forward Work Programme of the Education Youth	Operational	Cabinet Member for Governance and Corporate Services including Health and Safety and Human Resources
Education, Youth & Culture Overview & Scrutiny Committee	1/02/24	Education and Youth	<b>Council Plan 2023-24 Mid-Year Performance Reporting (EYC OSC)</b> To review the levels of progress in the achievement of activities and performance levels identified in the Council Plan.	Operational	Cabinet Member for Education, Welsh Language, Culture and Leisure

COMMITTEE	MEETING DATE	CHIEF OFFICER PORTFOLIO	AGENDA ITEM & PURPOSE OF REPORT	REPORT TYPE (Strategic or Operational) (Cabinet only)	PORTFOLIO (Cabinet only)
Education, Youth & Culture Overview & Scrutiny Committee	1/02/24	Education and Youth	<b>Feedback from Youth Justice Service Peer review</b> To Provide Members with an overview of the outcomes from the recent peer review.	Operational	Cabinet Member for Education, Welsh Language, Culture and Leisure
Education, Youth & Culture Overview & Scrutiny Committee	1/02/24	Education and Youth	<b>Revision of Post 16 Strategy</b> To outline how the new national commission was developing.	Operational	Cabinet Member for Education, Welsh Language, Culture and Leisure
Education, Youth & Culture Overview & Scrutiny Committee	1/02/24	Education and Youth	<b>GCSE and A-Level Results</b> To provide the Committee with the GCSE and A-Level results across Flintshire from the summer 2023.	Operational	Cabinet Member for Education, Welsh Language, Culture and Leisure
Environment & Economy Overview & Scrutiny Committee	6/02/24	Governance	<b>Forward Work Programme and Action Tracking (Env)</b> To consider the Forward Work Programme of the Environment	Operational	Cabinet Member for Governance and Corporate Services including Health and Safety and Human Resources

Tudalen 1458

COMMITTEE	MEETING DATE	CHIEF OFFICER PORTFOLIO	AGENDA ITEM & PURPOSE OF REPORT	REPORT TYPE (Strategic or Operational) (Cabinet only)	PORTFOLIO (Cabinet only)
Environment & Economy Overview & Scrutiny Committee	6/02/24	Planning, Environment and Economy	<b>Audit Wales Assurance &amp; Risk Assessment Report – Carbon reduction plan</b> To acknowledge the outcome of the Audit Wales report and support action being taken to address its recommendation.	Strategic	Cabinet Member for Climate Change and Economy
Environment & Economy Overview & Scrutiny Committee	6/02/24	Streetscene and Transportation	<b>Workplace Recycling Regulations</b> To receive the latest update on the Workplace Recycling Regulations	Operational	Deputy Leader of the Council and Cabinet Member for Streetscene and the Regional Transport Strategy
Community & Housing Overview & Scrutiny Committee	7/02/24	Housing and Communities	<b>Forward Work Programme and Action Tracking (CH &amp; E)</b> To consider the Forward Work Programme of the Community	Operational	Cabinet Member for Housing and Regeneration
Corporate Resources Overview & Scrutiny Committee	8/02/24	Governance	<b>Action Tracking (CROSC)</b> To inform the Committee of progress against actions from previous meetings	Operational	Cabinet Member for Governance and Corporate Services including Health and Safety and Human Resources

COMMITTEE	MEETING DATE	CHIEF OFFICER PORTFOLIO	AGENDA ITEM & PURPOSE OF REPORT	REPORT TYPE (Strategic or Operational) (Cabinet only)	PORTFOLIO (Cabinet only)
Corporate Resources Overview & Scrutiny Committee	8/02/24	Governance	<b>Forward Work Programme (CROSC)</b> To consider the Forward Work Programme of the Corporate Resources O	Operational	Cabinet Member for Governance and Corporate Services including Health and Safety and Human Resources
Corporate Resources Overview & Scrutiny Committee Tuesday 1460	8/02/24	Governance	<b>Public Services Ombudsman for Wales Annual Letter 2022-23 and complaints made against Flintshire County Council during the first half of 2023-24</b> To share the Public Services Ombudsman for Wales (PSOW) Annual Letter 2022-23 for Flintshire County Council and an overview of the complaints received against Council services in the first half of 2023-24.	Operational	Cabinet Member for Governance and Corporate Services including Health and Safety and Human Resources

COMMITTEE	MEETING DATE	CHIEF OFFICER PORTFOLIO	AGENDA ITEM & PURPOSE OF REPORT	REPORT TYPE (Strategic or Operational) (Cabinet only)	PORTFOLIO (Cabinet only)
Corporate Resources Overview & Scrutiny Committee	8/02/24	Finance	<p><b>Revenue Budget Monitoring 2023/24 (Month 9) and Capital Programme Monitoring 2023/24 (Month 9)</b></p> <p>To provide the Revenue Budget Monitoring 2023/24 (Month 9) report and the Capital Programme 2023/24 (Month 9) report.</p>	Operational	Cabinet Member for Finance, Inclusion, Resilient Communities including Social Value and Procurement
Cabinet Tudalen 461	20/02/24	Planning, Environment and Economy	<p><b>Audit Wales Assurance &amp; Risk Assessment Report – Carbon reduction plan</b></p> <p>To acknowledge the outcome of the Audit Wales report and support action being taken to address its recommendation.</p>	Strategic	Cabinet Member for Climate Change and Economy
Cabinet	20/02/24	Streetscene and Transportation	<p><b>Waste and Recycling Collections on Unadopted Roads</b></p> <p>To provide proposals for a new policy for waste and recycling collections for properties on private or unadopted roads.</p>	Strategic	Deputy Leader of the Council and Cabinet Member for Streetscene and the Regional Transport Strategy

COMMITTEE	MEETING DATE	CHIEF OFFICER PORTFOLIO	AGENDA ITEM & PURPOSE OF REPORT	REPORT TYPE (Strategic or Operational) (Cabinet only)	PORTFOLIO (Cabinet only)
Cabinet	20/02/24	Streetscene and Transportation	<b>Workplace Recycling Regulations</b> To provide an overview of the workplace recycling reforms being implemented by Welsh Government.	Operational	Deputy Leader of the Council and Cabinet Member for Streetscene and the Regional Transport Strategy
Cabinet Tudalen 462	20/02/24	Chief Executive's	<b>Treasury Management Strategy 2024/25</b> To present to Members the draft Treasury Management Strategy 2024/25 for recommendation to Council.	Strategic	Cabinet Member for Finance, Inclusion, Resilient Communities including Social Value and Procurement
Cabinet	20/02/24	Chief Executive's	<b>Capital Programme Monitoring 2023/24 (Month 9)</b> To present the Month 9 Capital Programme information for 2023/24	Operational	Cabinet Member for Finance, Inclusion, Resilient Communities including Social Value and Procurement

COMMITTEE	MEETING DATE	CHIEF OFFICER PORTFOLIO	AGENDA ITEM & PURPOSE OF REPORT	REPORT TYPE (Strategic or Operational) (Cabinet only)	PORTFOLIO (Cabinet only)
Cabinet	20/02/24	Chief Executive's	<b>Revenue Budget Monitoring 2023/24 (Month 9)</b> This regular monthly report provides the latest revenue budget monitoring position for 2023/24 for the Council Fund and Housing Revenue Account. The position is based on actual income and expenditure as at Month 9, and projects forward to year-end.	Operational	Cabinet Member for Finance, Inclusion, Resilient Communities including Social Value and Procurement
T 463 Wiltshire County Council	20/02/24	Chief Executive's	<b>Treasury Management Strategy 2024/25</b> To present to Members the draft Treasury Management Strategy 2024/25		
Social & Health Care Overview & Scrutiny Committee	29/02/24	Governance	<b>Forward Work Programme and Action Tracking (S &amp; H)</b> To consider the Forward Work Programme of the Social	Operational	Cabinet Member for Governance and Corporate Services including Health and Safety and Human Resources
March					

COMMITTEE	MEETING DATE	CHIEF OFFICER PORTFOLIO	AGENDA ITEM & PURPOSE OF REPORT	REPORT TYPE (Strategic or Operational) (Cabinet only)	PORTFOLIO (Cabinet only)
Flintshire County Council	1/03/24	Governance	<p><b>Rolling Review of the Members Code of Conduct</b> To approve the changes to the Code of Conduct for Councillors that have been recommended by the Standards Committee as part of the rolling review of the Constitution.</p>		
Flintshire County Council	1/03/24	Governance	<p><b>Rolling Review of the Employees Code of Conduct</b> As part of the rolling review of the Constitution, we need to consider whether the Employees Code of Conduct needs any amendments to keep it up to date.</p>		
Flintshire County Council	1/03/24	Governance	<p><b>Committee Sizes and Political Balance</b> To consider setting Committee sizes to an odd number of seats and recalculating Political Balance to reflect the new sizes.</p>		

TJ  
464



COMMITTEE	MEETING DATE	CHIEF OFFICER PORTFOLIO	AGENDA ITEM & PURPOSE OF REPORT	REPORT TYPE (Strategic or Operational) (Cabinet only)	PORTFOLIO (Cabinet only)
Environment & Economy Overview & Scrutiny Committee	5/03/24	Governance	<b>Forward Work Programme and Action Tracking (Env)</b> To consider the Forward Work Programme of the Environment	Operational	Cabinet Member for Governance and Corporate Services including Health and Safety and Human Resources
Environment & Economy Overview & Scrutiny Committee	5/03/24	Streetscene and Transportation	<b>Outcome of Adoption of Local Toilet Strategy</b> To update members on the outcome.	Operational	Deputy Leader of the Council and Cabinet Member for Streetscene and the Regional Transport Strategy
Environment & Economy Overview & Scrutiny Committee	5/03/24	Planning, Environment and Economy	<b>Destination Management Plan</b> To seek approval for the draft Destination Management Plan.	Operational	Cabinet Member for Climate Change and Economy

COMMITTEE	MEETING DATE	CHIEF OFFICER PORTFOLIO	AGENDA ITEM & PURPOSE OF REPORT	REPORT TYPE (Strategic or Operational) (Cabinet only)	PORTFOLIO (Cabinet only)
Community & Housing Overview & Scrutiny Committee	6/03/24	Housing and Communities	<b>Forward Work Programme and Action Tracking (CH &amp; E)</b> To consider the Forward Work Programme of the Community & Housing Overview & Scrutiny Committee and to inform the Committee of progress against actions from previous meetings.	Operational	Cabinet Member for Housing and Regeneration
Corporate Resources Overview & Scrutiny Committee	7/03/24	Governance	<b>Action Tracking (CROSC)</b> To inform the Committee of progress against actions from previous meetings	Operational	Cabinet Member for Governance and Corporate Services including Health and Safety and Human Resources
Corporate Resources Overview & Scrutiny Committee	7/03/24	Chief Executive's	<b>Cambrian Aquatics</b> To provide an update on financial forecasts for Cambrian Aquatics and decide on action.	Strategic	Cabinet Member for Education, Welsh Language, Culture and Leisure

Tudalen 196

COMMITTEE	MEETING DATE	CHIEF OFFICER PORTFOLIO	AGENDA ITEM & PURPOSE OF REPORT	REPORT TYPE (Strategic or Operational) (Cabinet only)	PORTFOLIO (Cabinet only)
Corporate Resources Overview & Scrutiny Committee	7/03/24	Governance	<b>Information Rights Compliance Report</b> To provide information around monitoring performance against the requirements of the UK General Data Protection Regulation and Freedom of Information Act.	Operational	Cabinet Member for Governance and Corporate Services including Health and Safety and Human Resources
Corporate Resources Overview & Scrutiny Committee	7/03/24	Governance	<b>Forward Work Programme (CROSC)</b> To consider the Forward Work Programme of the Corporate Resources O & S Committee	Operational	Cabinet Member for Governance and Corporate Services including Health and Safety and Human Resources
Corporate Resources Overview & Scrutiny Committee	7/03/24	Social Services	<b>Social Value Update</b> To present an update report on social value.	Operational	Cabinet Member for Finance, Inclusion, Resilient Communities including Social Value and Procurement

Tudalen 467

COMMITTEE	MEETING DATE	CHIEF OFFICER PORTFOLIO	AGENDA ITEM & PURPOSE OF REPORT	REPORT TYPE (Strategic or Operational) (Cabinet only)	PORTFOLIO (Cabinet only)
Corporate Resources Overview & Scrutiny Committee	7/03/24	Finance	<b>Revenue Budget Monitoring 2023/24 (Month 10)</b> To provide Members with the Revenue Budget Monitoring 2023/24 (Month 10) Report and Significant Variances.	Operational	Cabinet Member for Finance, Inclusion, Resilient Communities including Social Value and Procurement
Cabinet	12/03/24	Planning, Environment and Economy	<b>Destination Management Plan</b> To seek approval for the draft Destination Management Plan.	Operational	Cabinet Member for Climate Change and Economy
Cabinet	12/03/24	Chief Executive's	<b>Cambrian Aquatics</b> To provide an update on financial forecasts for Cambrian Aquatics and decide on action.	Strategic	Cabinet Member for Education, Welsh Language, Culture and Leisure

Tudalen 468

COMMITTEE	MEETING DATE	CHIEF OFFICER PORTFOLIO	AGENDA ITEM & PURPOSE OF REPORT	REPORT TYPE (Strategic or Operational) (Cabinet only)	PORTFOLIO (Cabinet only)
Cabinet	12/03/24	Chief Executive's	<b>Revenue Budget Monitoring 2023/24 (Month 10)</b> This regular monthly report provides the latest revenue budget monitoring position for 2023/24 for the Council Fund and Housing Revenue Account. The position is based on actual income and expenditure as at Month 10, and projects forward to year-end.	Operational	Cabinet Member for Finance, Inclusion, Resilient Communities including Social Value and Procurement
Education, Youth & Culture Overview & Scrutiny Committee Tuesday 469	21/03/24	Governance	<b>Forward Work Programme and Action Tracking (EY&amp; C)</b> To consider the Forward Work Programme of the Education Youth	Operational	Cabinet Member for Governance and Corporate Services including Health and Safety and Human Resources
April					

COMMITTEE	MEETING DATE	CHIEF OFFICER PORTFOLIO	AGENDA ITEM & PURPOSE OF REPORT	REPORT TYPE (Strategic or Operational) (Cabinet only)	PORTFOLIO (Cabinet only)
Governance and Audit Committee	10/04/24	Governance	<b>Audit Wales Assurance and Risk Assessment Review Report 2021-22</b> To summarise the findings to Governance and Audit Committee of the detailed assurance and risk assessment work undertaken.	All Report Types	
Total May					
Education, Youth & Culture Overview & Scrutiny Committee	30/05/24	Governance	<b>Forward Work Programme and Action Tracking (EY&amp; C)</b> To consider the Forward Work Programme of the Education Youth	Operational	Cabinet Member for Governance and Corporate Services including Health and Safety and Human Resources
June					
Social & Health Care Overview & Scrutiny Committee	6/06/24	Governance	<b>Forward Work Programme and Action Tracking (S &amp; H)</b> To consider the Forward Work Programme of the Social	Operational	Cabinet Member for Governance and Corporate Services including Health and Safety and Human Resources

COMMITTEE	MEETING DATE	CHIEF OFFICER PORTFOLIO	AGENDA ITEM & PURPOSE OF REPORT	REPORT TYPE (Strategic or Operational) (Cabinet only)	PORTFOLIO (Cabinet only)
Environment & Economy Overview & Scrutiny Committee	11/06/24	Governance	<b>Forward Work Programme and Action Tracking (Env)</b> To consider the Forward Work Programme of the Environment	Operational	Cabinet Member for Governance and Corporate Services including Health and Safety and Human Resources
Environment & Economy Overview & Scrutiny Committee	11/06/24	Governance	<b>Forward Work Programme and Action Tracking (Env)</b> To consider the Forward Work Programme of the Environment	Operational	Cabinet Member for Governance and Corporate Services including Health and Safety and Human Resources
Community & Housing Overview & Scrutiny Committee	12/06/24	Governance	<b>Forward Work Programme and Action Tracking (CH &amp; E)</b> To consider the Forward Work Programme of the Community	Operational	Cabinet Member for Governance and Corporate Services including Health and Safety and Human Resources

COMMITTEE	MEETING DATE	CHIEF OFFICER PORTFOLIO	AGENDA ITEM & PURPOSE OF REPORT	REPORT TYPE (Strategic or Operational) (Cabinet only)	PORTFOLIO (Cabinet only)
Corporate Resources Overview & Scrutiny Committee	13/06/24	Governance	<b>Forward Work Programme (CROSC)</b> To consider the Forward Work Programme of the Corporate Resources O & S Committee	Operational	Cabinet Member for Governance and Corporate Services including Health and Safety and Human Resources
Corporate Resources Overview & Scrutiny Committee Tuesday 472	13/06/24	Governance	<b>Action Tracking (CROSC)</b> To inform the Committee of progress against actions from previous meetings	Operational	Cabinet Member for Governance and Corporate Services including Health and Safety and Human Resources
Corporate Resources Overview & Scrutiny Committee	13/06/24	People and Resources	<b>Employment and Workforce End of Year Update</b> To present end of year workforce statistics and their analysis.	Operational	Cabinet Member for Governance and Corporate Services including Health and Safety and Human Resources



COMMITTEE	MEETING DATE	CHIEF OFFICER PORTFOLIO	AGENDA ITEM & PURPOSE OF REPORT	REPORT TYPE (Strategic or Operational) (Cabinet only)	PORTFOLIO (Cabinet only)
Cabinet	18/06/24	Social Services	<b>Age-friendly Flintshire</b> To provide an update on the progress being made to develop age-friendly communities in Flintshire.	Operational	Cllr Christine Jones

Mae'r dudalen hon yn wag yn bwrpasol

# Eitem ar gyfer y Rhaglen 17

Yn rhinwedd paragraff(au) 14 of Part 4 of Schedule 12A  
o Ddeddf Llywodraeth Leol 1972.

Dogfen Gyfyngedig - Ni ddylid ei chyhoeddi

Mae'r dudalen hon yn wag yn bwrpasol

Yn rhinwedd paragraff(au) 14 of Part 4 of Schedule 12A  
o Ddeddf Llywodraeth Leol 1972.

Dogfen Gyfyngedig - Ni ddylid ei chyhoeddi

Mae'r dudalen hon yn wag yn bwrpasol

Yn rhinwedd paragraff(au) 14 of Part 4 of Schedule 12A  
o Ddeddf Llywodraeth Leol 1972.

Dogfen Gyfyngedig - Ni ddylid ei chyhoeddi

Mae'r dudalen hon yn wag yn bwrpasol



Yn rhinwedd paragraff(au) 14 of Part 4 of Schedule 12A  
o Ddeddf Llywodraeth Leol 1972.

Dogfen Gyfyngedig - Ni ddylid ei chyhoeddi

Mae'r dudalen hon yn wag yn bwrpasol

Yn rhinwedd paragraff(au) 14 of Part 4 of Schedule 12A  
o Ddeddf Llywodraeth Leol 1972.

Dogfen Gyfyngedig - Ni ddylid ei chyhoeddi

Mae'r dudalen hon yn wag yn bwrpasol

Yn rhinwedd paragraff(au) 14 of Part 4 of Schedule 12A  
o Ddeddf Llywodraeth Leol 1972.

Dogfen Gyfyngedig - Ni ddylid ei chyhoeddi

Mae'r dudalen hon yn wag yn bwrpasol

Yn rhinwedd paragraff(au) 14 of Part 4 of Schedule 12A  
o Ddeddf Llywodraeth Leol 1972.

Dogfen Gyfyngedig - Ni ddylid ei chyhoeddi

Mae'r dudalen hon yn wag yn bwrpasol