

Map 1 – Overview of work locations.

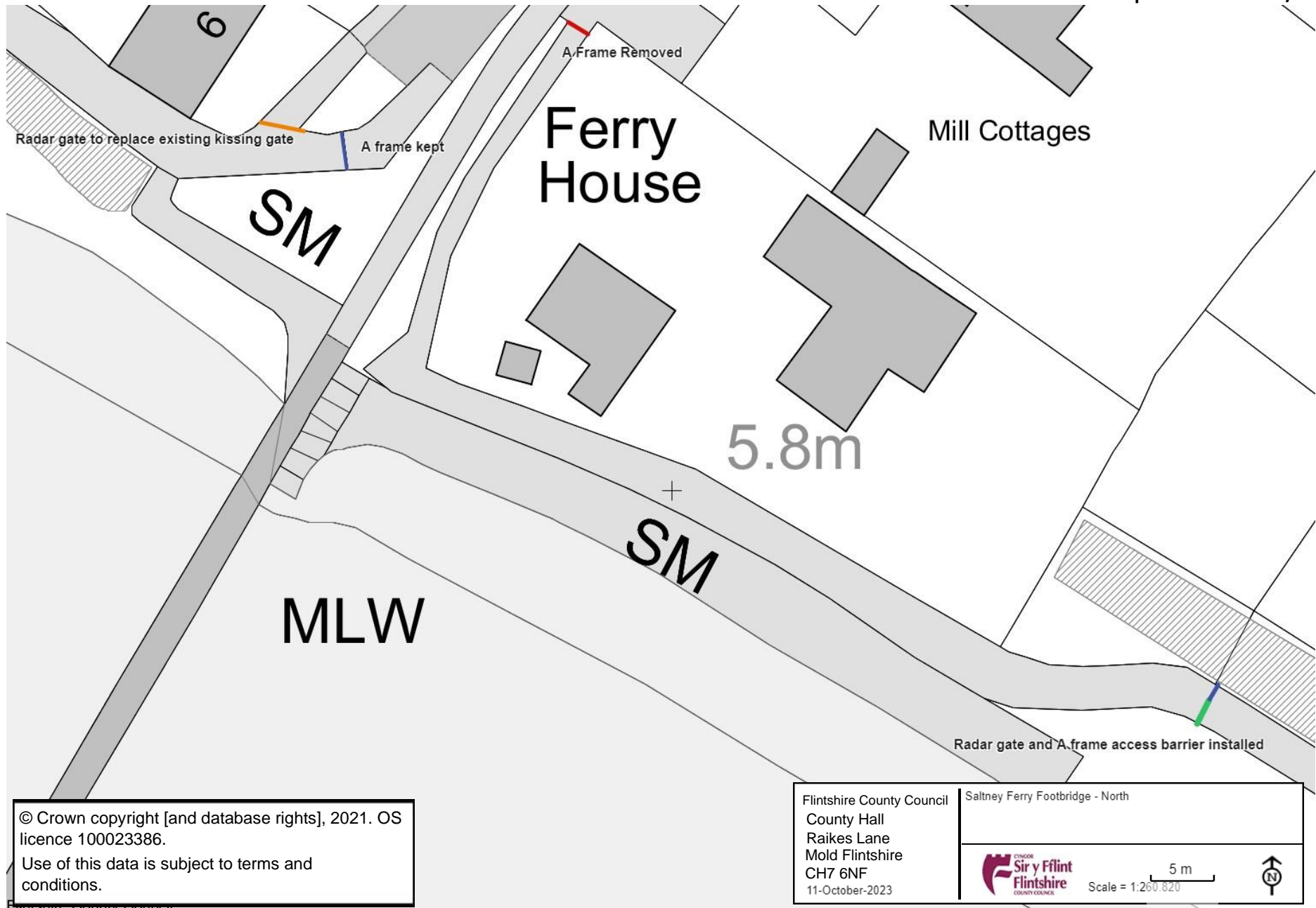

Map 2. Proposed works Saltney Ferry North

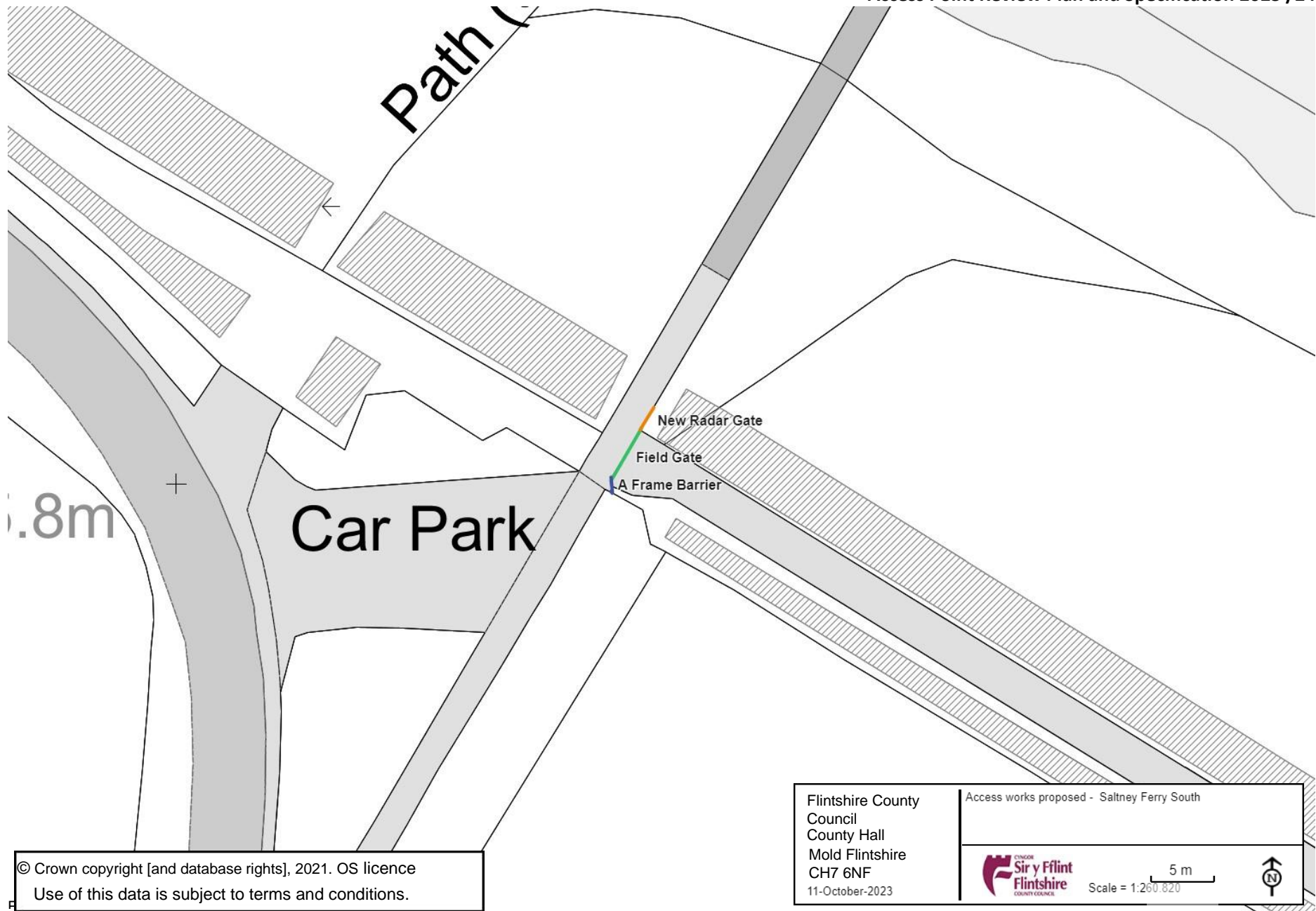

Map 3. Proposed works Saltney Ferry South

Radars Gate Specification

F010 2002 12



ITEM NO.	PART NUMBER	DESCRIPTION	QTY.
1	D010 2001 16	1500X1750 MARLOW 2 WAY GATE 'H' FRAME	1
2	D010 2001 14	1.2 PRT/MSH 2WAY MARLOW GATE C/W RADLOCK	1
3	B104 1220 42	M20X6in EYEBOLT GALV	1
4	F010 2002 54	MARLOW RADLOCK SLIDING BOLT	1
5	B001 3080 20	M8 X 20 SETSCREW BZP	2
6	B040 3002 08	M8 FULL NYLOC NUT TYPE T BZP	2
7	B003 2200 90	M20X90 BOLT GLV	1
8	B040 2002 20	M20 NYLOC NUT TYPE T	1
9	B106 0001 01	GATE CATCH PAWL (BARREL TYPE) GLV	1
10	B001 2080 30	M8 X 30 SETSCREW GALV	1
11	B040 2002 08	M8 FULL NYLOC NUT TYPE T GLV	1
12	B113 0005 01	RADAR PADLOCK TYPE A (2 LEVER) GALV	1
13	B051 3050 32	3/16 X 1 1/4in SELLOC PIN BZP	1
14	B111 0020 10	BADGE "CENTREWIRE" (50X20MM)	1
15	B117 8233 01	120 X 30 X 3mm BUTYL RUBBER STRIP	1
16	B021 3550 00	G16 BONDED WASHER (5.5mm DRILL SCREW)	2
17	B052 3148 11	4.8X12 LARGE FLANGE STEEL RIVET 1-6MM	2
18	B052 4032 08	3.2X8MM ALUMINIUM BLIND (POP) RIVET	2

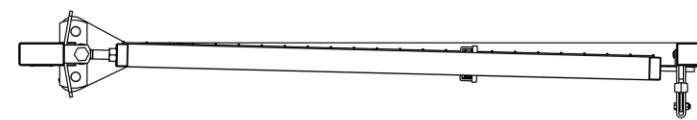
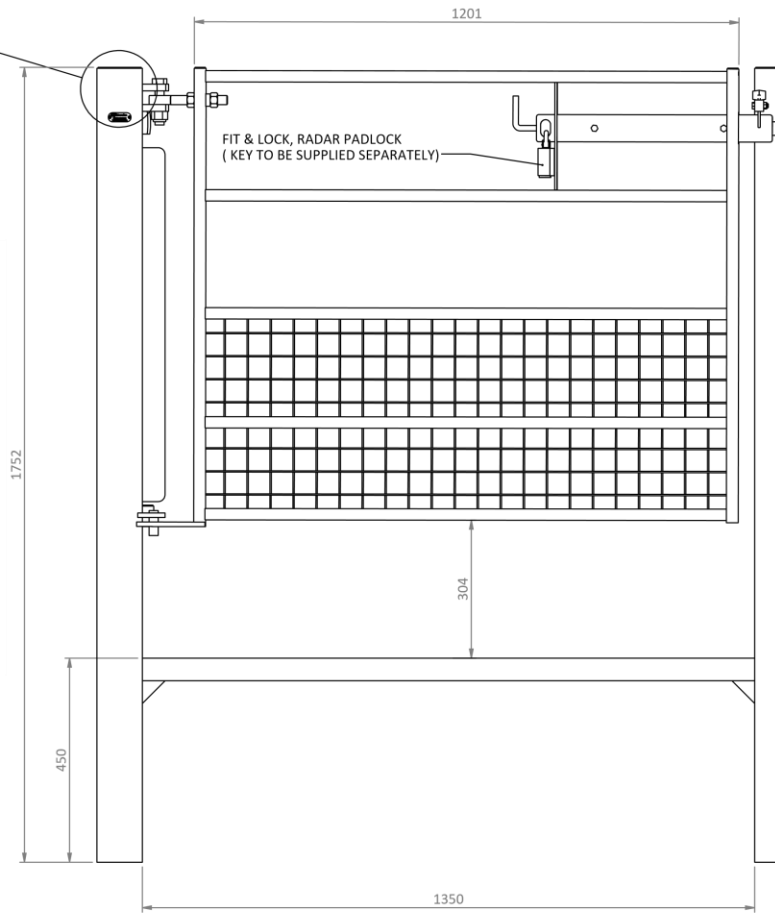
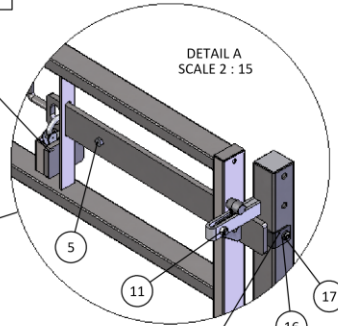
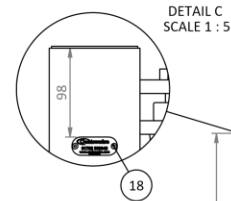
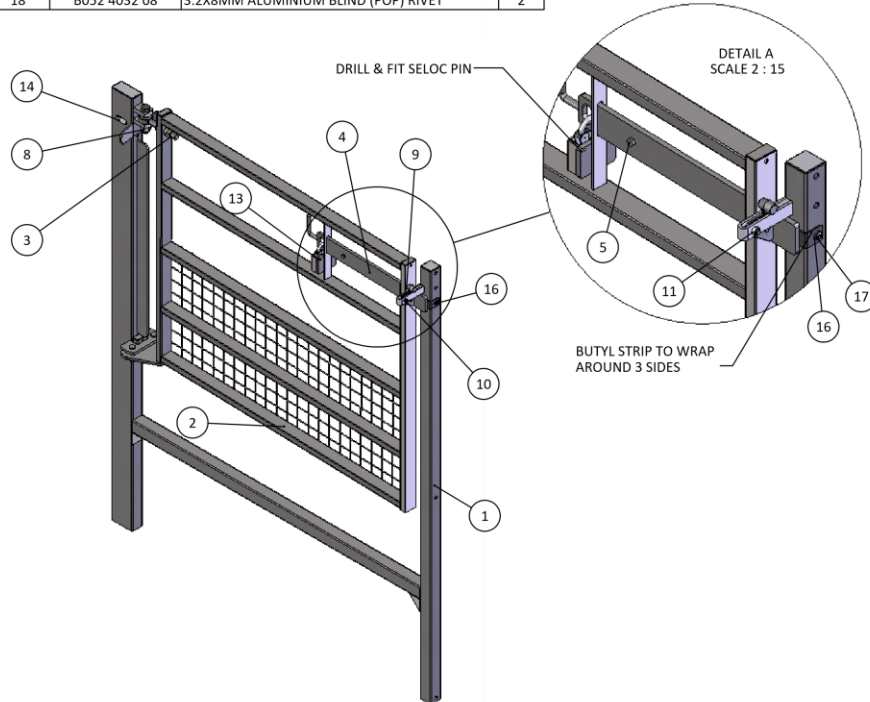

TITLE 1.2 PRT/MSH 2WAY MARLOW GATE C/W RADLOCK

PART No. F010 2002 12 Rev. A



THE INFORMATION CONTAINED IN THIS DRAWING IS THE PROPERTY OF "IAE". COPYRIGHT IS RESERVED BY THEM AND THE CONTENT USED ON THE CONDITION THAT IT IS NOT COPIED, REPRODUCED, RETAINED OR DISCLOSED TO ANY UNAUTHORISED PERSON EITHER WHOLLY OR IN PART WITHOUT THE CONSENT IN WRITING OF "IAE"

GENERAL NOTES		GENERAL TOLERANCES (UNLESS OTHERWISE STATED)	
1.REMOVE ALL BURRS & SHARP EDGES		BOUGHT IN	
2.ALL THREADS TO BE ISO METRIC COARSE		MADE IN HOUSE	
WELDING NOTES		REFER TO IAE TOLERANCE STDS	
1.FULLY WELD (UNLESS OTHERWISE STATED)		0 - 100 +/-0.25	
2.ALL WELDS TO BE FREE OF SPIKES & SPATTER		100 - 500 +/-0.5	
		500 + +/-1	
		ANGULAR +/-0.5°	
ALL DIMENSIONS ARE IN MILLIMETRES			
MATERIAL	Material <not specified>	A3	SCALE 1:20 DO NOT SCALE
FINISH	HOT DIP GALV	DRAWN	martinf
EST.NATURAL WEIGHT(kg.)	47.60	DATE	24/02/2011
		SHEET	1 OF 1
			IF IN DOUBT - ASK!

A	FIRST ISSUE	MM	24/10/2011
REV	DESCRIPTION	ECR	INT DATE

